

Technical data sheet

LOCC-Box Accessories

Labeling system
Labeling tags 5 × 5 mm
single signs

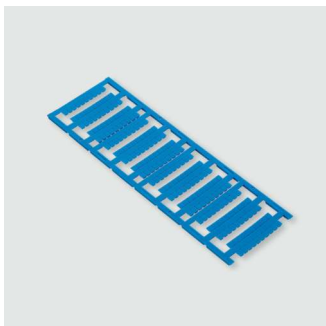

Identification

Type LOCC-Box-BZB 7-6433
Part No. [716433](#)

Product version

Datasheet version 02

Description

Description Terminal marker 5×5 mm, frame with 200 pieces, printable (Dekafix compatible)

General

Accessories	Labelling sign 5x5 mm blue
Design	200 tabs
Pin spacing	5 mm
Material	PA 6.6 (UL 94 V2)
Color	blue
Installation position	Any
Flamability according to UL 94	V2
Dimensions	5 × 5 mm
MTBF	690000 h
Weight/unit	0.01 kg
PU (units)	1

United Kingdom: LÜTZE Ltd.

Unit 3, Sandy Hill Park
Sandy Way, Amington • GB-Tamworth, Staffs B77 4DU
Tel. +44 (0)1827 31333-0 • Fax +44 (0)1827 31333-2
www.lutze.com • sales.gb@lutze.co.uk

Germany: Friedrich Lütze GmbH

Postfach 12 24 (PLZ 71366) • Bruckwiesenstraße 17-19 • D-71384 Weinstadt
Tel. +49 (0)7151 6053-0 • Fax +49 (0)7151 6053-277(-288)
www.luetze.de • info@luetze.de

04.08.2023 • Subject to technical modification

Part No. [716433](#) • Datasheet version: 02

page 1 of 4



SYSTEMATIC TECHNOLOGY

Technical data sheet

LOCC-Box Accessories

General ambient conditions

Operation temperature range -40 °C ... +100 °C
Storage temperature range -40 °C ... +100 °C

Certifications/Standards

Conformity RoHS
Certifications UL 94 V2

Notes and Comments

Note halogen-free

Dimensions

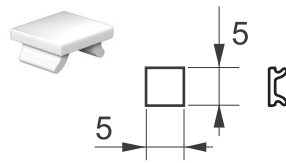

Use

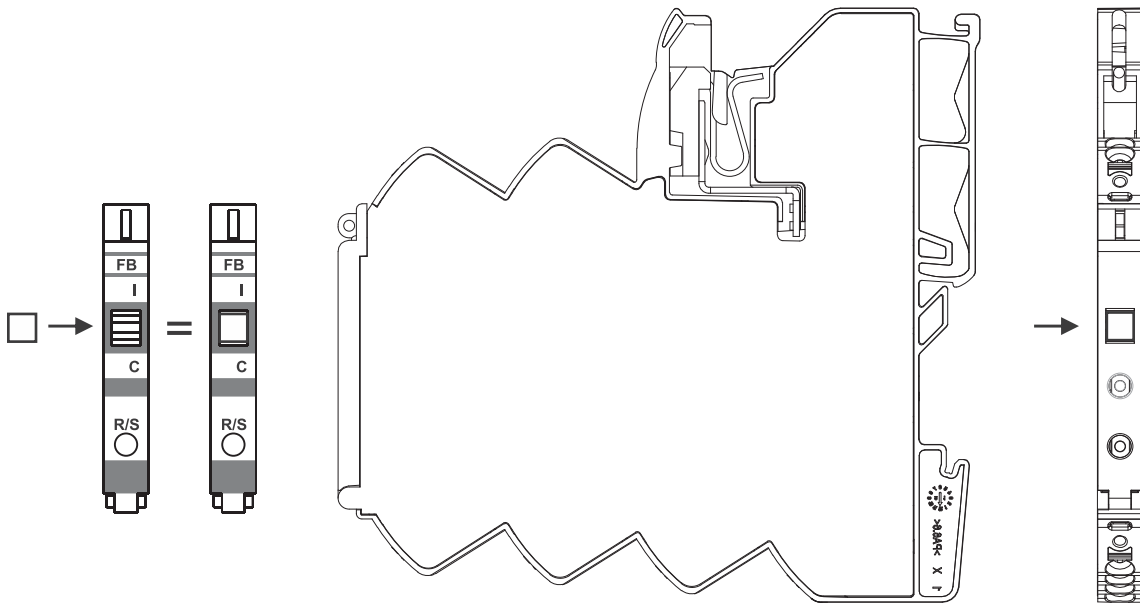

Use

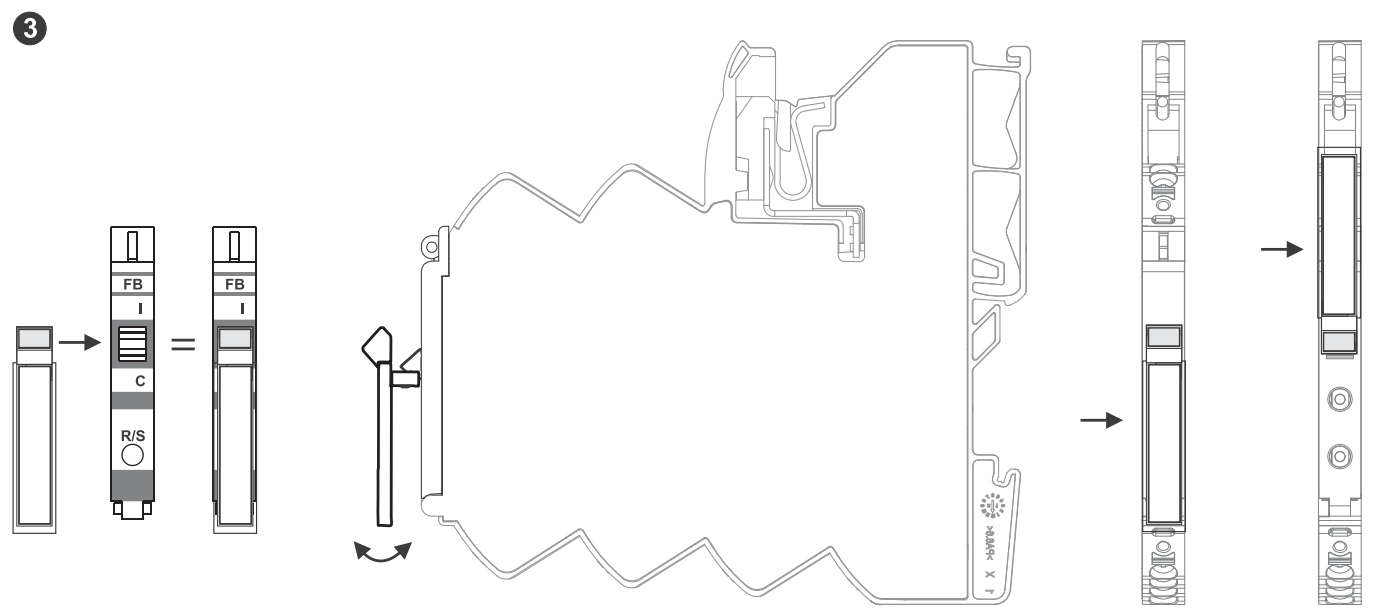
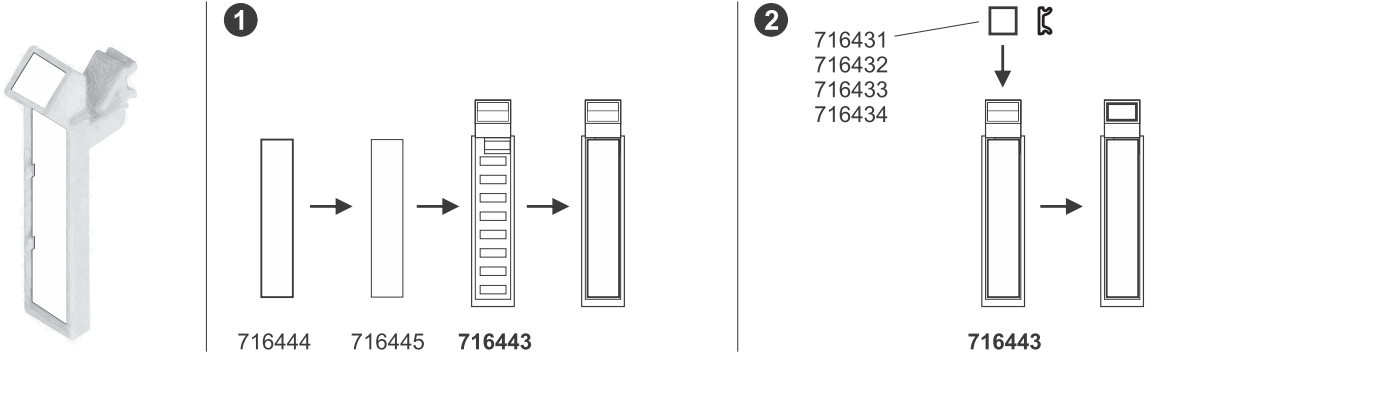

Use

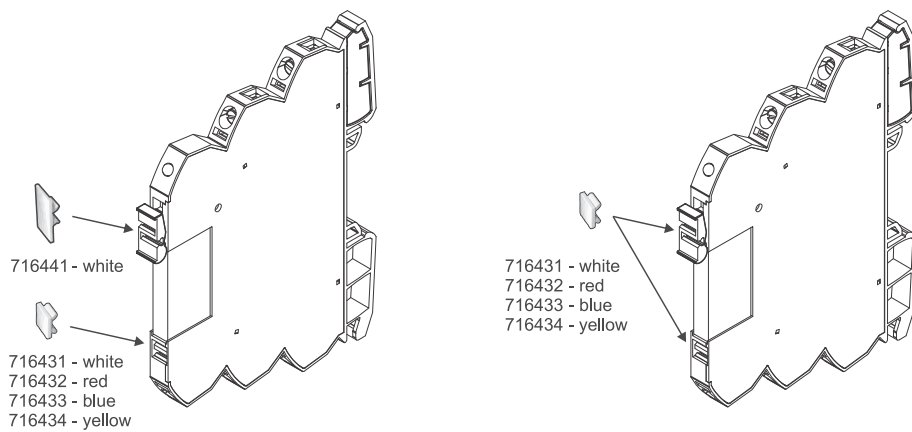

Use

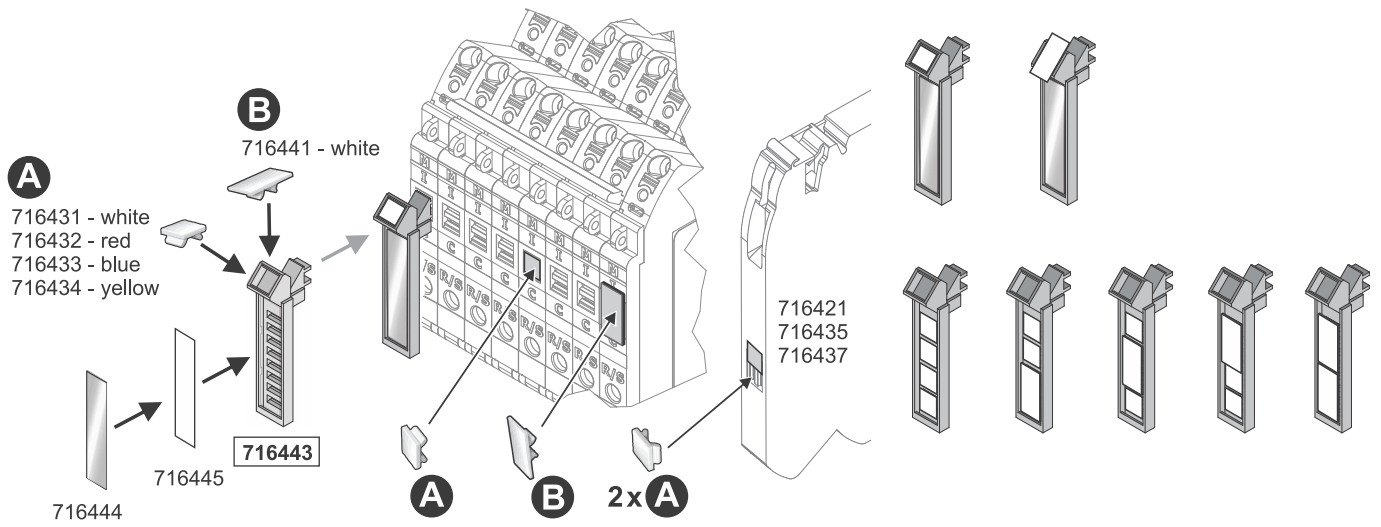

Use

