

Technical data sheet

Actuator sensor interface · M12 - connector

Field wireable connector, M12 angled

Female A-coded

Spring terminal: Push-in connection technology



Identification

Type KUWK-M12 5-POL-A FK
Part No. [490197](#)

Product version

Datasheet version 00

General

Design	M 12 female angle connector
Test voltage	1500 V
Degree of pollution	3
Insulation resistance	>100 M Ω
Contact resistance	<5 m Ω
Flamability according to UL 94	V0
Degree of protection	IP65, IP67 inserted and tightened
Housing material	PA 6.6
Color of the housing	black
Contact material	CuSn, gold-plated
Material knurled nut	Zinc die-casting, nickel-plated
Material sealing ring	NBR
Mounting	Coding can be rotated in the 45° increments
Cable diameter	4 mm – 8 mm
Storage temperature range	-40 °C ... +85 °C
Temperature range connector	-40 °C ... +85 °C

United Kingdom: LÜTZE Ltd.

Unit 3, Sandy Hill Park
Sandy Way, Amington • GB-Tamworth, Staffs B77 4DU
Tel. +44 (0)1827 31333-0 • Fax +44 (0)1827 31333-2
www.lutze.com • sales.gb@lutze.co.uk

Germany: Friedrich Lütze GmbH

Postfach 12 24 (PLZ 71366) • Bruckwiesenstraße 17-19 • D-71384 Weinstadt
Tel. +49 (0)7151 6053-0 • Fax +49 (0)7151 6053-277(-288)
www.luetze.de • info@luetze.de

21.04.2022 • Subject to technical modification

Part No. [490197](#) • Datasheet version: 00

page 1 of 3



SYSTEMATIC TECHNOLOGY

Technical data sheet

Actuator sensor interface · M12 - connector

Mechanical service life	>100 insertion cycles
Cross-section, metric	without ferrule: 0.14–0.75 mm ² with ferrule: 0.08–0.5 mm ²
Cross-section AWG	without ferrule: AWG26–AWG18 with ferrule: AWG28–AWG20
Connection type	Spring terminal Push-In
Tightening torque	M12-knurled nut: 0.4 Nm sleeve housing: 0.4 Nm pressure nut: 1.5 Nm
Weight/unit	0.022 kg
PU (units)	1

Technical data

Rated voltage U_N	AC/DC 24 V
Operating voltage max.	60 V
Rated current	4 A
Pole number	5
Coding	A

Certifications/Standards

Certifications	cULus Listed (E224249)
Standards	IEC 61076-2-101 EN 50155 (2001) vibration and shock

Dimensions

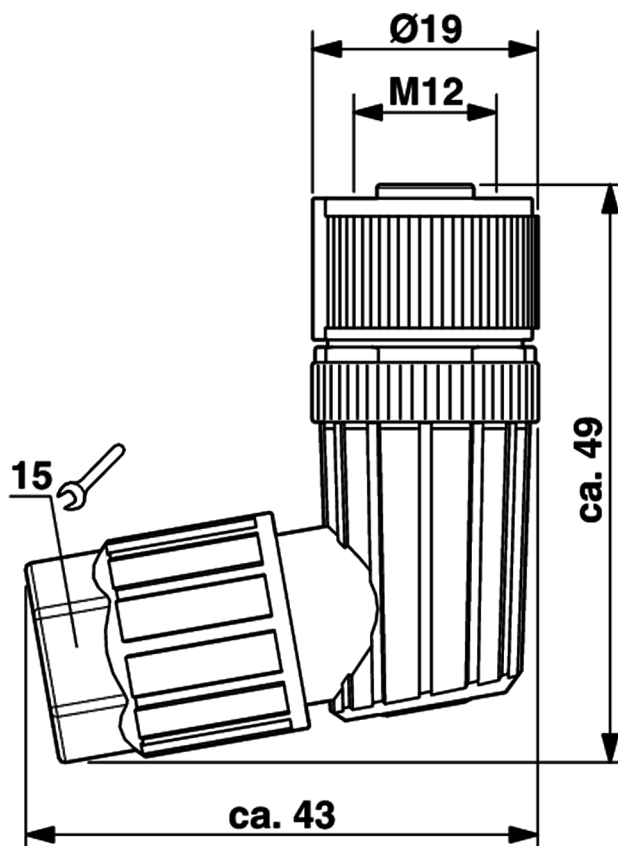

Technical data sheet

Actuator sensor interface · M12 - connector

Mounting diagram

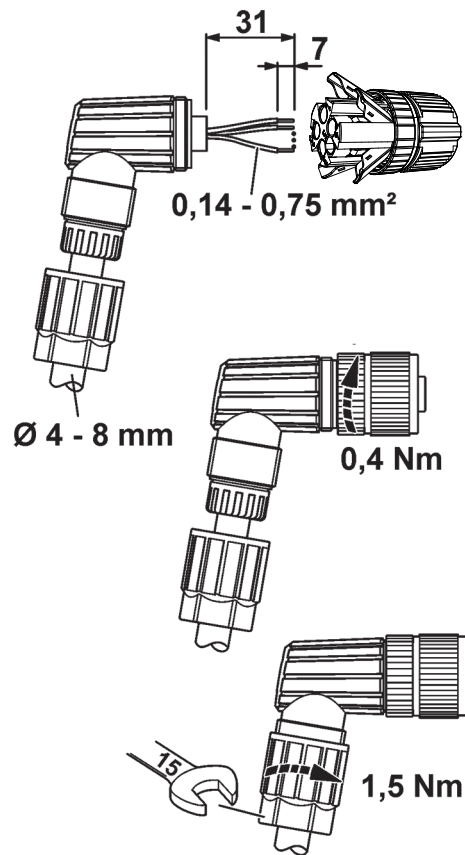

Pin layout

