

Technical data sheet

Actuator sensor interface · M8 – cables

Female M8 angled with PUR cable, open end
Self-locking screw connection
C-track compatible, halogen free



Identification

Type K UW3-M8 5M PUR
Part No. [474050](#)

Product version

Datasheet version 00

Use/Application/Properties

Properties

- Silicone free
- Free from paint wetting disruptive substances (LABS-free)
- Hydrolysis-resistant, microbe-resistant, and rot-resistant
- Resistance to acids, alkalines and watery solutions

General

Design	M 8×1
Form male 1	M 8 female angle connector
Form male 2	line end open
Rated insulation voltage	100 V
Test voltage	1500 V
Degree of pollution	3
Contact resistance	<5 mΩ
Flamability according to UL 94	HB
Degree of protection	IP65/67/68
Housing material	TPU
Color of the housing	black
Contact material	CuSn, gold-plated

United Kingdom: LÜTZE Ltd.

Unit 3, Sandy Hill Park
Sandy Way, Amington · GB-Tamworth, Staffs B77 4DU
Tel. +44 (0)1827 31333-0 · Fax +44 (0)1827 31333-2
www.lutze.com · sales.gb@lutze.co.uk

Germany: Friedrich Lütze GmbH

Postfach 12 24 (PLZ 71366) · Bruckwiesenstraße 17-19 · D-71384 Weinstadt
Tel. +49 (0)7151 6053-0 · Fax +49 (0)7151 6053-277(-288)
www.luetze.de · info@luetze.de

03.05.2022 · Subject to technical modification

Part No. [474050](#) · Datasheet version: 00

page 1 of 3



SYSTEMATIC TECHNOLOGY

Technical data sheet

Actuator sensor interface · M8 – cables

Thread material	Zinc die-casting, nickel-plated
Material sealing ring	NBR
Mounting	Breakaway torque 0.2 Nm
Number of conductors/cross-section	3 × 0.25 mm ² (32 × 0.1)
Number of conductors	3
Conductor color	black, blue, brown
Jacket material	PUR
Jacket color	black
Conductor insulation	PP
Cable diameter	3.6 mm
Minimum bending radius moving	10×D
Storage temperature range	-30 °C ... +90 °C
Temperature range connector	-25 °C ... +90 °C
Temperature range fixed	-40 °C ... +80 °C
Temperature range moving	-25 °C ... +80 °C
C-track chain properties	Type B
Conduction properties (TYPE A+B+C)	PUR halogen free for extreme demands Very good chemical stability Very resistant to oils and lubricants Very high abrasion resistance Halogen free Silicone free, free of paint wetting impairment substances Resistant to microbes and hydrolysis Good UV stability
Weight/unit	0.135 kg
PU (units)	1

Technical data

Rated voltage U _N	AC/DC 24 V
Operating voltage max.	48 V
Rated current	4 A
Pole number	3
Cable length	5 m
Coding	A

Certifications/Standards

UV-resistant according to Certifications	DIN EN ISO 4892-2-A cULus Listed (E224249)
--	---

Equipment/Spare parts

Accessories

Torque setting tool M 8: Part-No. 490090 | DM-SET M8 | PU: 1 unit

Technical data sheet

Actuator sensor interface · M8 – cables

Dimensions

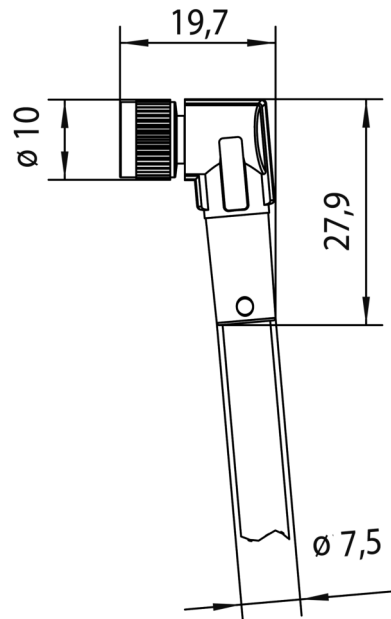

Pin layout

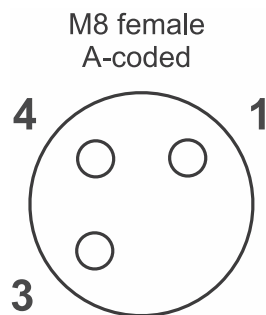

Circuit diagram

