

Technical data sheet - Module AirSTREAM

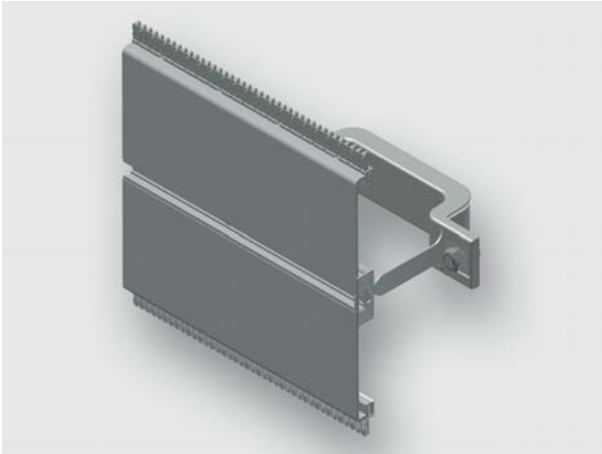

Standard module, pre-assembled from rail type MS and mounting bracket

Identification	Type	MS180 0900-0900 BI30-055
	Part-No.	380127M0002

Description	
Module type	MS180
Description	Installation rail MS module The standard module MS is used for mounting of components with screw channel on a flat surface. The module contains a symmetrically arranged screw channel, standard combs, two mounting brackets with insulation and edge protection. The MS module is available with a rail heights of 40 and 180 mm.

Technical data	
for frame width	900 mm
Frame width	900 mm
Frame depth	90 mm
Rail height	180 mm
Rail length	900 mm
Distance	50 mm
Bracket width	30 mm
Wiring space	55 cm ²
Top comb	Ja
Bottom comb	Ja

General

10.10.2019 – Subject to technical modification

Part-No. 380127M0002

USA: LUTZE INC.

13330 South Ridge Drive • Charlotte, NC 28273, USA
Tel. +1 (704) 504-0222 • Fax +1 (704) 504-0223
www.lutze.com • info@lutze.com

United Kingdom: LÜTZE Ltd.

Unit 3, Sandy Hill Park
Sandy Way, Amington • GB-Tamworth, Staffs B77 4DU
Tel. +44 (0)1827 31333-0 • Fax +44 (0)1827 31333-2
www.lutze.com • sales.gb@lutze.co.uk



SYSTEMATIC TECHNOLOGY

Technical data sheet - Module AirSTREAM

Material Aluminum
Surface bright

Dimensions

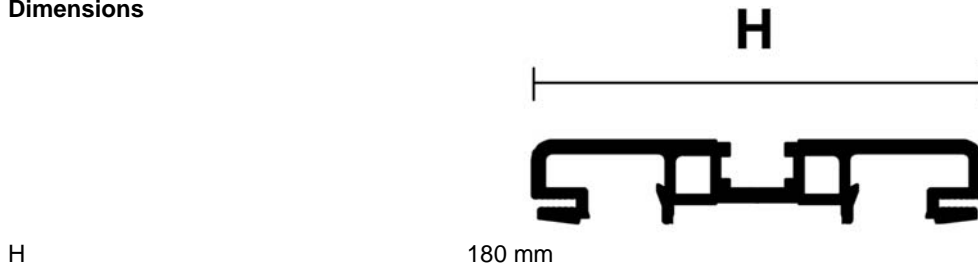

H

180 mm

10.10.2019 – Subject to technical modification

Part-No. 380127M0002

USA: LUTZE INC.

13330 South Ridge Drive • Charlotte, NC 28273, USA
Tel. +1 (704) 504-0222 • Fax +1 (704) 504-0223
www.lutze.com • info@lutze.com

United Kingdom: LÜTZE Ltd.

Unit 3, Sandy Hill Park
Sandy Way, Amington • GB-Tamworth, Staffs B77 4DU
Tel. +44 (0)1827 31333-0 • Fax +44 (0)1827 31333-2
www.lutze.com • sales.gb@lutze.co.uk



SYSTEMATIC TECHNOLOGY