

# Technical data sheet - Module AirSTREAM

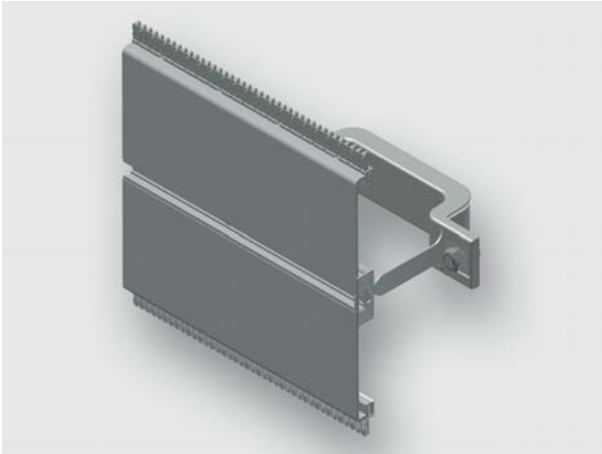

Standard module, pre-assembled from rail type MS and mounting bracket

<b>Identification</b>	Type	MS180 0500-0500 BI30-055
	Part-No.	380127M0000

<b>Description</b>	
Module type	MS180
Description	<b>Installation rail MS module</b> The standard module MS is used for mounting of components with screw channel on a flat surface. The module contains a symmetrically arranged screw channel, standard combs, two mounting brackets with insulation and edge protection. The MS module is available with a rail heights of 40 and 180 mm.

<b>Technical data</b>	
for frame width	500 mm
Frame width	500 mm
Frame depth	90 mm
Rail height	180 mm
Rail length	500 mm
Distance	50 mm
Bracket width	30 mm
Wiring space	55 cm <sup>2</sup>
Top comb	Ja
Bottom comb	Ja

## General

10.10.2019 – Subject to technical modification

Part-No. 380127M0000

USA: LUTZE INC.

13330 South Ridge Drive • Charlotte, NC 28273, USA  
Tel. +1 (704) 504-0222 • Fax +1 (704) 504-0223  
www.lutze.com • info@lutze.com

United Kingdom: LÜTZE Ltd.

Unit 3, Sandy Hill Park  
Sandy Way, Amington • GB-Tamworth, Staffs B77 4DU  
Tel. +44 (0)1827 31333-0 • Fax +44 (0)1827 31333-2  
www.lutze.com • sales.gb@lutze.co.uk



SYSTEMATIC TECHNOLOGY

## Technical data sheet - Module AirSTREAM

---

Material Aluminum  
Surface bright

---

### Dimensions

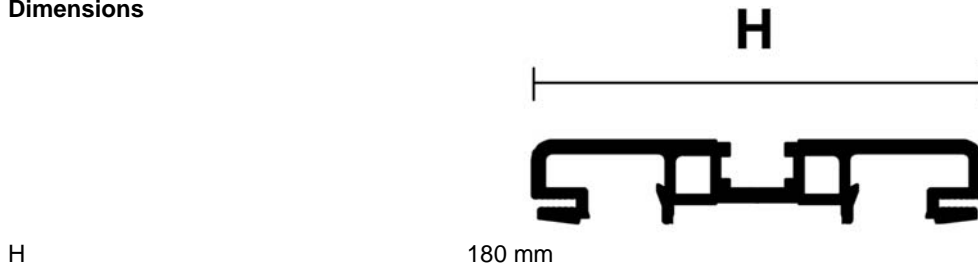

H

180 mm

10.10.2019 – Subject to technical modification

Part-No. 380127M0000

USA: LUTZE INC.

13330 South Ridge Drive • Charlotte, NC 28273, USA  
Tel. +1 (704) 504-0222 • Fax +1 (704) 504-0223  
www.lutze.com • info@lutze.com

United Kingdom: LÜTZE Ltd.

Unit 3, Sandy Hill Park  
Sandy Way, Amington • GB-Tamworth, Staffs B77 4DU  
Tel. +44 (0)1827 31333-0 • Fax +44 (0)1827 31333-2  
www.lutze.com • sales.gb@lutze.co.uk



SYSTEMATIC TECHNOLOGY