

Technical data sheet

Modular · 10 piece rail set

MS120 Rail set

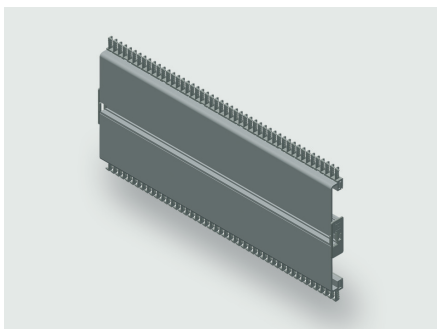

Identification

Type	MS120 750
Part-No.	380124R0750

Product version

Datasheet version	00
-------------------	----

Description

Module type	MS120
Description	The rail set contains 10 rails including edge protection, combs and mounting holes. Depending on the rail type and installation depth, brackets can be used for mounting. Brackets and mounting material is not included in the set. Other lengths in a 50 mm grid are available on request.

Technical data

Rail height	120 mm
Rail length	750 mm

General

Material	Aluminum
Surface	polished
PU (units)	10

Explanation

A	120 mm
---	--------

United Kingdom: LÜTZE Ltd.

Unit 3, Sandy Hill Park
Sandy Way, Amington • GB-Tamworth, Staffs B77 4DU
Tel. +44 (0)1827 31333-0 • Fax +44 (0)1827 31333-2
www.lutze.com • sales.gb@lutze.co.uk

Germany: Friedrich Lütze GmbH

Postfach 12 24 (PLZ 71366) • Bruckwiesenstraße 17-19 • D-71384 Weinstadt
Tel. +49 (0)7151 6053-0 • Fax +49 (0)7151 6053-277(-288)
www.luetze.de • info@luetze.de

22.04.2021 • Subject to technical modification
Part-No. 380124R0750 • Datasheet version: 00

Technical data sheet

Modular · 10 piece rail set

Dimensions

