

# Technical data sheet - Module AirSTREAM

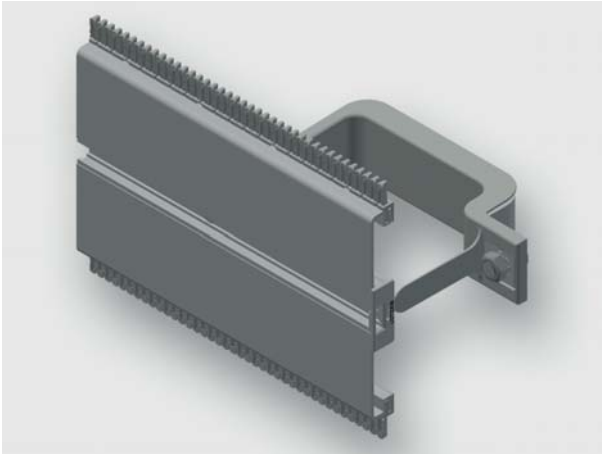

Standard module, pre-assembled from rail type MS and mounting bracket

<b>Identification</b>	Type	MS120 0700-0700 BI30-055
	Part-No.	380124M0001

<b>Description</b>	
Module type	MS120
Description	<b>Installation rail MS module</b> The standard module MS is used for mounting of components with screw channel on a flat surface. The module contains a symmetrically arranged screw channel, standard combs, two mounting brackets with insulation and edge protection. The MS module is available with a rail heights of 40 and 180 mm.

<b>Technical data</b>	
Frame width	700 mm
Frame depth	90 mm
Rail height	120 mm
Rail length	700 mm
Distance	50 mm
Bracket width	30 mm
Wiring space	55 cm <sup>2</sup>
Top comb	Ja
Bottom comb	Ja

<b>General</b>	
Material	Aluminum

10.10.2019 – Subject to technical modification

Part-No. 380124M0001

USA: LUTZE INC.

13330 South Ridge Drive • Charlotte, NC 28273, USA  
Tel. +1 (704) 504-0222 • Fax +1 (704) 504-0223  
www.lutze.com • info@lutze.com

United Kingdom: LÜTZE Ltd.

Unit 3, Sandy Hill Park  
Sandy Way, Amington • GB-Tamworth, Staffs B77 4DU  
Tel. +44 (0)1827 31333-0 • Fax +44 (0)1827 31333-2  
www.lutze.com • sales.gb@lutze.co.uk



SYSTEMATIC TECHNOLOGY

# Technical data sheet - Module AirSTREAM

---

Surface bright

---

## Dimensions

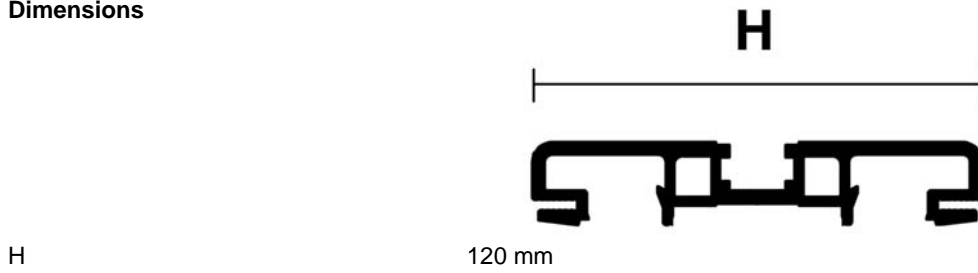

10.10.2019 – Subject to technical modification

Part-No. 380124M0001

USA: LUTZE INC.

13330 South Ridge Drive • Charlotte, NC 28273, USA  
Tel. +1 (704) 504-0222 • Fax +1 (704) 504-0223  
www.lutze.com • info@lutze.com

United Kingdom: LÜTZE Ltd.

Unit 3, Sandy Hill Park  
Sandy Way, Amington • GB-Tamworth, Staffs B77 4DU  
Tel. +44 (0)1827 31333-0 • Fax +44 (0)1827 31333-2  
www.lutze.com • sales.gb@lutze.co.uk