





RM85 faston miniature relays



- Cadmium - free contacts • Height 15,7 mm • 5000 V / 10 mm reinforced insulation • **Coil terminals for PCB, contacts terminals for PCB and flat insert connectors - faston 250 (6,3 x 0,8 mm), faston arrangement: vertical version (V) and horizontal version (H)** • DC coils - sensitive
- Ambient temperature up to 105 °C • Applications: for control of operation of heating elements and motors of household equipment and catering industry devices, for control of electromagnetic valves, in many other applications • Compliance with standard PN-EN 60335-1
- Recognitions, certifications, directives: RoHS,    

Contact data

Number and type of contacts		1 NO
Contact material		AgSnO₂
Rated / max. switching voltage	AC	250 V / 440 V
Min. switching voltage		10 V
Rated load (capacity)	AC1	20 A / 250 V AC
	AC15	3 A / 120 V 1,5 A / 240 V (B300)
	AC3	750 W (single-phase motor)
	DC1	20 A / 24 V DC
	DC13	0,22 A / 120 V 0,1 A / 250 V (R300)
Min. switching current		10 mA
Max. inrush current		30 A
Rated current		20 A
Max. breaking capacity	AC1	5 000 VA
Min. breaking capacity		1 W
Contact resistance		≤ 100 mΩ 100 mA, 24 V
Max. operating frequency		
• at rated load	AC1	600 cycles/hour
• no load		72 000 cycles/hour
Coil data		
Rated voltage	DC	5 ... 48 V
Must release voltage		DC: ≥ 0,1 U _n
Operating range of supply voltage		see Table 1
Rated power consumption	DC	0,25 W
Insulation according to PN-EN 60664-1		
Insulation rated voltage		400 V AC
Rated surge voltage		4 000 V 1,2 / 50 μs
Overvoltage category		III
Insulation pollution degree		3
Dielectric strength		
• between coil and contacts		5 000 V AC type of insulation: reinforced
• contact clearance		1 000 V AC type of clearance: micro-disconnection
Contact - coil distance		
• clearance		≥ 10 mm
• creepage		≥ 10 mm
General data		
Operating / release time (typical values)		8 ms / 3 ms
Electrical life (number of cycles)		
• resistive AC1		> 2 x 10 ⁴ 20 A, 250 V AC, 85 °C
		> 1,5 x 10 ⁵ 10 A, 250 V AC, 105 °C
• cosφ		see Fig. 1
Mechanical life (cycles)		> 3 x 10 ⁷
Dimensions (L x W x H)		vertical version (V): 40,5 x 12,7 x 15,7 mm
		horizontal version (H): 44,5 x 12,7 x 15,7 mm
Weight		16 g
Ambient temperature	• storage	-40...+105 °C
	• operating	-40...+105 °C
Cover protection category		IP 40 PN-EN 60529
Environmental protection		RTII PN-EN 116000-3
Shock resistance		30 g
Vibration resistance		10 g 10...150 Hz
Solder bath temperature		max. 270 °C
Soldering time		max. 5 s

The data in bold type pertain to the standard versions of the relays.

RM85 faston miniature relays

Coil data - DC voltage version, sensitive version

Table 1

Coil code	Rated voltage V DC	Coil resistance at 20 °C Ω	Acceptable resistance	Coil operating range V DC	
				min. (at 20 °C)	max. (at 20 °C)
S005	5	102	$\pm 10\%$	3,75	15,0
S006	6	144	$\pm 10\%$	4,50	18,0
S009	9	330	$\pm 10\%$	6,75	27,0
S010	10	380	$\pm 10\%$	7,50	30,0
S012	12	580	$\pm 10\%$	9,00	36,0
S018	18	1 300	$\pm 10\%$	13,50	54,0
S024	24	2 300	$\pm 10\%$	18,00	72,0
S048	48	9 340	$\pm 10\%$	36,00	144,0

The data in bold type pertain to the standard versions of the relays.

Dimensions

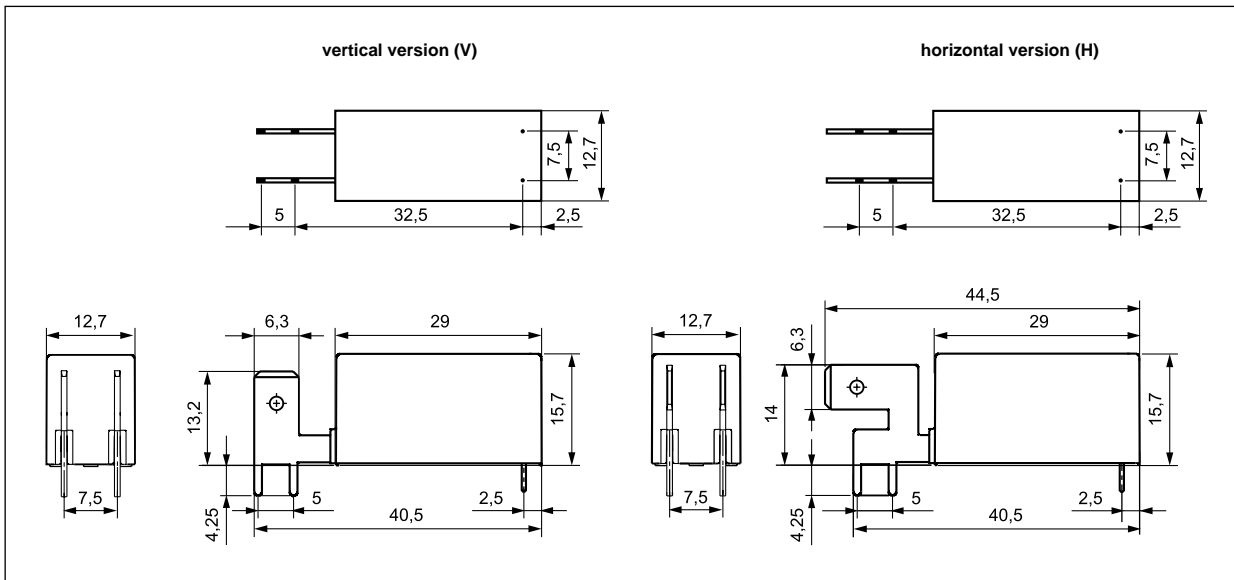

Connection diagram (pin side view)

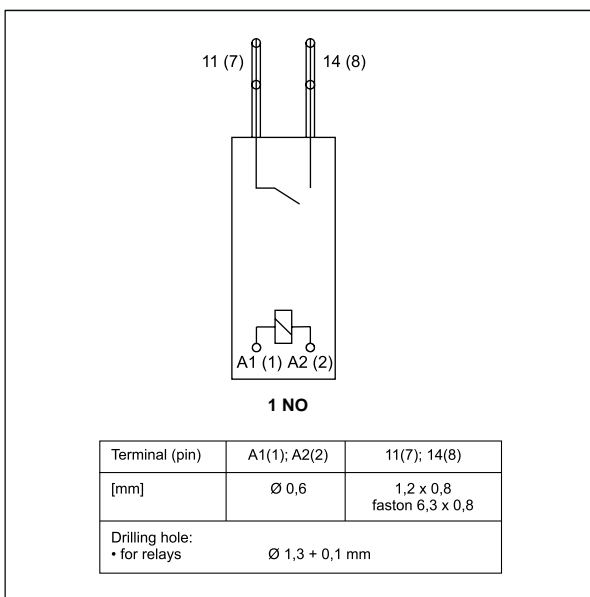

Electrical life reduction factor at AC inductive load

Fig. 1

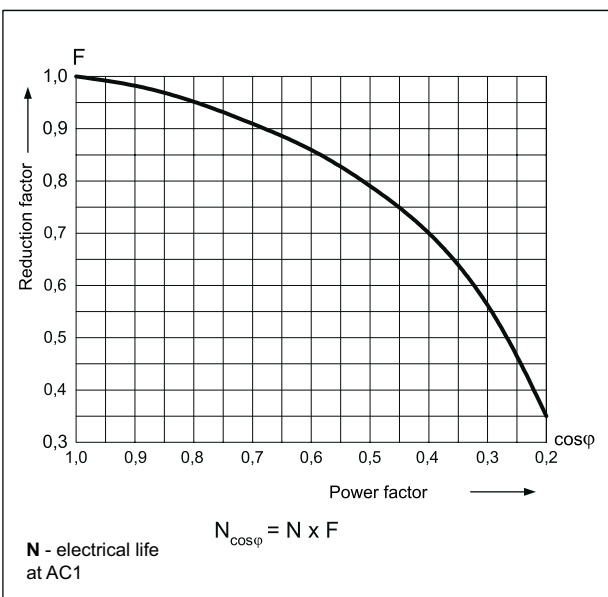

11.05.2013

RM85 faston miniature relays

Pinout (solder side view)

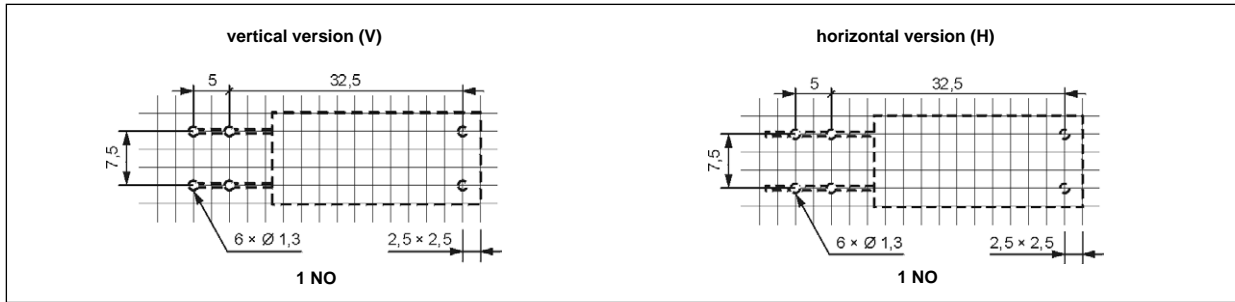

Mounting

Relays **RM85 faston** are designed for: • direct PCB mounting • connection of load with flat insert connectors - faston 250 (6,3 x 0,8 mm).

Ordering codes

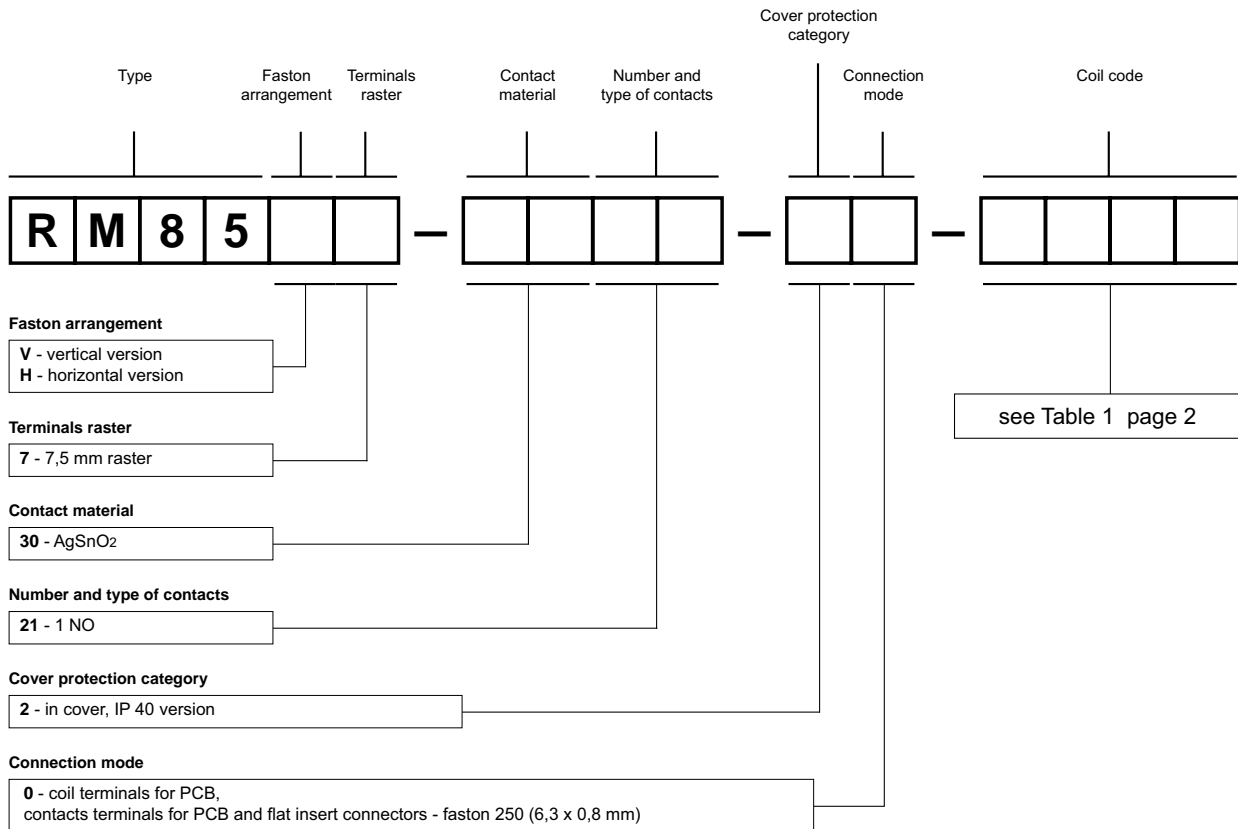

Example of ordering code:

RM85V7-3021-20-S012 relay **RM85 faston**, vertical version, coil terminals for PCB, contacts terminals for PCB and flat insert connectors - faston 250 (6,3 x 0,8 mm), 7,5 mm terminals raster, one normally open contact, contact material AgSnO₂, sensitive coil voltage 12 V DC, in cover IP 40

PRECAUTIONS:

1. Ensure that the parameters of the product described in its specification provide a safety margin for the appropriate operation of the device or system and never use the product in circumstances which exceed the parameters of the product. 2. Never touch any live parts of the device. 3. Ensure that the product has been connected correctly. An incorrect connection may cause malfunction, excessive heating or risk of fire. 4. In case of any risk of any serious material loss or death or injuries of humans or animals, the devices or systems shall be designed so to equip them with double safety system to guarantee their reliable operation.