

Ideal for compressor
and motor control
Inrush 80A,
1a 20A power relay

JM RELAYS

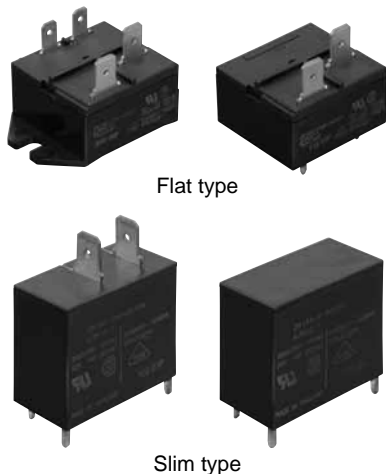

Flat type

Slim type

FEATURES

- **Compact, high-capacity, and resistant to inductive loads**
It can control an inductive load with inrush current of 80 A and steady state current of 20 A.
- **Excellent contact welding resistance**
High contact pressure, a forced opening mechanism, and a forced wiping mechanism realizes an excellent contact welding resistance.
- **High breakdown voltage and surge resistant relay**
More than 6.4 mm .252 inch maintained for the insulation distance between contacts and coil, and the breakdown voltage between contacts and coil is 5,000 V for 1 minute. In addition, the surge resistance between contacts and coil is greater than 10,000 V.
- **Resistant to external force**
An absorber mechanism is used on the load terminals, giving a large improvement in characteristics variations caused by the external force during FASTON placement/removal.
- **Flux resistance mechanism**
The terminal area is plugged with resin to prevent flux seepage during PCB mounting. (TMP type)

- **Conforms to the various safety standards**
UL, CSA, VDE available
- **The line up can support economical mounting methods.**
The relay are equipped with a drive terminal (coil terminal) on one side for PCBs, and a load terminal (tab terminal #250) on the reverse side. The line up includes the TM type which can be attached directly to the PCB composing a drive circuit, and the TMP type which supports economical wiring. The TMP type can also be directly attached, and a high capacity load can be wired to the tab terminal.

TYPICAL APPLICATIONS

- Compressor and heater control in air conditioners
- Power control in hot air type heaters
- Magnetron control in microwave ovens
- Lamp and motor control in OA equipment such as copiers and facsimiles.

RoHS compliant

ORDERING INFORMATION

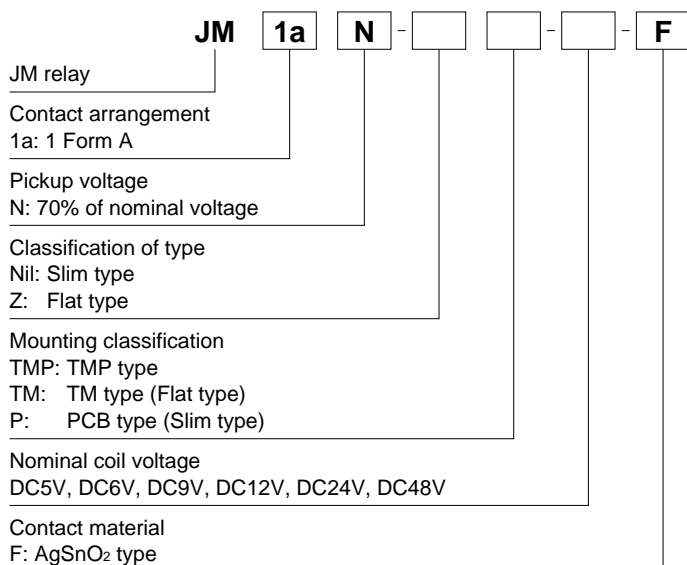

Note: Certified by UL, CSA and VDE

TYPES

Nominal coil voltage	Part No.			
	TMP type (Flat)	TM type (Flat)	TMP type (Slim)	PCB type (Slim)
5V DC	JM1aN-ZTMP-DC5V-F	JM1aN-ZTM-DC5V-F	JM1aN-TMP-DC5V-F	JM1aN-P-DC5V-F
6V DC	JM1aN-ZTMP-DC6V-F	JM1aN-ZTM-DC6V-F	JM1aN-TMP-DC6V-F	JM1aN-P-DC6V-F
9V DC	JM1aN-ZTMP-DC9V-F	JM1aN-ZTM-DC9V-F	JM1aN-TMP-DC9V-F	JM1aN-P-DC9V-F
12V DC	JM1aN-ZTMP-DC12V-F	JM1aN-ZTM-DC12V-F	JM1aN-TMP-DC12V-F	JM1aN-P-DC12V-F
24V DC	JM1aN-ZTMP-DC24V-F	JM1aN-ZTM-DC24V-F	JM1aN-TMP-DC24V-F	JM1aN-P-DC24V-F
48V DC	JM1aN-ZTMP-DC48V-F	JM1aN-ZTM-DC48V-F	JM1aN-TMP-DC48V-F	JM1aN-P-DC48V-F

Standard packing: Carton 50 pcs., Case 200 pcs.

RATING

1. Coil data

Nominal coil voltage	Pick-up voltage (at 20°C 68°F)	Drop-out voltage (at 20°C 68°F)	Nominal operating current [$\pm 10\%$] (at 20°C 68°F)	Coil resistance [$\pm 10\%$] (at 20°C 68°F)	Nominal operating power	Max. applied voltage (at 60°C 140°F)
5V DC	70%V or less of nominal voltage (Initial)	10%V or more of nominal voltage (Initial)	180 mA	27.8 Ω	900mW	110%V of nominal voltage
6V DC			150 mA	40 Ω		
9V DC			100 mA	90 Ω		
12V DC			75 mA	160 Ω		
24V DC			37.5 mA	640 Ω		
48V DC			18.75mA	2,560 Ω		

2. Specifications

Characteristics	Item	Specifications	
Contact	Contact material	AgSnO ₂ type	
	Arrangement	1 Form A	
	Contact resistance (Initial)	Max. 100 m Ω (By voltage drop 6 V DC 1A)	
Rating	Nominal switching capacity (resistive load)	20A 250V AC	
	Max. switching power (resistive load)	5,000VA	
	Max. switching voltage	250V AC	
	Max. switching current	20A	
	Min. switching capacity (reference value)*1	100mA, 5V DC	
Electrical characteristics	Insulation resistance (Initial)	Min. 100M Ω (at 500V DC) Measurement at same location as "Breakdown voltage" section.	
	Breakdown voltage (Initial)	Between open contacts	1,000 Vrms for 1 min. (Detection current: 10 mA)
		Between contact and coil	5,000 Vrms for 1 min. (Detection current: 10 mA)
	Temperature rise (coil)	Max. 55°C 131°F (By resistive method, nominal coil voltage applied to coil: 100%V, contact carrying current: 20A, at 60°C 140°F)	
	Surge breakdown voltage*2 (Between contact and coil) (Initial)	10,000 V	
	Operate time (at nominal voltage) (at 20°C 68°F)	Max. 20 ms (excluding contact bounce time.)	
Release time (at nominal voltage) (at 20°C 68°F)	Max. 10 ms (excluding contact bounce time) (Without diode)		
Mechanical characteristics	Shock resistance	Functional	98 m/s ² (Half-wave pulse of sine wave: 11 ms; detection time: 10 μ s.)
		Destructive	980 m/s ² (Half-wave pulse of sine wave: 6 ms.)
	Vibration resistance	Functional	10 to 55 Hz at double amplitude of 1.6 mm (Detection time: 10 μ s.)
		Destructive	10 to 55 Hz at double amplitude of 2 mm
Expected life	Mechanical (at 180 times/min.)	Min. 10 ⁶	
	Electrical (at 20 times/min.)	Min. 10 ⁵ (at nominal switching capacity)	
Conditions	Conditions for operation, transport and storage*3	Ambient temperature: -40°C to +60°C -40°F to +140°F, Humidity: 5 to 85% R.H. (Not freezing and condensing at low temperature)	
	Max. operating speed	20 times/min. (at nominal switching capacity)	
Unit weight		Slim TMP and Slim PCB: Approx. 28 g .99 oz Flat TMP: Approx. 30 g 1.06 oz Flat TM: Approx. 30 g 1.06 oz	

* Specifications will vary with foreign standards certification ratings.

Notes: *1. This value can change due to the switching frequency, environmental conditions, and desired reliability level, therefore it is recommended to check this with the actual load.

*2. Wave is standard shock voltage of $\pm 1.2 \times 50\mu$ s according to JEC-212-1981

*3. The upper limit of the ambient temperature is the maximum temperature that can satisfy the coil temperature rise value. Refer to Usage, transport and storage conditions in NOTES.

3. Switching capacity

Electrical Life	Resistive load	20 A, 250 V AC (cos ϕ = 1)	10 ⁵ (at 20 times/min.)
		Inductive load (cos ϕ = 0.7)	Inrush 70 A, Steady 20 A (250 V AC cos ϕ = 0.7)
	Inrush 80 A, Cut-off 80 A (When the motor is locked) (250 V AC cos ϕ = 0.7)		1.5 $\times 10^3$ (at 20 times/min.)

Note: Standard UL and CSA 1HP, 20A 250VAC 1 $\frac{1}{2}$ HP, 20A 125VAC

REFERENCE DATA

1. Coil temperature rise

Place to be measured: Inside of coil
 Ambient temperature: 25°C 77°F

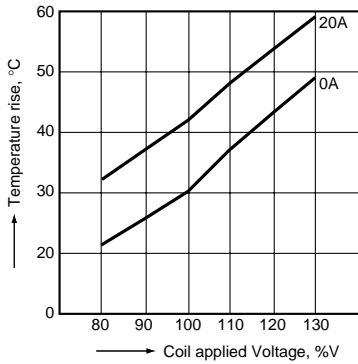

2. Life curve

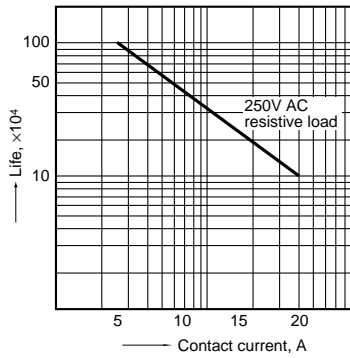

3. Operate/release time

Sample: JM1aN-TMP-DC24V-F, 5 pcs.

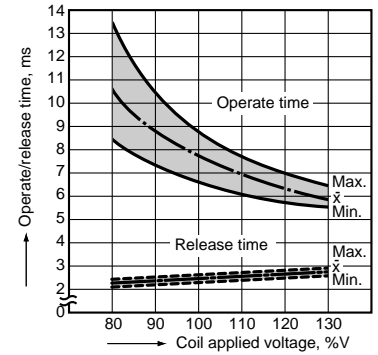

4. Ambient temperature characteristics

Sample: JM1aN-TMP-DC24V-F, 5 pcs.

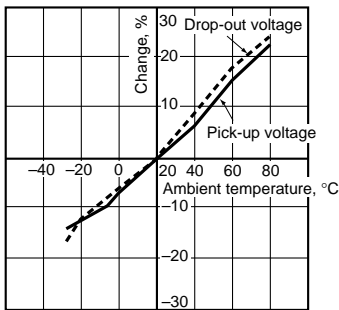

DIMENSIONS (mm inch)

The CAD data of the products with a **CAD Data** mark can be downloaded from: <http://industrial.panasonic.com/ac/e/>

Flat TMP type

CAD Data

External dimensions

Schematic

PC board pattern (Bottom view)

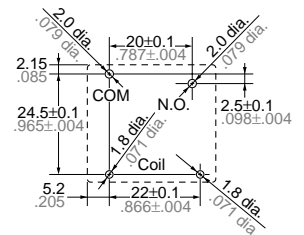
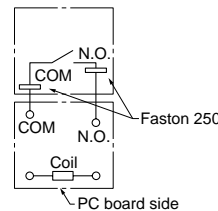
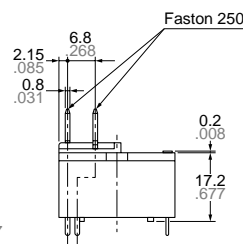
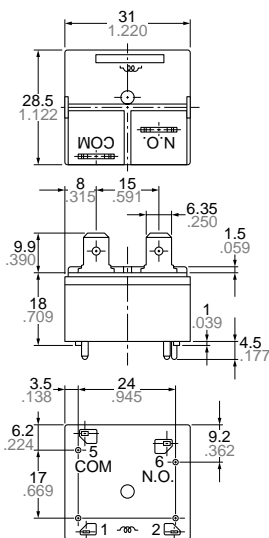

Tolerance: ±0.1 ±.004

General tolerance: ±0.4 ±.016

Flat TM type

CAD Data



External dimensions

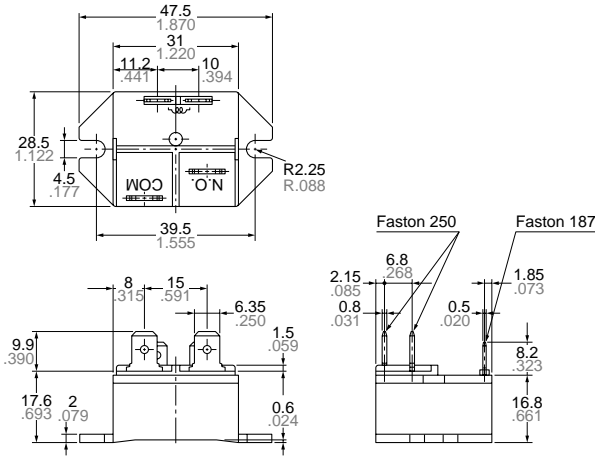

Schematic

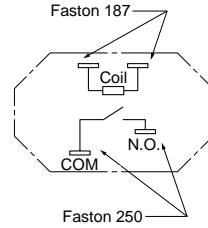

Panel cutout

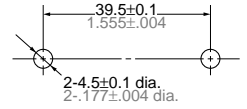

General tolerance: $\pm 0.4 \pm 0.16$

Slim TMP type

CAD Data



External dimensions

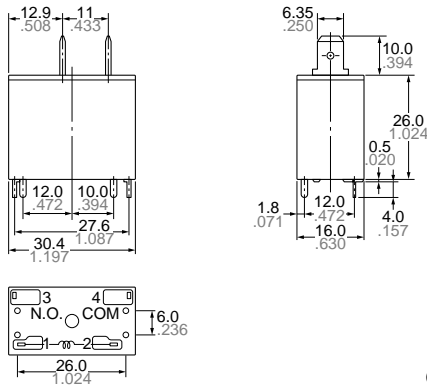

Schematic

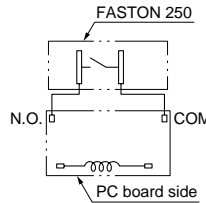

PC board pattern (Copper-side view)

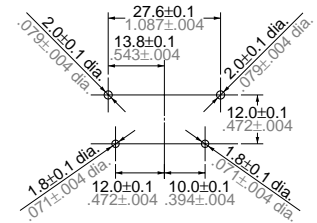

Tolerance: $\pm 0.1 \pm 0.04$

General tolerance: $\pm 0.4 \pm 0.16$

Slim PCB type

CAD Data



External dimensions

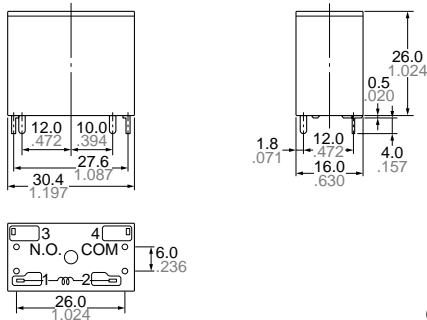

Schematic

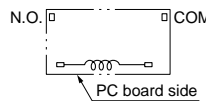

PC board pattern (Copper-side view)

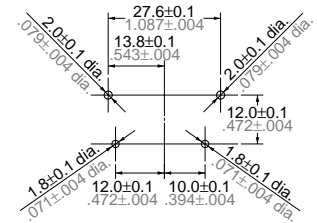

Tolerance: $\pm 0.1 \pm 0.04$

General tolerance: $\pm 0.4 \pm 0.16$

SAFETY STANDARDS

Item	UL/C-UL (Recognized)		CSA (Certified)		VDE (Certified)	
	File No.	Contact rating	File No.	Contact rating	File No.	Contact rating
Slim type	E43028	20A 125V AC 20A 250V AC 1½HP 125V AC 1HP 250V AC	LR26550	20A 125V AC 20A 250V AC 1½HP 125V AC 1HP 250V AC	40014275	20A 250V AC (cosφ=1.0) 12A 220V AC (cosφ=0.4)
Flat type	E43028	20A 125V AC 20A 250V AC 1½HP 125V AC 1HP 250V AC	LR26550	20A 125V AC 20A 250V AC 1½HP 125V AC 1HP 250V AC	40014275	20A 250V AC (cosφ=1.0) 12A 230V AC (cosφ=0.4)

For Cautions for Use.