

HFV9

AUTOMOTIVE RELAY



Typical Applications

Headlight control, Fuel pump control, Horn control, A/C compressor clutch

Features

- Extended temp. range up to 125°C
- 1 Form A & 1 Form C contact arrangement
- 2.8mm QC terminals
- RoHS & ELV compliant

CHARACTERISTICS

Contact arrangement	1A, 1C	Vibration	10Hz to 40Hz 1.27mm DA 40Hz to 70Hz 49m/s ² 70Hz to 100Hz 0.5mm DA 100Hz to 500Hz 98m/s ²
Voltage drop (initial)	NO:Typ.20mV,250mV max.(at 10A) NC:Typ.25mV,250mV max.(at 10A)	Flammability ⁶⁾	UL94-HB or better (meets FMVSS 302)
Max.continuous current ¹⁾⁸⁾	30A (at 125°C, 1h)	Termination	2.8mm QC
Max.switching current ⁸⁾	Make(NO): 100A ²⁾ Break(NO): 30A (Resistive, 13.5VDC)	Construction	Plastic sealed, Dust protected
Max. switching voltage	See "Load limit curve"	Unit weight	Approx. 20g
Min. contact load	1A 6VDC	Mechanical data	cover retention (pull & push): 200N min. terminal retention (pull & push): 100N min. terminal resistance to bending (front & side): 10N min. ⁷⁾
Electrical endurance	See "CONTACT DATA"		
Mechanical endurance	1x10 ⁷ OPS 300OPS/min		
Initial insulation resistance	100MΩ (at 500VDC)		
Dielectric strength ³⁾	between contacts: 500VAC between coil & contacts: 500VAC		
Operate time ⁸⁾	Typ.: 5ms (at nomi. vol.) Max.: 10ms (at nomi. vol.)		
Release time ⁴⁾⁸⁾	Typ.: 3ms Max.: 10ms		
Ambient temperature	-40°C to 125°C		
Shock resistance ⁵⁾⁸⁾	196m/s ²		

- 1) For NO contacts, measured when applying 100% rated voltage on coil.
- 2) Inrush peak current under lamp load, at 13.5VDC.
- 3) 1min, leakage current less than 1mA.
- 4) The value is measured when voltage drops suddenly from nominal voltage to 0 VDC and coil is not paralleled with suppression circuit.
- 5) When energized, opening time of NO contacts shall not exceed 1ms, when non-energized, opening time of NC contacts shall not exceed 1ms, meantime, NO contacts shall not be closed.
- 6) FMVSS: Federal Motor Vehicle Safety Standard.
- 7) Test point is at 2mm away from terminal end, and after removing testing force, the terminal transfiguration shall not exceed 0.5mm.
- 8) Only for the 12VDC coil voltage type.

CONTACT DATA²⁾

Load voltage	Load type		Load current A			On/Off ratio		Electrical endurance OPS	Contact material	Load wiring diagram ¹⁾	Ambient temp.
			1C		1A	On s	Off s				
			NO	NC	NO						
13.5VDC	Resistive	Make	20	10	20	2	2	1×10 ⁵	AgSnO ₂	See diagram 1	See Ambient Temp. Curve
		Break	20	10	20						
	Lamp	Make	100	---	100	2	2	1×10 ⁵	AgSnO ₂	See diagram 2	
		Break	20	---	20						
	Inductive	Make	40	20	40	2	4	1×10 ⁵	AgSnO ₂	See diagram 3	
		Break	20	10	20						
27VDC	Resistive	Make	20	10	20	2	2	1×10 ⁵	AgSnO ₂	See diagram 1	
		Break	20	10	20						



HONGFA RELAY

ISO9001, ISO/TS16949, ISO14001, OHSAS18001, IECQ QC 080000 CERTIFIED

2014 Rev. 1.01

1) The load wiring diagrams are listed below (Ratings of NO, NC are tested based on different samples separately) :

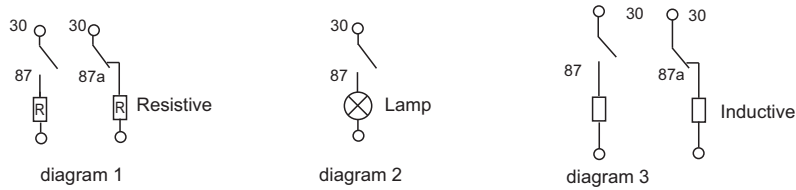

2) Loads mentioned in this chart is for relays with no parallel diode or Zener Diode. For those with parallel diode, Zener Diode or other components, please contact Hongfa for more technical supports.
Please also contact Hongfa if the actual application load is different from what mentioned above.

COIL DATA at 23°C

Nominal voltage VDC	Pick-up voltage VDC max.	Drop-out voltage VDC min.	Coil resistance x(1±10%)Ω	Parallel resistance x(1±5%)Ω	Equivalent resistance Ω	Power consumption W	Max. allowable overdrive voltage ¹⁾ VDC	
							at 23°C	at 85°C
12	7.2	1.2	109	---	---	1.3	20.4	14.9
12	7.2	1.2	109	680	93.9	1.5	20.4	14.9
24	14.4	2.4	360	---	---	1.6	36	28
24	14.4	2.4	360	2700	317.6	1.8	36	28

1) Max. allowable overdrive voltage is stated with no load applied.

ORDERING INFORMATION

Type	HFV9 / 012 -1H S R (XXX)						
Coil voltage	012: 12VDC		024: 24VDC				
Contact arrangement	1H: 1 Form A		1Z: 1 Form C				
Construction	S: Plastic sealed		Nil: Dust protected				
Parallel coil components	R: Parallel transient suppression resistors Nil: Without parallel components						
Customer special code							

OUTLINE DIMENSIONS AND WIRING DIAGRAM Unit: mm

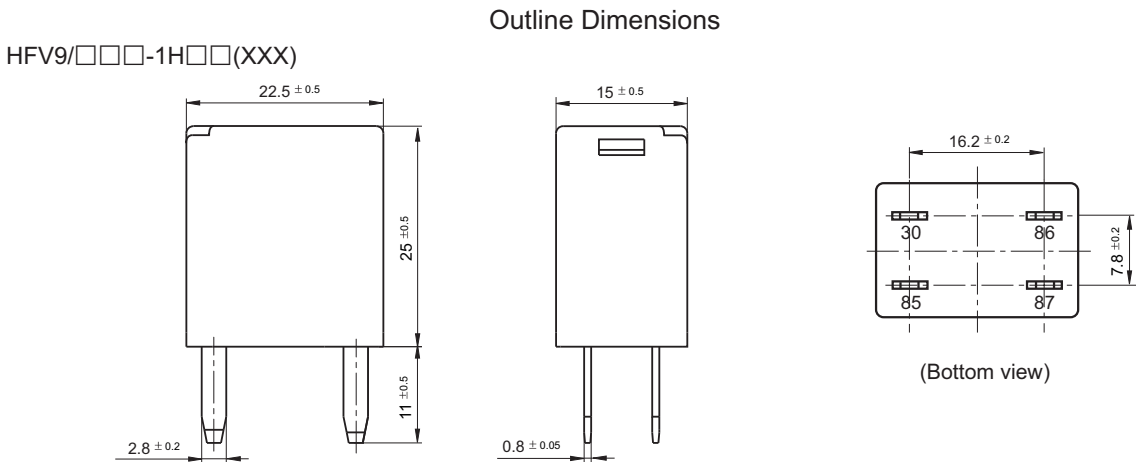

Remark: Terminal vertical deviation tolerance is 0.3mm.

OUTLINE DIMENSIONS, WIRING DIAGRAM AND PC BOARD LAYOUT

Unit: mm

Outline Dimensions

HFV9/□□□-1Z□□(XXX)

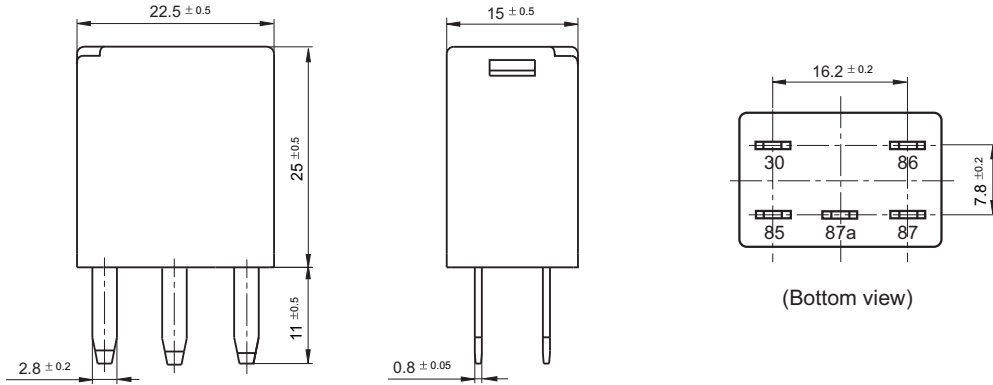

Remark: Terminal vertical deviation tolerance is 0.3mm.

Wiring Diagram

HFV9/□□□-1H□□(XXX)

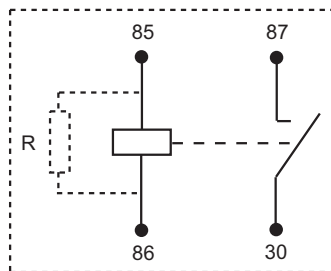

HFV9/□□□-1Z□□(XXX)

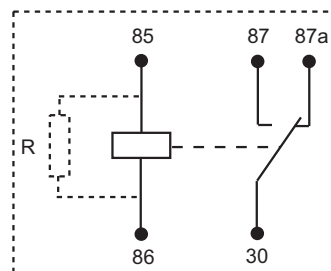

CHARACTERISTIC CURVES

1. Coil operating voltage range

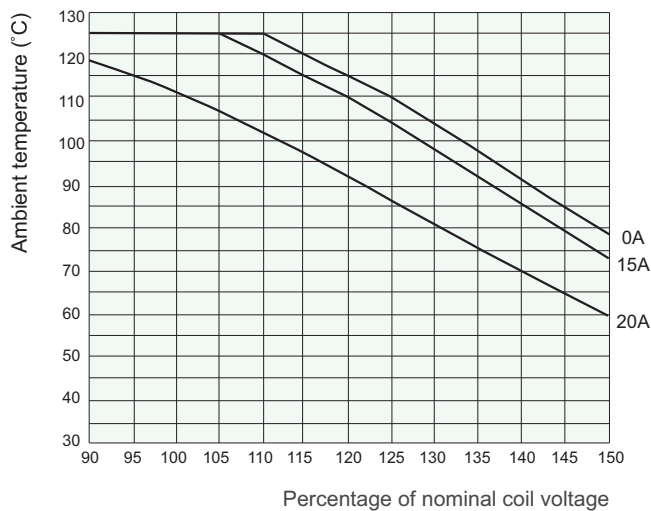

- 1) There should be no contact load applied when maximum continuous operation voltage is applied on coil.
- 2) This chart takes 12VDC coil voltage version as example.
- 3) The maximum allowable coil temperature is 180°C. For the coil temperature rise which is measured by resistance is average value, we recommend the coil temperature should be below 170°C under the different application ambient, different coil voltage and different load etc.
- 4) If the actual operating coil voltage is out of the specified range, please contact Hongfa for further details.

CHARACTERISTIC CURVES

2. Load limit curve (at 23°C)

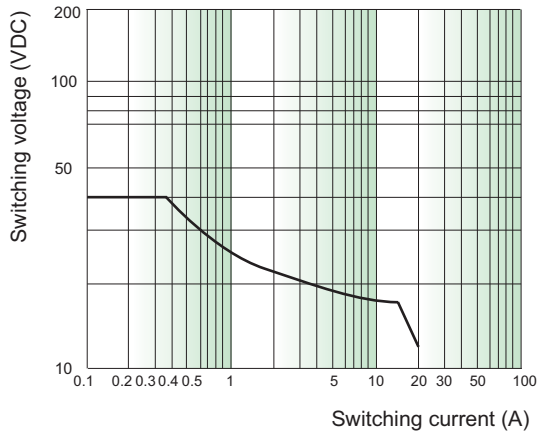

- 1) This chart takes 12VDC, NO contact, resistive load as example.
- 2) The load and electrical endurance tests are made according to "CONTACT DATA" parameters' table. If actual load voltage, current, or operate frequency is different from "CONTACT DATA" table, please arrange corresponding tests for confirmation.

3. Ambient temperature curve of the electrical endurance test

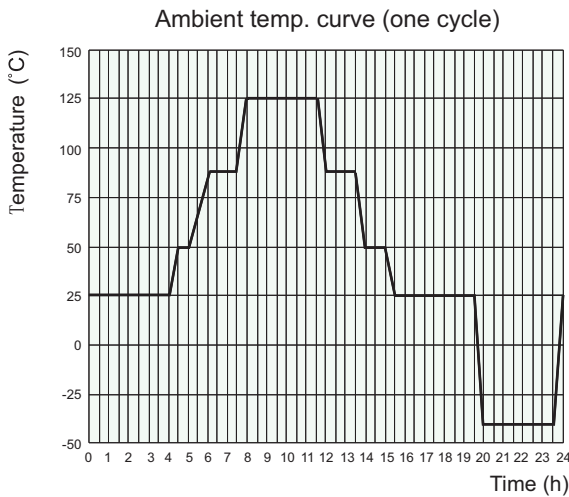

- 1) The minimum temperature is -40°C.
- 2) The maximum temperature is 125°C.

Disclaimer

The specification is for reference only. See to "Terminology and Guidelines" for more information. Specifications subject to change without notice. In case there is specific criterion (such as mission profile, technical specification, PPAP etc.) checked and agreed by and between customer and Hongfa, this specific criterion should be taken as standard regarding any requirement on Hongfa product. We could not evaluate all the performance and all the parameters for every possible application. Thus the user should be in a right position to choose the suitable product for their own application. If there is any query, please contact Hongfa for the technical service. However, it is the user's responsibility to determine which product should be used only.

© Xiamen Hongfa Electroacoustic Co., Ltd. All rights of Hongfa are reserved.