

**SPST-NO Type Breaks 10-A Loads;
SPST-NO + SPST-NC Type
Breaks 8-A Load**

- Compact: 20 x 15 x 10 mm (L x W x H).
- Low power consumption: 200 mW.
- Flux protection or plastic-sealed construction available.
- Unique moving loop armature reduces relay size, magnetic interference, and contact bounce.
- Single- and double-winding latching types also available



Ordering Information

Classification		Straight PCB		Self-clinching PCB	
		Flux protection	Plastic-sealed	Flux protection	Plastic-sealed
Single-side stable	SPST-NO	G6C-1117P-US	G6C-1114P-US	G6C-1117C-US	G6C-1114C-US
	SPST-NO + SPST-NC	G6C-2117P-US	G6C-2114P-US	G6C-2117C-US	G6C-2114C-US
Single-winding latching	SPST-NO	G6CU-1117P-US	G6CU-1114P-US	G6CU-1117C-US	G6CU-1114C-US
	SPST-NO + SPST-NC	G6CU-2117P-US	G6CU-2114P-US	G6CU-2117C-US	G6CU-2114C-US
Double-winding latching	SPST-NO	G6CK-1117P-US	G6CK-1114P-US	G6CK-1117C-US	G6CK-1114C-US
	SPST-NO + SPST-NC	G6CK-2117P-US	G6CK-2114P-US	G6CK-2117C-US	G6CK-2114C-US

Note: When ordering, add the rated coil voltage to the model number.

Example: G6C-1117P-US 12 VDC
_____ Rated coil voltage

Model Number Legend:

G6C - - VDC
1 2 3 4 5 6 7

1. Relay Function

- None: Single-side stable
- U: Single-winding latching
- K: Double-winding latching

2. Contact Form

- 11: SPST-NO
- 21: SPST-NO + SPST-NC

3. Contact Type

- 1: Single button

4. Enclosure Ratings

- 7: Flux protection
- 4: Plastic-sealed

5. Terminals

- P: Straight PCB
- C: Self-clinching PCB

6. Approved Standards

- US: UL/CSA certified

7. Rated Coil Voltage

- 3, 5, 6, 12, 24 VDC

■ Accessories (Order Separately)

Back Connecting Sockets

Applicable relay	Back connecting socket*
G6C(U)-1114P-US G6C(U)-1117P-US G6C(U)-2114P-US G6C(U)-2117P-US	P6C-06P
G6CK-1114P-US G6CK-1117P-US G6CK-2114P-US G6CK-2117P-US	P6C-08P

*Not applicable to the self-clinching versions.

Removal Tool	P6B-Y1
Hold-down Clips	P6B-C2

Specifications

■ Coil Ratings

Single-side Stable Type

Rated voltage	3 VDC	5 VDC	6 VDC	12 VDC	24 VDC
Rated current	67 mA	40 mA	33.3 mA	16.7 mA	8.3 mA
Coil resistance	45 Ω	125 Ω	180 Ω	720 Ω	2,880 Ω
Coil inductance (H) (ref. value)	Armature OFF	0.078	0.22	0.36	1.32
	Armature ON	0.067	0.18	0.29	1.13
Must operate voltage	70% max. of rated voltage				
Must release voltage	10% min. of rated voltage				
Max. voltage	130% of rated voltage				
Power consumption	Approx. 200 mW				

Single-winding Latching Type

Rated voltage	3 VDC	5 VDC	6 VDC	12 VDC	24 VDC
Rated current	67 mA	40 mA	33.3 mA	16.7 mA	8.3 mA
Coil resistance	45 Ω	125 Ω	180 Ω	720 Ω	2,880 Ω
Coil inductance (H) (ref. value)	Armature OFF	0.09	0.25	0.36	1.75
	Armature ON	0.06	0.20	0.24	1.17
Must operate voltage	70% max. of rated voltage				
Must release voltage	70% min. of rated voltage				
Max. voltage	130% of rated voltage				
Power consumption	Approx. 200 mW				

Double-winding Latching Type

Rated voltage		3 VDC	5 VDC	6 VDC	12 VDC	24 VDC	
Set coil	Rated current	93.5 mA	56.0 mA	46.7 mA	23.3 mA	11.7 mA	
	Coil resistance	32.1 Ω	89.3 Ω	129 Ω	514 Ω	2,056 Ω	
	Coil inductance (H) (ref. value)	Armature OFF	0.03	0.07	0.10	0.37	1.56
		Armature ON	0.02	0.06	0.08	0.32	1.18
Reset coil	Rated current	93.5 mA	56.0 mA	46.7 mA	23.3 mA	11.7 mA	
	Coil resistance	32.1 Ω	89.3 Ω	129 Ω	514 Ω	2,056 Ω	
	Coil inductance (H) (ref. value)	Armature OFF	0.03	0.08	0.12	0.47	1.46
		Armature ON	0.02	0.07	0.10	0.38	1.13
Must set voltage		70% max. of rated voltage					
Must reset voltage		70% min. of rated voltage					
Max. voltage		130% of rated voltage					
Power consumption		Set coil: Approx. 280 mW Reset coil: Approx. 280 mW					

- Note:**
1. The rated current and coil resistance are measured at a coil temperature of 23°C with a tolerance of $\pm 10\%$.
 2. Operating characteristics are measured at a coil temperature of 23°C.
 3. The minimum pulse width of the set and reset voltage is 20 ms.

■ Contact Ratings

Item	SPST-NO		SPST-NO+SPST-NC	
	Resistive load ($\cos\phi = 1$)	Inductive load ($\cos\phi = 0.4$; L/R = 7 ms)	Resistive load ($\cos\phi = 1$)	Inductive load ($\cos\phi = 0.4$; L/R = 7 ms)
Rated load	10 A at 250 VAC; 10A at 30 VDC	5 A at 250 VAC; 5 A at 30 VDC	8 A at 250 VAC; 8A at 30 VDC	3.5 A at 250 VAC; 3.5 A at 30 VDC
Contact material	AgCdO			
Rated carry current	10 A		8 A	
Max. switching voltage	380 VAC, 125 VDC (the case of latching 250 VAC, 125 VDC)			
Max. switching current	10 A		8 A	
Max. switching capacity	2,500 VA, 300 W	1,250 VA, 220 W	2,000 VA, 240 W	875 VA, 170 W
Min. permissible load	10 mA at 5 VDC			

■ Characteristics

Contact resistance	30 m Ω max.
Operate (set) time	10 ms max. (mean value: approx. 5 ms)
Release (reset) time	10 ms max. (mean value: approx. 2 ms; latching types: mean value: approx. 5 ms)
Bounce time	Operate: 5 ms max. Release: 5 ms max.
Min. set/reset signal width	Latching type: 20 ms (at 23°C)
Max. switching frequency	Mechanical: 18,000 operations/hr Electrical: 1,800 operations/hr (under rated load)
Insulation resistance	1,000 M Ω min. (at 500 VDC, at 250 VDC between set coil and reset coil)
Dielectric strength	2,000 VAC, 50/60 Hz for 1 min between coil and contacts 2,000 VAC, 50/60 Hz for 1 min between contacts of different polarity 1,000 VAC, 50/60 Hz for 1 min between contacts of same polarity 250 VAC, 50/60 Hz for 1 min between set and reset coils
Impulse withstand voltage	6,000 V, 1.2 x 50 μ s (between coil and contacts) (latching types: 4500 V, 1.2 x 50 μ s)
Vibration resistance	Destruction: 10 to 55 Hz, 1.5-mm double amplitude Malfunction: 10 to 55 Hz, 1.5-mm double amplitude
Shock resistance	Destruction: 1,000 m/s ² (approx. 100G) Malfunction: 100 m/s ² (approx. 10G)
Ambient temperature	Operating: -25°C to 70°C (with no icing) Storage: -25°C to 70°C (with no icing)
Ambient humidity	Operating: 35% to 85%
Life expectancy	Mechanical: 50,000,000 operations min. (at 18,000 operations/hr) Electrical: 100,000 operations min. (at 1,800 operations/hr)
Weight	Approx. 5.6 g

■ Approved Standards

UL508 (File No. E41643)

Model	Contact form	Coil rating	Contact rating
G6C-1114P-US G6C-1114C-US G6C-1117P-US G6C-1117C-US	SPST-NO	3 to 60 VDC	10 A, 250 VAC (general use) 10 A, 30 VDC (resistive load) 1/6 hp, 125 VAC 1/4 hp, 125 VAC 1/4 hp, 250 VAC 1/3 hp, 250 VAC TV-5 600 W, 120 VAC (tungsten) 530 VA, 20 to 265 VAC, 2 A max. (pilot duty) 43.2 VA, 30 VDC (pilot duty) 12LRA, 2.2FLA, 30 VDC (30,000 cycle)
G6C-2114P-US G6C-2114C-US G6C-2117P-US G6C-2117C-US	SPST-NO + SPST-NC		8 A, 250 VAC (general use) 8 A, 30 VDC (resistive load) 1/6 hp, 125 VAC 1/4 hp, 125 VAC 1/4 hp, 250 VAC TV-5 600 W, 120 VAC (tungsten) 530 VA, 20 to 265 VAC, 2 A max. (pilot duty) 43.2 VA, 30 VDC (pilot duty) 12LRA, 2.2FLA, 30 VDC (30,000 cycle)

CSA C22.2 No.14 (File No. LR31928)

Model	Contact form	Coil rating	Contact rating
G6C-1114P-US G6C-1114C-US G6C-1117P-US G6C-1117C-US	SPST-NO	3 to 60 VDC	10 A, 250 VAC (general use) 10 A, 30 VDC (resistive load) 1/6 hp, 125 VAC 1/4 hp, 125 VAC 1/4 hp, 250 VAC 1/3 hp, 250 VAC TV-5 600 W, 120 VAC (tungsten)
G6C-2114P-US G6C-2114C-US G6C-2117P-US G6C-2117C-US	SPST-NO + SPST-NC	3 to 60 VDC	8 A, 250 VAC (general use) 8 A, 30 VDC (resistive load) 1/6 hp, 125 VAC 1/4 hp, 125 VAC 1/4 hp, 250 VAC TV-5 600 W, 120 VAC (tungsten)

Engineering Data

Max. Switching Capacity

SPST-NO

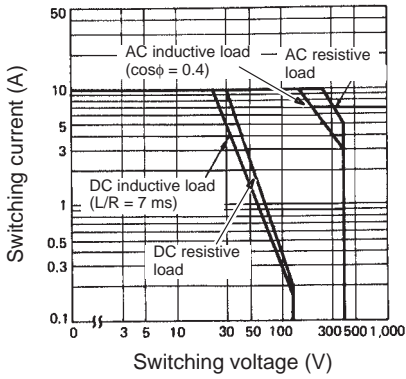

SPST-NO + SPST-NC

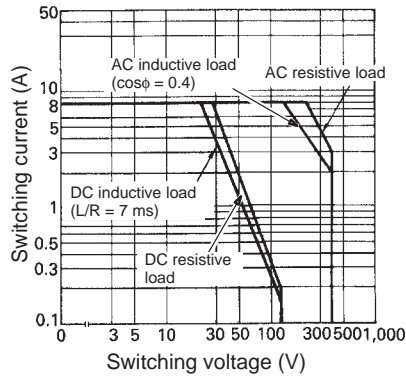

Life Expectancy

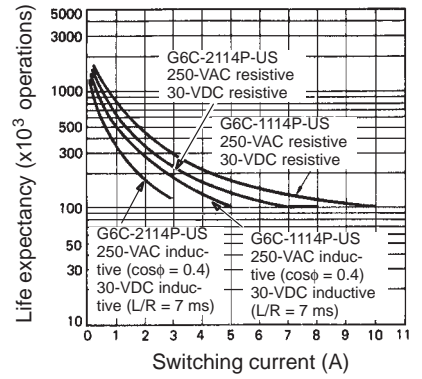

Ambient Temperature vs. Maximum Voltage

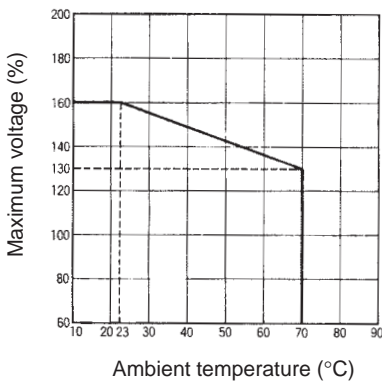

Dimensions

Note: 1. All units are in millimeters unless otherwise indicated.

2. Orientation mark is indicated as follows: 

G6C-□117P-US

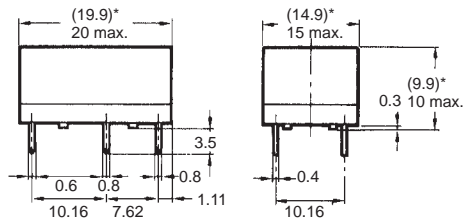
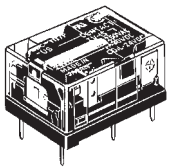

*Average value

G6C-1117P-US, G6C-1117C-US G6C-1114P-US, G6C-1114C-US Terminal Arrangement/Internal Connections (Bottom View)

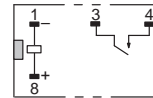

Mounting Holes (Bottom View)

Tolerance: ±0.1

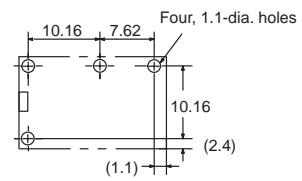

G6C-□117C-US

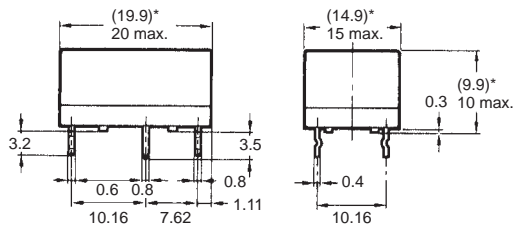
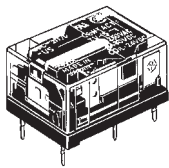

*Average value

G6C-□114P-US

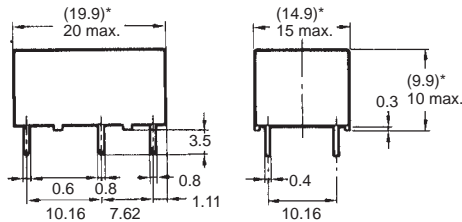
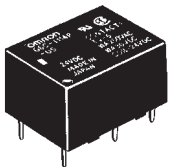

*Average value

G6C-2117P-US, G6C-2117C-US G6C-2114P-US, G6C-2114C-US Terminal Arrangement/Internal Connections (Bottom View)

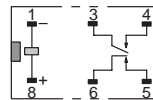

Mounting Holes (Bottom View)

Tolerance: ±0.1

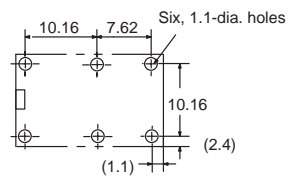

G6C-□114C-US

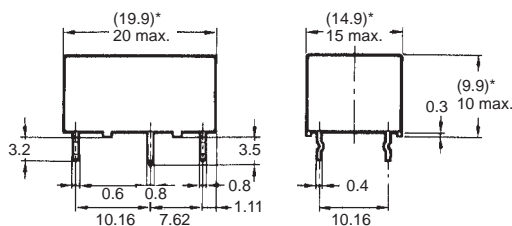
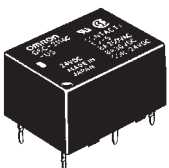

*Average value

G6CU-□117P-US

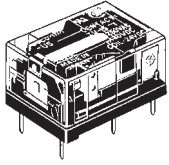

*Average value

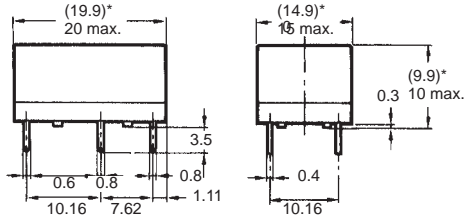

G6CU-117P-US, G6CU-117C-US
G6CU-1114P-US, G6CU-1114C-US
Terminal Arrangement/Internal Connections (Bottom View)

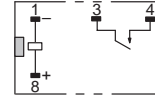

Mounting Holes (Bottom View)

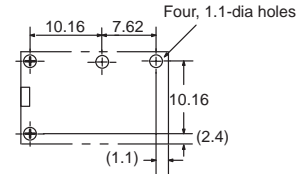

G6CU-□117C-US

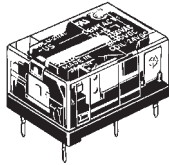

*Average value

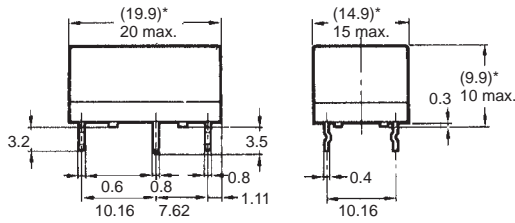

G6CU-2117P-US, G6CU-2117C-US
G6CU-2114P-US, G6CU-2114C-US
Terminal Arrangement/Internal Connections (Bottom View)

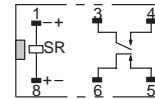

Mounting Holes (Bottom View)

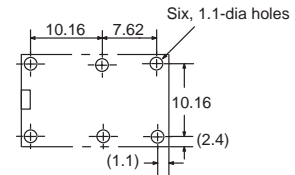

G6CU-□114P-US

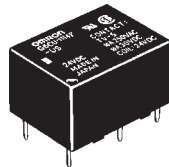

*Average value

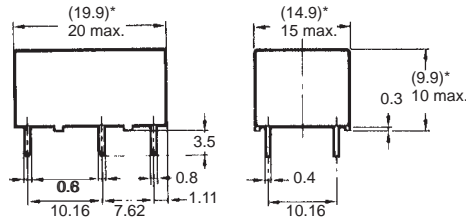

G6CU-□114C-US

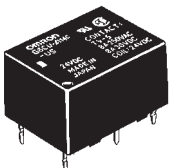

*Average value

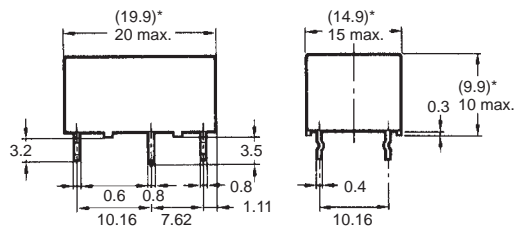

G6CK-□117P-US

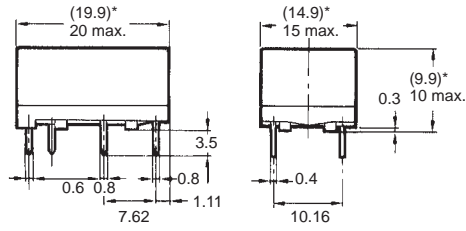
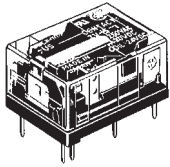

*Average value

G6CK-117P-US, G6CK-117C-US
G6CK-1114P-US, G6CK-1114C-US

Terminal Arrangement/Internal Connections (Bottom View)

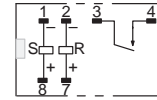

Mounting Holes (Bottom View)

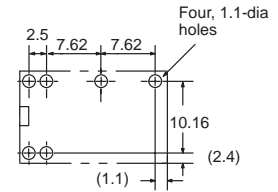

G6CK-□117C-US

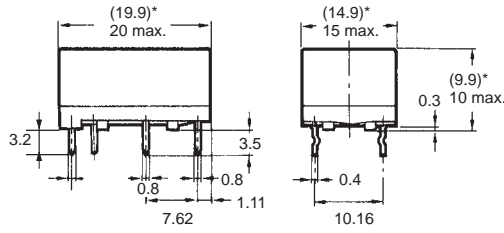
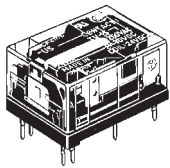

*Average value

G6CK-□114P-US

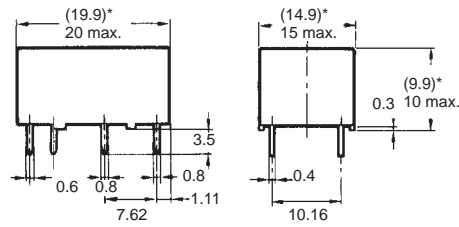
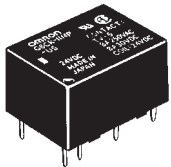

*Average value

G6CK-2117P-US, G6CK-2117C-US
G6CK-2114P-US, G6CK-2114C-US

Terminal Arrangement/Internal Connections (Bottom View)

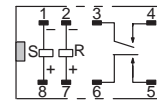

Mounting Holes (Bottom View)

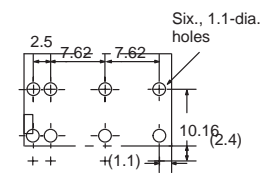

G6CK-□114C-US

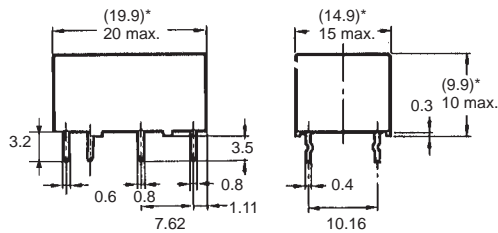
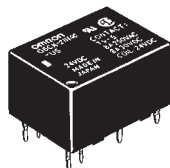

*Average value

Back Connecting Sockets

P6C-06P

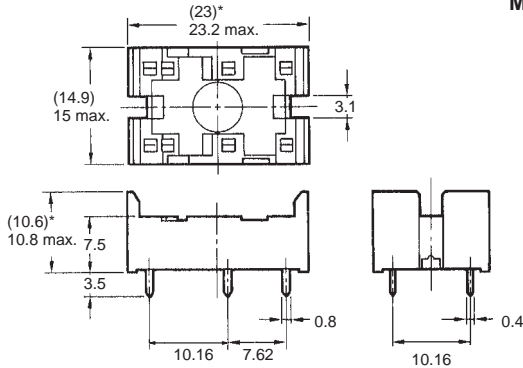
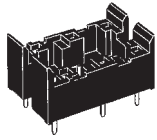

*Average value

Mounting Holes (Bottom View)

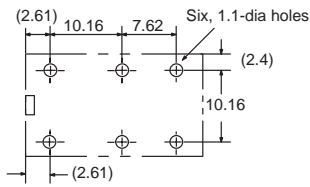

Mounting Height of Relay with Connecting Socket

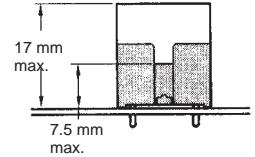

P6C-08P

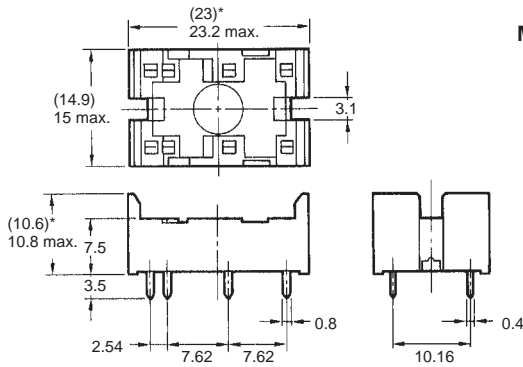
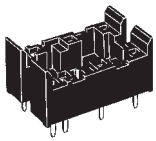

*Average value

Mounting Holes (Bottom View)

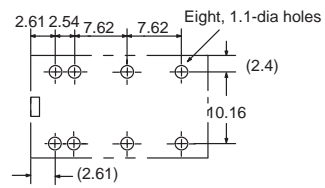

Note: Rated current of socket max. 5 A

Removal Tool

P6B-Y1

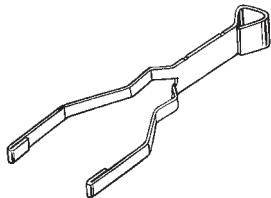

Hold-down Clips

P6B-C2

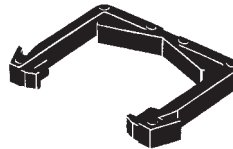

ALL DIMENSIONS SHOWN ARE IN MILLIMETERS.

To convert millimeters into inches, multiply by 0.03937. To convert grams into ounces, multiply by 0.03527.