

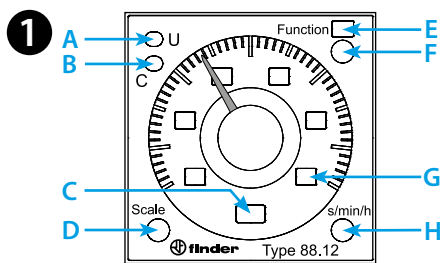





88.12



	<b>88.12.0.230.0002</b> U <sub>N</sub> (24...230)V AC (50/60 Hz) / DC U <sub>min</sub> 20.4 V AC / DC U <sub>max</sub> 264.5 V AC / DC P 2.5 VA (230 V) / 1.5 W (24 V)
	2 CO (DPDT) 8 A 250 V AC  AC1 2000 VA AC15 (230 V AC) 400 VA M (230 V AC) 0.3 kW DC1 (30/110/220)V (8/0.3/0.12)A
	(-10...+55)°C
IP40	

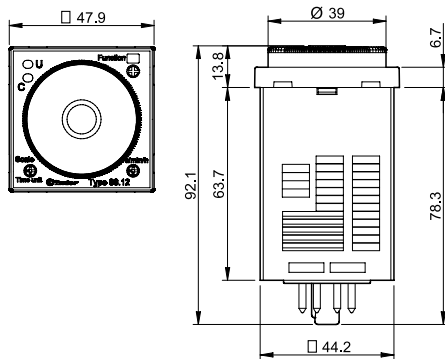







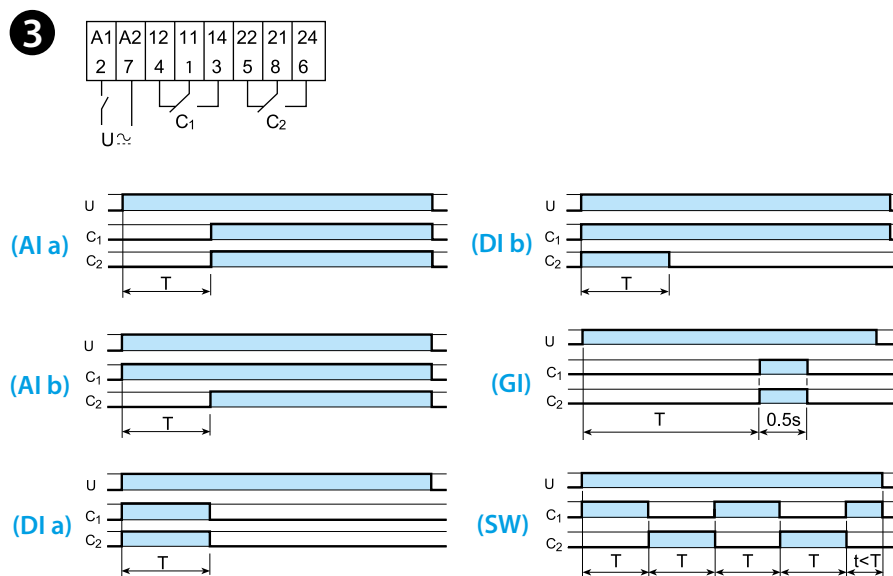



Utility Model - IB8812001 - 01/21  
Finder S.p.A. con unico socio - 10040 ALMESE (TO) - ITALY

**2**

D \ H	sec	min	h	hx10
0.5	0.5 s	0.5 min	0.5 h	5 h
1	1 s	1 min	1 h	10 h
5	5 s	5 min	5 h	50 h
10	10 s	10 min	10 h	100 h



LED A (U <sub>N</sub> )	LED B (M)	U <sub>N</sub>		
		-	x1 - x4	x1 - x2
		✓	x1 - x4 x1 - x2	x1 - x2 x1 - x4
		✓	 x1 - x4	x1 - x2
		✓	x1 - x2	x1 - x4

# ENGLISH

## 88.12 PLUG-IN TIMERS

- 1 FRONT VIEW**
- A Yellow LED: power ON (U)
  - B Red LED: timing in progress (C)
  - C Unit of time selected
  - D Time scale selector
  - E Function selected
  - F Function selector: Ala - Alb - Dla - Dib - GI - SW
  - G Time selected: 0.5 - 1 - 5 - 10
  - H Unit of time selector: sec(second), min (minute), h (hour), hx10(10 hour)

- 2 FULL SCALE VALUE FOR TYPE 88.12**
- D Time scale selector : 0.5 - 1 - 5 - 10
  - H Unit of time selector: sec(second), min (minute), h (hour), hx10(10 hour)

- 3 WIRING DIAGRAM AND FUNCTIONS**  
**Without control signal**
- Ala On-delay (2 timed contacts)
  - Alb On-delay (1 timed + 1 instantaneous contact)
  - Dla Interval (2 timed contacts)
  - Dlb Interval (1 timed + 1 instantaneous contact)
  - GI Pulse delayed
  - SW Symmetrical flasher (starting pulse on)

**NOTE**  
Time scales and functions must be set before energising the timer.  
Recovery time: 200 ms.