

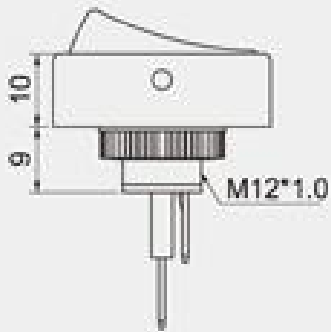





R13-207



Ø 12.2
4 mm max



20A 12V DC
10A 24V DC
6A 14V

FUNCTION		TERMINAL
A  OFF ON 2P SPST	C  ON ON 3P SPDT	0 1  .250" SQ
B  OFF ON 3P SPST (NEON)	L  OFF ON 3P SPST (LED)	
B 2  OFF ON 3P SPST (NEON)	