

# LIGHT

## IP65 JUNCTION BOXES

Description: IP65 WATERTIGHT JUNCTION BOX WITH CONICAL CABLE GLANDS

Reference:

**EV231**

### Characteristics:

<b>Product type:</b>	Watertight junction boxes with opaque cover and conical cable glands
<b>Exterior dimensions (Height x Width x Depth):</b>	197x260x100 mm
<b>Dimensions of the flush-fit gap (HxWxD):</b>	-
<b>Number of modules:</b>	-
<b>Installation:</b>	Surface
<b>Color:</b>	RAL 7035
<b>Window:</b>	White
<b>Weight (kg):</b>	0,54
<b>Cable entry:</b>	4xM25 - 6xM40
<b>Components:</b>	-
<b>Materials:</b>	Halogen-free plastic materials. Base: Shock-proof PS. Conical cable glands: PVC
<b>Lid-window-door material:</b>	Shock-proof PS

### Technical data:

<b>Degree of protection:</b>	IP65
<b>Resistance to impact:</b>	IK07
<b>Glow wire resistance:</b>	650 °C
<b>Ball pressure test:</b>	70 °C
<b>Ambient temperature range:</b>	-25 °C / +40 °C
<b>Maximum operating voltage:</b>	1000 V AC / 1500 V DC
<b>Rated current:</b>	
<b>Double insulation:</b>	Class II

### Certificates and standards:

<b>Directive:</b>	2014/35/EU
<b>Standards:</b>	IEC 60670-22
<b>Certificates:</b>	



### Codes:

<b>EAN:</b>	8431044192000
<b>Customs tariff number:</b>	85.38.10.00
<b>ETIM 8.0:</b>	EC002600

# LIGHT

## IP65 JUNCTION BOXES

Description: IP65 WATERTIGHT JUNCTION BOX WITH CONICAL CABLE GLANDS

Reference: EV231

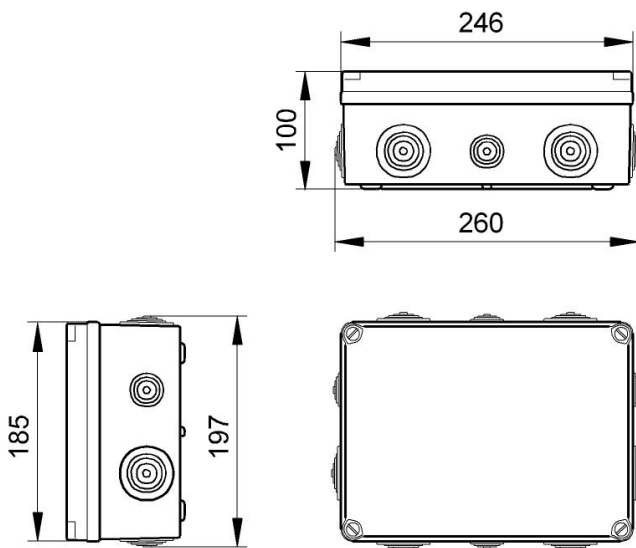

### Detailed drawing:

 <http://www.ide.es/downloads/planos/pdf/EV231.pdf>

 <http://www.ide.es/downloads/planos/dxf/EV231.dxf>

 <http://www.ide.es/downloads/planos/stp/EV231.stp>

### Exterior dimensions (Height x Width x Depth):

197x260x100 mm

### Dimensions of the flush-fit gap (Height x Width x Depth):

-

### Sustainability:

RoHS - REACH

### Supply:

The boxes are supplied individually, shrink-wrapped and in multiple cardboard packaging, according to minimum packaging units. Boxes with conical cable glands are supplied with the cone assembled.

**Packaging units:** 16

### Product end of life:

It does not require specific recycling operations.

### Recommended applications:

Industrial and outdoor environments. Industrial sites, docks, swimming pools, garages, anywhere that requires a high degree of protection against dust, splashes and impacts.