

Metallized Polyester film capacitors

PCMT 369

MKT RADIAL LACQUERED CAPACITORS (Dipped Type) - BROWN

Pitch 10.0/15.0/20.0/22.5/27.5 mm (reduced pitch ; 7.5mm)

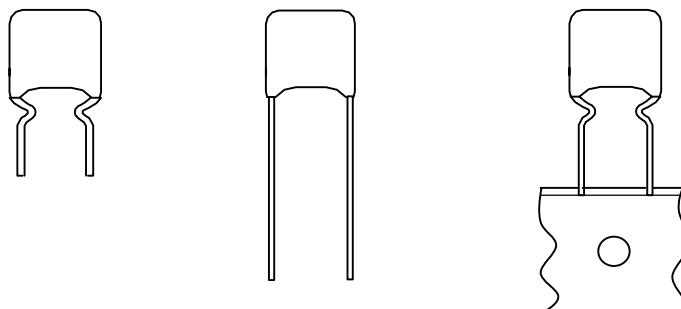

QUICK REFERENCE DATA

Capacitance range (E12 series)	0.01 to 10 μ F
Capacitance tolerance	$\pm 5\%$, $\pm 10\%$
Rated voltage V_{Rdc}	100 V, 250 V, 400 V, 630 V
Climatic category	55/105/56
Temperature range	-55 $^{\circ}$ C ~ +105 $^{\circ}$ C
Reference specification	IEC 60384-2
Coating material	Qualified in accordance with UL94V-0

FEATURES	APPLICATIONS
<ul style="list-style-type: none"> . Low inductive wound cell of Metallized (PETP) film . Cell protected by epoxy lacquer . Radial leads of solder coated wire . Withstand solvents and rinsing liquids 	<ul style="list-style-type: none"> . Blocking and coupling . Bypass and energy reservoir application

- Please refer to caution and warning at <http://www.pilkor.co.kr/download/Introductions.pdf> before using these products.

Metallized Polyester film capacitors

PCMT 369

 $V_{Rdc} = 100 \text{ V}$ $V_{Rac} = 63 \text{ V}$

Cap (μF)	$W_{\max} \times H_{\max} \times T_{\max}$ (mm)	mass (g)	CATALOGUE NUMBER	
			PCMT 369	
			loose in box	
			It = 4.5 \pm 0.5 mm	
			C-tol. \pm 5 %	C-tol. \pm 10 %
Pitch = 10.0 \pm 0.4 mm			$d_t = 0.6 \text{ mm } +0.06 / -0.05$	
0.39	12.5 x 10.5 x 5.0	0.5	PCMT 369D24394	PCMT 369D23394
0.47	12.5 x 11.0 x 5.5	0.6	PCMT 369D24474	PCMT 369D23474
0.56	12.5 x 11.5 x 6.0	0.7	PCMT 369D24564	PCMT 369D23564
0.68	12.5 x 12.0 x 6.5	0.8	PCMT 369D24684	PCMT 369D23684
0.82	12.5 x 12.0 x 6.5	0.8	PCMT 369D24824	PCMT 369D23824
1.0	12.5 x 12.0 x 6.5	0.8	PCMT 369D24105	PCMT 369D23105
Pitch = 15.0 \pm 0.4 mm			$d_t = 0.6 \text{ mm } +0.06 / -0.05$	
0.82	18.0 x 11.0 x 5.5	0.9	PCMT 369F24824	PCMT 369F23824
1.0	18.0 x 11.5 x 6.0	1.1	PCMT 369F24105	PCMT 369F23105
1.2	18.0 x 12.0 x 6.5	1.3	PCMT 369F24125	PCMT 369F23125
1.5	18.0 x 12.5 x 7.5	1.6	PCMT 369F24155	PCMT 369F23155
Pitch = 15.0 \pm 0.4 mm			$d_t = 0.8 \text{ mm } +0.08 / -0.05$	
1.8	18.0 x 13.5 x 8.0	1.9	PCMT 369F24185	PCMT 369F23185
2.2	18.0 x 14.5 x 9.0	2.2	PCMT 369F24225	PCMT 369F23225
Pitch = 22.5 \pm 0.4 mm			$d_t = 0.8 \text{ mm } +0.08 / -0.05$	
2.7	26.0 x 15.5 x 6.5	2.6	PCMT 369J24275	PCMT 369J23275
3.3	26.0 x 16.0 x 7.5	3.0	PCMT 369J24335	PCMT 369J23335
3.9	26.0 x 17.0 x 8.0	3.5	PCMT 369J24395	PCMT 369J23395
4.7	26.0 x 17.5 x 9.0	4.0	PCMT 369J24475	PCMT 369J23475
5.6	26.0 x 18.5 x 10.0	4.6	PCMT 369J24565	PCMT 369J23565
6.8	26.0 x 20.0 x 11.0	5.2	PCMT 369J24685	PCMT 369J23685

Metallized Polyester film capacitors

PCMT 369

 $V_{Rdc} = 250 V$ $V_{Rac} = 160 V$

mini type

Cap. (μF)	$W_{max} \times H_{max} \times T_{max}$ (mm)	Mass (g)	CATALOGUE NUMBER	
			PCMT 369	
			loose in box	
			It = 4.5 \pm 0.5 mm	
		C-tol. \pm 5 %	C-tol. \pm 10 %	
Pitch = 10.0 \pm 0.4 mm			$d_t = 0.6 \text{ mm } +0.06 / -0.05$	
0.10	12.5 x 9.5 x 4.5		PCMT 369DA4104	PCMT 369DA3104
0.12	12.5 x 10.0 x 4.5		PCMT 369DA4124	PCMT 369DA3124
0.15	12.5 x 10.0 x 4.5		PCMT 369DA4154	PCMT 369DA3154
0.18	12.5 x 10.0 x 5.0		PCMT 369DA4184	PCMT 369DA3184
0.22	12.5 x 10.5 x 5.5		PCMT 369DA4224	PCMT 369DA3224
0.27	12.5 x 11.0 x 6.0		PCMT 369DA4274	PCMT 369DA3274
0.33	12.5 x 11.5 x 6.5		PCMT 369DA4334	PCMT 369DA3334
0.39	12.5 x 12.0 x 7.0		PCMT 369DA4394	PCMT 369DA3394
0.47	12.5 x 13.0 x 8.0		PCMT 369DA4474	PCMT 369DA3474
Pitch = 15.0 \pm 0.4 mm			$d_t = 0.6 \text{ mm } +0.06 / -0.05$	
0.47	18.0 x 11.0 x 6.0		PCMT 369FA4474	PCMT 369FA3474
0.56	18.0 x 11.5 x 6.5		PCMT 369FA4564	PCMT 369FA3564
0.68	18.0 x 12.0 x 7.0		PCMT 369FA4684	PCMT 369FA3684
Pitch = 15.0 \pm 0.4 mm			$d_t = 0.8 \text{ mm } +0.08 / -0.05$	
0.82	18.0 x 12.5 x 7.5		PCMT 369FA4824	PCMT 369FA3824
1.0	18.0 x 14.0 x 8.0		PCMT 369FA4105	PCMT 369FA3105
1.2	18.0 x 14.5 x 9.0		PCMT 369FA4125	PCMT 369FA3125
1.5	18.0 x 15.5 x 10.0		PCMT 369FA4155	PCMT 369FA3155
Pitch = 22.5 \pm 0.4 mm			$d_t = 0.8 \text{ mm } +0.08 / -0.05$	
1.8	26.0 x 16.0 x 7.0		PCMT 369JA4185	PCMT 369JA3185
2.2	26.0 x 17.0 x 8.0		PCMT 369JA4225	PCMT 369JA3225
2.7	26.0 x 17.5 x 9.0		PCMT 369JA4275	PCMT 369JA3275
3.3	26.0 x 18.5 x 10.0		PCMT 369JA4335	PCMT 369JA3335
3.9	26.0 x 20.0 x 11.0		PCMT 369JA4395	PCMT 369JA3395
4.7	26.0 x 21.5 x 12.0		PCMT 369JA4475	PCMT 369JA3475
5.6	26.0 x 22.5 x 13.0		PCMT 369JA4565	PCMT 369JA3565
6.6	26.0 x 23.5 x 14.5		PCMT 369JA4665	PCMT 369JA3665
6.8	26.0 x 24.5 x 15.0		PCMT 369JA4685	PCMT 369JA3685
Pitch = 27.5 \pm 0.4 mm			$d_t = 0.8 \text{ mm } +0.08 / -0.05$	
6.8	31.0 x 22.5 x 13.0		PCMT 369LA4685	PCMT 369LA3685

Metallized Polyester film capacitors

PCMT 369

 $V_{Rdc} = 400\text{ V}$ $V_{Rac} = 220\text{ V}$

mini type

Cap. (μF)	$W_{\max} \times H_{\max} \times T_{\max}$ (mm)	Mass (g)	CATALOGUE NUMBER	
			PCMT 369	
			loose in box	
			It = 4.5 \pm 0.5 mm	
		C-tol. \pm 5 %	C-tol. \pm 10 %	
Pitch = 10.0 \pm 0.4 mm		$d_t = 0.6\text{ mm} +0.06 / -0.05$		
0.047	12.5 x 9.5 x 4.5		PCMT 369DB4473	PCMT 369DB3473
0.056	12.5 x 10.0 x 4.5		PCMT 369DB4563	PCMT 369DB3563
0.068	12.5 x 10.0 x 5.0		PCMT 369DB4683	PCMT 369DB3683
0.082	12.5 x 10.5 x 5.5		PCMT 369DB4823	PCMT 369DB3823
0.10	12.5 x 11.0 x 5.5		PCMT 369DB4104	PCMT 369DB3104
0.12	12.5 x 11.5 x 6.0		PCMT 369DB4124	PCMT 369DB3124
0.15	12.5 x 12.0 x 6.5		PCMT 369DB4154	PCMT 369DB3154
0.18	12.5 x 12.0 x 7.5		PCMT 369DB4184	PCMT 369DB3184
0.22	12.5 x 13.0 x 8.5		PCMT 369DB4224	PCMT 369DB3224
Pitch = 15.0 \pm 0.4 mm		$d_t = 0.6\text{ mm} +0.06 / -0.05$		
0.22	18.0 x 11.0 x 6.0		PCMT 369FB4224	PCMT 369FB3224
0.27	18.0 x 11.5 x 6.5		PCMT 369FB4274	PCMT 369FB3274
0.33	18.0 x 12.5 x 7.0		PCMT 369FB4334	PCMT 369FB3334
Pitch = 15.0 \pm 0.4 mm		$d_t = 0.8\text{ mm} +0.08 / -0.05$		
0.39	18.0 x 13.0 x 8.0		PCMT 369FB4394	PCMT 369FB3394
0.47	18.0 x 14.0 x 8.5		PCMT 369FB4474	PCMT 369FB3474
0.56	18.0 x 15.0 x 9.5		PCMT 369FB4564	PCMT 369FB3564
0.68	18.0 x 15.5 x 10.5		PCMT 369FB4684	PCMT 369FB3684
0.82	18.0 x 16.5 x 11.5		PCMT 369FB4824	PCMT 369FB3824
1.0	18.0 x 18.5 x 11.5		PCMT 369FB4105	PCMT 369FB3105
Pitch = 22.5 \pm 0.4 mm		$d_t = 0.8\text{ mm} +0.08 / -0.05$		
1.0	26.0 x 17.0 x 8.0		PCMT 369JB4105	PCMT 369JB3105
1.2	26.0 x 17.5 x 9.5		PCMT 369JB4125	PCMT 369JB3125
1.5	26.0 x 19.0 x 10.5		PCMT 369JB4155	PCMT 369JB3155
1.8	26.0 x 20.5 x 11.5		PCMT 369JB4185	PCMT 369JB3185
2.2	26.0 x 21.5 x 13.5		PCMT 369JB4225	PCMT 369JB3225
2.7	26.0 x 23.0 x 14.5		PCMT 369JB4275	PCMT 369JB3275
3.3	26.0 x 25.0 x 16.0		PCMT 369JB4335	PCMT 369JB3335
Pitch = 27.5 \pm 0.4 mm		$d_t = 0.8\text{ mm} +0.08 / -0.05$		
3.3	31.0 x 23.5 x 14.5		PCMT 369LB4335	PCMT 369LB3335
3.9	31.0 x 25.5 x 15.5		PCMT 369LB4395	PCMT 369LB3395
4.7	31.0 x 27.0 x 17.0		PCMT 369LB4475	PCMT 369LB3475

Metallized Polyester film capacitors

PCMT 369

 $V_{Rdc} = 630 \text{ V}$ $V_{Rac} = 250 \text{ V}$

mini type

Cap. (μF)	$W_{\text{max}} \times H_{\text{max}} \times T_{\text{max}}$ (mm)	Mass (g)	CATALOGUE NUMBER	
			PCMT 369	
			loose in box	
			It = 4.5 \pm 0.5 mm	
			C-tol. \pm 5 %	C-tol. \pm 10 %
Pitch = 10.0 \pm 0.4 mm			$d_t = 0.6 \text{ mm } +0.06 / -0.05$	
0.010	12.5 x 9.5 x 4.5		PCMT 369DC4103	PCMT 369DC3103
0.012	12.5 x 10.0 x 4.5		PCMT 369DC4123	PCMT 369DC3123
0.015	12.5 x 10.0 x 4.5		PCMT 369DC4153	PCMT 369DC3153
0.018	12.5 x 10.0 x 4.5		PCMT 369DC4183	PCMT 369DC3183
0.022	12.5 x 10.0 x 4.5		PCMT 369DC4223	PCMT 369DC3223
0.027	12.5 x 10.0 x 5.0		PCMT 369DC4273	PCMT 369DC3273
0.033	12.5 x 10.5 x 5.5		PCMT 369DC4333	PCMT 369DC3333
0.039	12.5 x 10.5 x 5.5		PCMT 369DC4393	PCMT 369DC3393
0.047	12.5 x 11.0 x 6.0		PCMT 369DC4473	PCMT 369DC3473
0.056	12.5 x 11.5 x 6.5		PCMT 369DC4563	PCMT 369DC3563
0.068	12.5 x 12.0 x 7.0		PCMT 369DC4683	PCMT 369DC3683
0.082	12.5 x 12.5 x 7.5		PCMT 369DC4823	PCMT 369DC3823
0.10	12.5 x 13.5 x 8.5		PCMT 369DC4104	PCMT 369DC3104
Pitch = 15.0 \pm 0.4 mm			$d_t = 0.6 \text{ mm } +0.06 / -0.05$	
0.10	18.0 x 11.5 x 6.5		PCMT 369FC4104	PCMT 369FC3104
0.12	18.0 x 12.0 x 7.0		PCMT 369FC4124	PCMT 369FC3124
0.15	18.0 x 12.5 x 7.5		PCMT 369FC4154	PCMT 369FC3154
Pitch = 15.0 \pm 0.4 mm			$d_t = 0.8 \text{ mm } +0.08 / -0.05$	
0.18	18.0 x 13.5 x 8.5		PCMT 369FC4184	PCMT 369FC3184
0.22	18.0 x 14.5 x 9.0		PCMT 369FC4224	PCMT 369FC3224
0.27	18.0 x 15.5 x 9.0		PCMT 369FC4274	PCMT 369FC3274
0.33	18.0 x 16.5 x 10.0		PCMT 369FC4334	PCMT 369FC3334
0.39	18.0 x 17.5 x 11.0		PCMT 369FC4394	PCMT 369FC3394
Pitch = 22.5 \pm 0.4 mm			$d_t = 0.8 \text{ mm } +0.08 / -0.05$	
0.47	26.0 x 17.5 x 8.5		PCMT 369JC4474	PCMT 369JC3474
0.56	26.0 x 18.5 x 10.0		PCMT 369JC4564	PCMT 369JC3564
0.68	26.0 x 20.0 x 11.0		PCMT 369JC4684	PCMT 369JC3684
0.82	26.0 x 21.0 x 12.0		PCMT 369JC4824	PCMT 369JC3824
1.0	26.0 x 22.5 x 13.5		PCMT 369JC4105	PCMT 369JC3105

MOUNTING

Normal use

The capacitors are designed for mounting on printed-wiring boards. The capacitors packed in bandoliers are designed for mounting on printed-wiring boards by means of automatic insertion machines.

For detailed specifications refer to chapter packing.

Specified method of mounting to withstand vibration and shock

In order to withstand vibration and shock tests, it must be ensured that the underside of the crimps are in good contact with the printed-wiring board.

- For pitches of 15 mm the capacitors shall be mechanically fixed by the leads.
- For larger pitches the capacitors shall be mounted in the same way and the body clamped.

RATINGS AND CHARACTERISTICS

Unless otherwise specified, all electrical values apply to an ambient free air temperature of $23 \pm 1^\circ\text{C}$, an atmospheric pressure of 86 to 106 kPa and a relative humidity of $50 \pm 2\%$.

For reference testing, a conditioning period shall be applied over 96 ± 4 hours by heating the products in a circulating air oven at the rated temperature and a relative humidity not exceeding 20%.

CHARACTERISTICS

• Dissipation Factor

Rated voltage	Capacitance	Tangent of loss angle ($\times 10^{-4}$)	
		1 KHz	10 KHz
100V	$0.39\mu\text{F} < C \leq 0.47\mu\text{F}$	≤ 75	≤ 120
	$0.47\mu\text{F} < C \leq 6.8\mu\text{F}$	≤ 75	≤ 120
250V	$0.1\mu\text{F} < C \leq 0.47\mu\text{F}$	≤ 75	≤ 120
	$0.47\mu\text{F} < C \leq 6.8\mu\text{F}$	≤ 75	≤ 120
400V / 630V	$C \leq 0.1\mu\text{F}$	≤ 75	≤ 120
	$0.1\mu\text{F} < C \leq 0.47\mu\text{F}$	≤ 75	≤ 120
	$C > 0.47\mu\text{F}$	≤ 75	≤ 120

• Insulation Resistance

The insulation resistance is measured after a voltage has been applied for 1 minute ± 5 seconds, the voltage being $100 \pm 15\text{V}$ for the 100, 250 and 400 V versions and $500 \pm 50\text{V}$ for the 630 V versions.

Rated voltage	Capacitance	R between leads ($\text{M}\Omega$)	RC between leads (sec)
100V	$C > 0.33\mu\text{F}$	-	$> 5000\text{s}$
250V/ 400V/ 630V	$C \leq 0.33\mu\text{F}$	> 30000	-
	$C > 0.33\mu\text{F}$	-	$> 10000\text{s}$

• Rated Voltage Pulse Load Slope (dV/dt)_R

The maximum pulse load are value valid for pulse voltage equal to the rated voltage. For lower voltages the given values may be multiplied by V_{Rdc} and divided by the applied voltage.

Rated voltage	Rated pulse load(V/ μs) as a function of I_{max}			
	$I_{\text{max}} = 12.5\text{mm}$	$I_{\text{max}} = 18.0\text{mm}$	$I_{\text{max}} = 26.0\text{mm}$	$I_{\text{max}} = 31.0\text{mm}$
100V	30	20	20	-
250V	120	45	20	15
400V	170	65	30	25
630V	90	90	35	30

THE GRAPHS OF CHARACTERISTICS

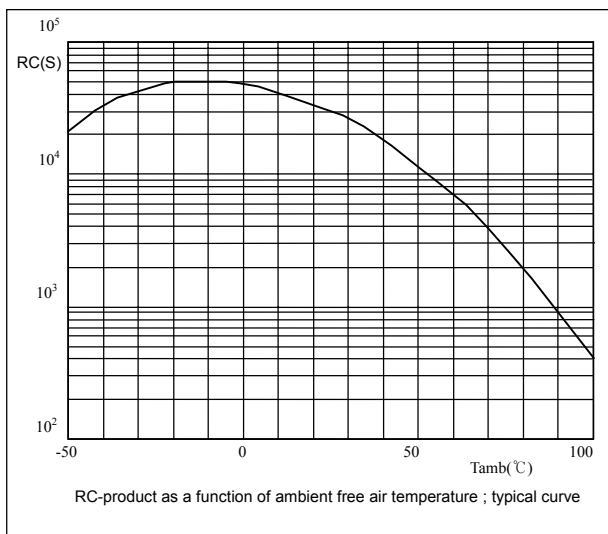
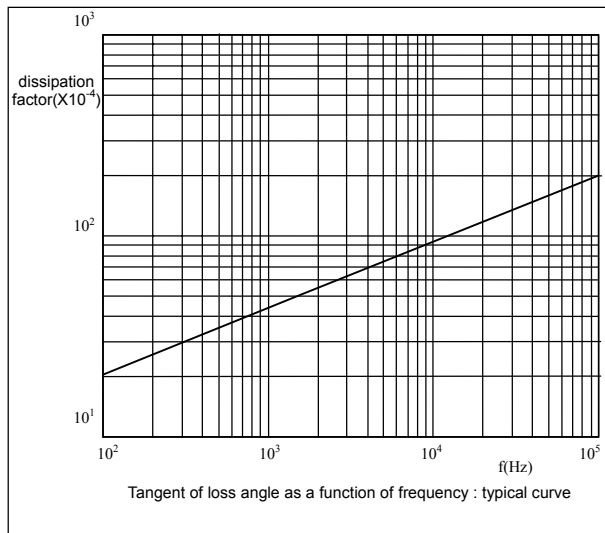
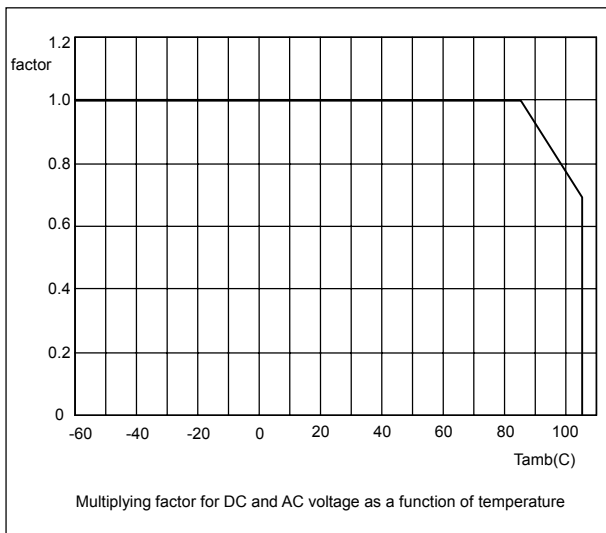
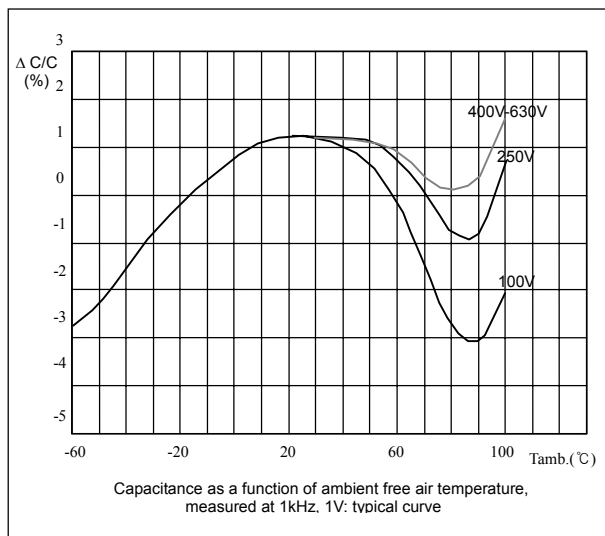
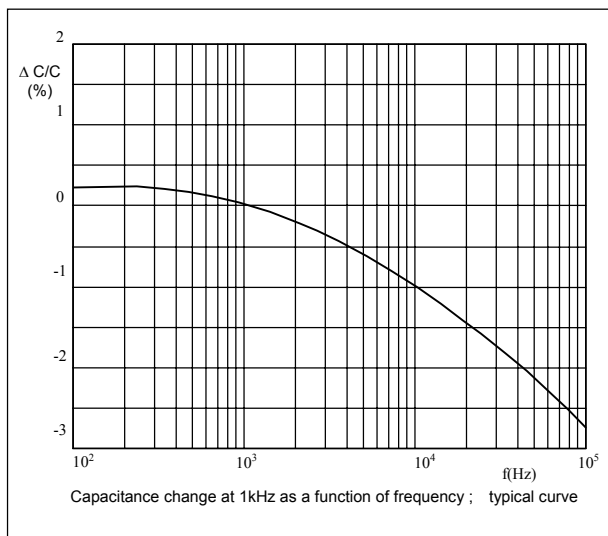

MAXIMUM RMS VOLTAGE (SINEWAVE) AS A FUNCTION OF FREQUENCY

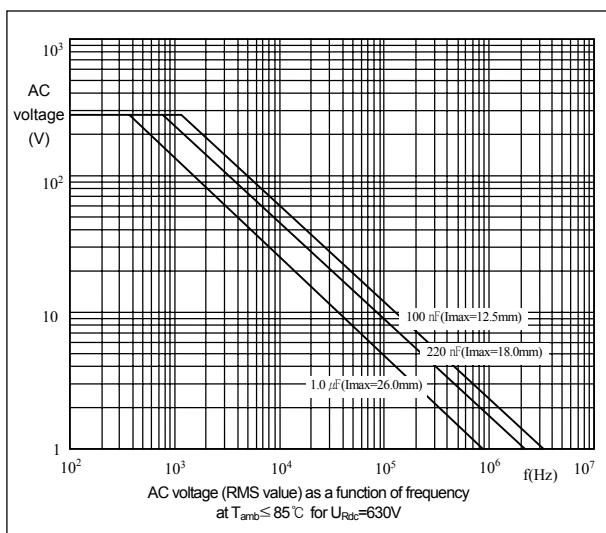
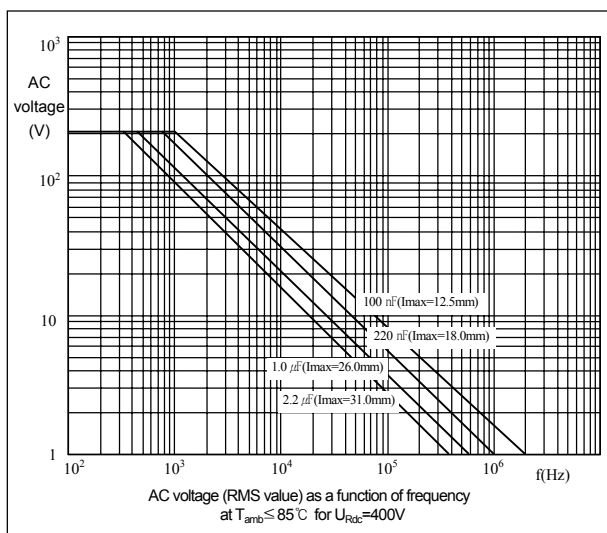
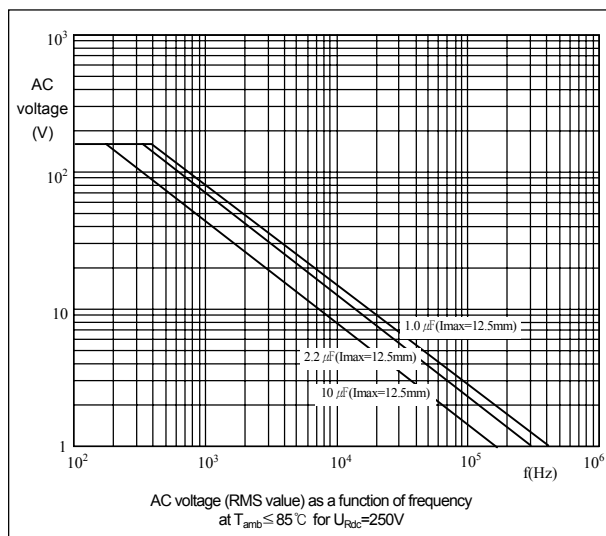
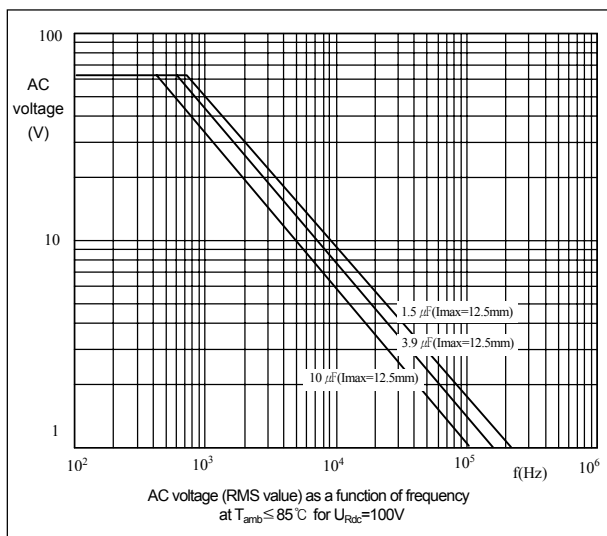

APPLICATION NOTE

These capacitors are not suitable for mains application as across-the-line capacitors without additional protection.

To select this capacitor for a certain application, 6 conditions must be checked :

1. The peak voltage (V_p) shall not be greater than the rated DC voltage.
2. The peak-to-peak voltage (V_{p-p}) shall not be greater than $2\sqrt{2}$ times the rated AC voltage to avoid the ionization inception level.
3. The peak current (I_p) shall not exceed the maximum peak current, defined as maximum voltage pulse slope (dV/dt) multiplied by the capacitance.

$$I_p \text{ max.} = C (dV/dt) \text{ max}$$

Or the voltage pulse slope shall not exceed the rated voltage pulse slope. If the pulse voltage is Lower than the rated voltage, the values of the table may be multiplied by V_{Rdc} and divided by the applied voltage.

4. The dissipated power shall not be greater than the maximum permissible power dissipation stated above.
5. The free air ambient temperature for the capacitor is not exceeding the category temperature.
6. Since all metallized film capacitors have an intrinsically active flammability risk, it is recommended that these capacitors should only be used in circuits where the power can be limited to less than 5W to the capacitor should a failure occur.

PRODUCT MARKING

The capacitors are marked in black ink on the side with the following information :

- . Rated capacitance in code according to IEC 60062(224)
- . Tolerance on rated capacitance : J = $\pm 5\%$, K = $\pm 10\%$
- . Rated DC voltage(250)
- . Product Type (P369)
- . Code for dielectric material(MKT)
- . Batch number code(1341101)

Example of marking

224 J 250
P369 MKT
1341101

224 J 250.
P369 MKT
1341101

