

LINEAR INTEGRATED CIRCUIT

12 V VOLTAGE REGULATOR

- OUTPUT CURRENT > 500 mA
- TIGHT TOLERANCE for OUTPUT VOLTAGE
- LOAD REGULATION LESS THAN 1%
- RIPPLE REJECTION 60 dB TYPICAL
- LOW OUTPUT IMPEDANCE
- EXCELLENT TRANSIENT RESPONSE
- HIGH TEMPERATURE STABILITY

The TDA 1412 is a silicon monolithic voltage regulator in Jedec TO-126 plastic package which can supply more than 500 mA. It incorporates the following functions:

- internal overload protection
- short-circuit protection

The TDA 1412 can be used for voltage regulation in consumer applications.

ABSOLUTE MAXIMUM RATINGS

| | | | |
|----------------------------|--|------------|------------------|
| V_i | Input supply voltage | 27 | V |
| P_{tot} | Total power dissipation at $T_{amb} \leq 25^\circ\text{C}$ | 1.25 | W |
| | at $T_{case} \leq 25^\circ\text{C}$ | 14 | W |
| $\rightarrow T_{stg}, T_j$ | Storage and junction temperature | -55 to 150 | $^\circ\text{C}$ |
| T_{op} | Operating temperature | 0 to 70 | $^\circ\text{C}$ |

MECHANICAL DATA

Dimensions in mm

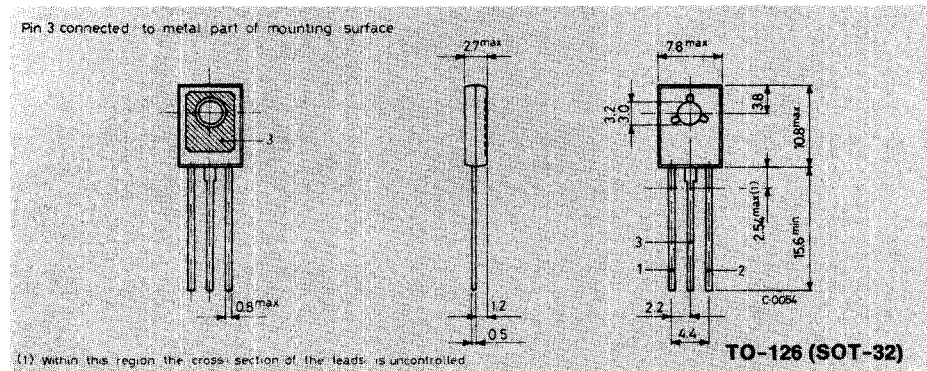

TDA 1412

BLOCK DIAGRAM

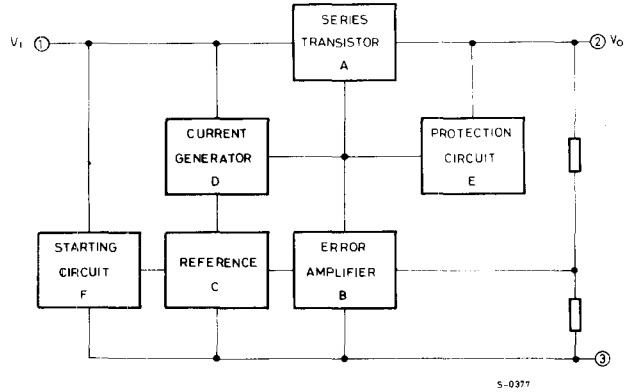

SCHEMATIC DIAGRAM

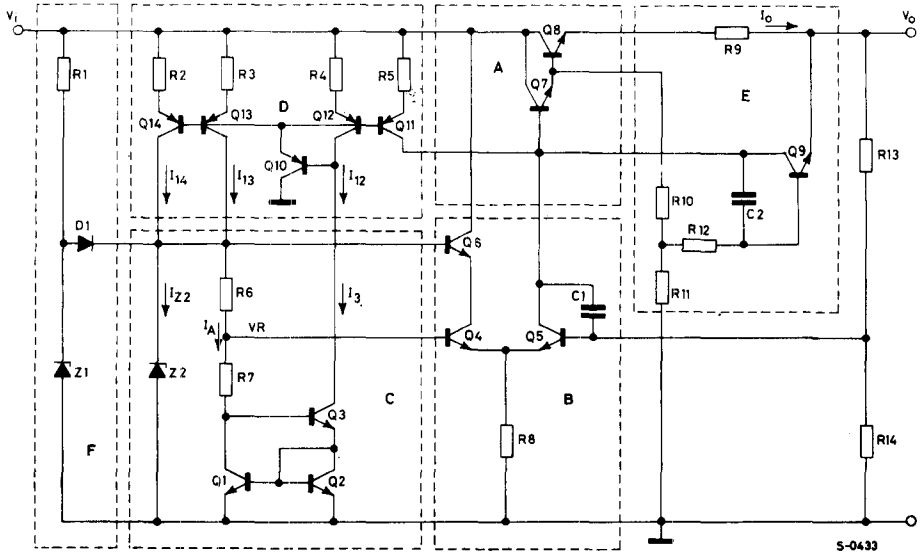

TEST CIRCUIT with output characteristic

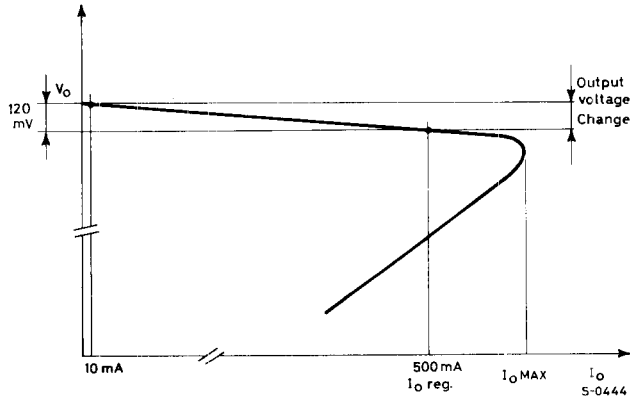
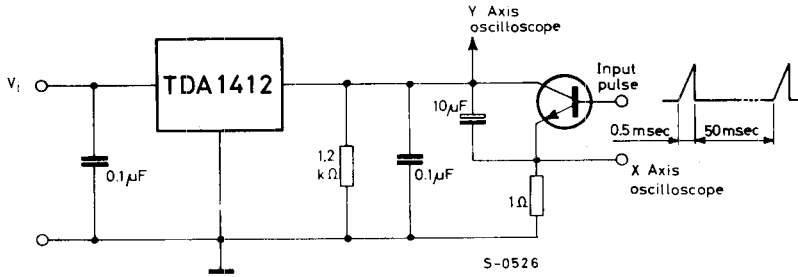

THERMAL DATA

| | | | |
|------------------|-------------------------------------|-----|----------|
| $R_{th\ j-case}$ | Thermal resistance junction-case | max | 9 °C/W |
| $R_{th\ j-amb}$ | Thermal resistance junction-ambient | max | 100 °C/W |

TDA 1412

ELECTRICAL CHARACTERISTICS

($T_i = 25\text{ °C}$, $V_i = 21\text{ V}$ unless otherwise specified)

| Parameter | Test conditions | Min. | Typ. | Max. | Unit |
|--|--|------|-------------|------|---------------|
| V_o Output voltage | $14.5\text{ V} \leq V_i \leq 27\text{ V}$ $I_o = 10\text{ mA}$ $C_L = 10\text{ }\mu\text{F}$ | 11.4 | 12 | 12.6 | V |
| ΔV_o^* Load regulation | $I_o = 10\text{ to }500\text{ mA}$ $C_L = 10\text{ }\mu\text{F}$ | | 0.3 | 1 | %V |
| I_o^* Regulated output current | $\frac{\Delta V_o}{V_o} \leq 1\%$ | 500 | 720 | | mA |
| $I_o\text{MAX}^*$ Maximum output current | $T_{\text{case}} = 25\text{ °C}$ $T_{\text{case}} = 70\text{ °C}$ | | 0.75 0.8 | 1 | A A |
| I_{sc} Output short-circuit current | $V_o = 0$ | | 100 | 200 | mA |
| I_d Quiescent drain current | $V_i = 27\text{ V}$ $I_o = 0$ | | 10 | | mA |
| ΔV_o Line regulation | $V_i = 14.5\text{ to }21\text{ V}$ $I_o = 10\text{ mA}$ $C_L = 10\text{ }\mu\text{F}$ | | 6 | 33 | mV |
| $\frac{\Delta V_o}{\Delta T_{\text{amb}}}$ Temperature coefficient | $I_o = 10\text{ mA}$ $C_L = 10\text{ }\mu\text{F}$ $T_{\text{amb}} = 0\text{ to }70\text{ °C}$ | | 1.2 | | mV/°C |
| e_N Output noise voltage | $I_o = 10\text{ mA}$ $C_L^{**} = 20\text{ }\mu\text{F}$ B = 10 Hz to 100 kHz | | 150 | | μV |
| R_o Output resistance | $I_o = 500\text{ mA}$ | | 20 | | m Ω |
| SVR Supply voltage rejection | $V_i = 19\text{ V}$ $I_o = 10\text{ mA}$ $\Delta V_i = 4\text{ V peak to peak}$ f = 100 Hz $C_L = 10\text{ }\mu\text{F}$ | 46 | 60 | | dB |

* Refer to the test circuit

** Tantalum capacitor

Typical output voltage versus output current

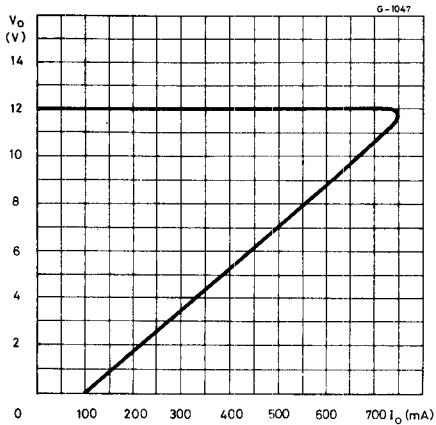

Power rating chart

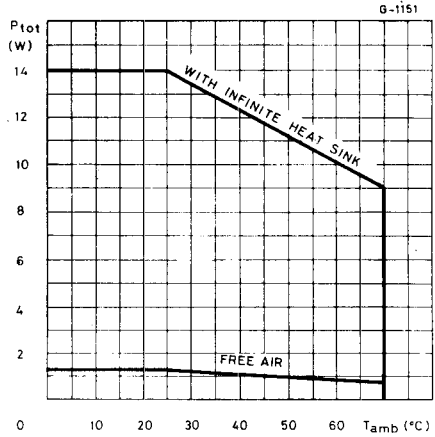

Typical regulated output current versus junction temperature

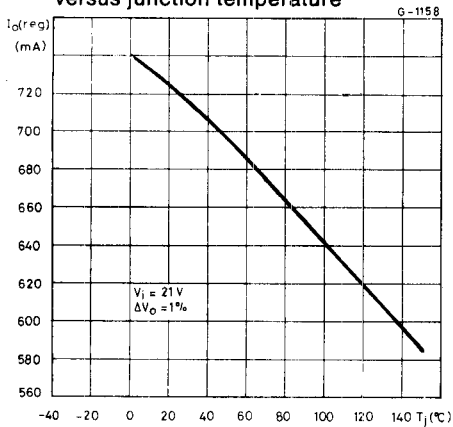

Maximum output current versus junction temperature

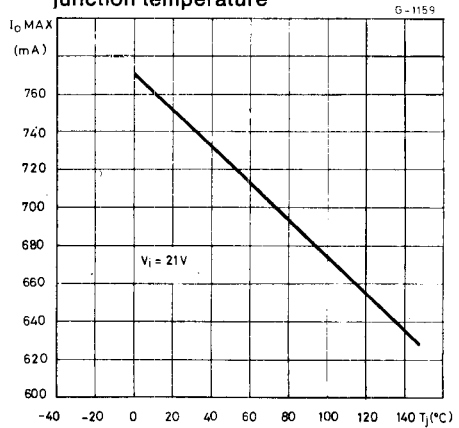

TDA 1412

Typical dropout voltage versus junction temperature

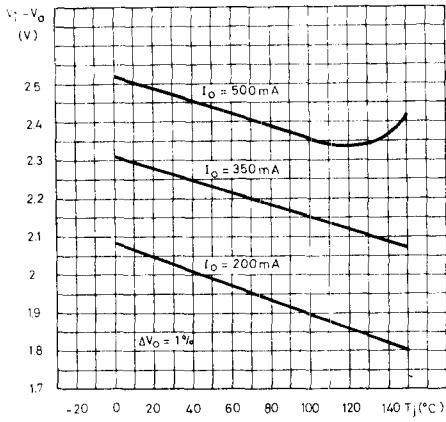

Typical short-circuit current versus input voltage

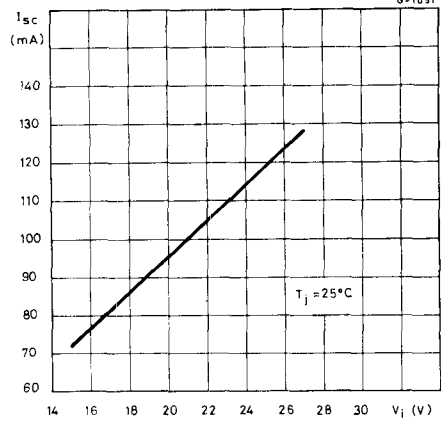

Typical short-circuit current versus junction temperature

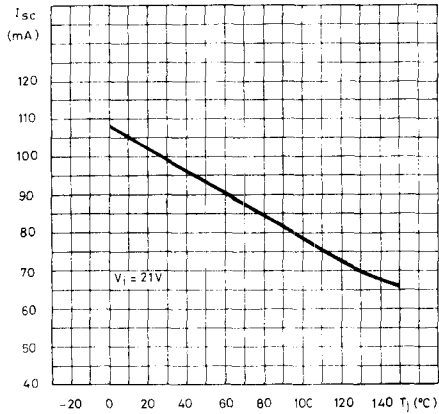

Typical quiescent drain current versus junction temperature

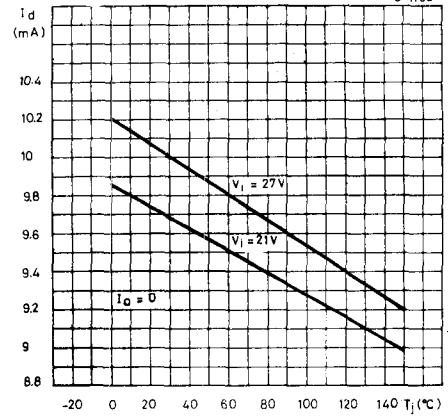

Typical quiescent drain current variation versus junction temperature

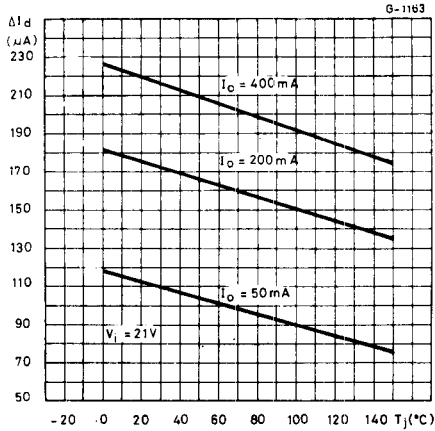

Typical supply voltage rejection versus frequency

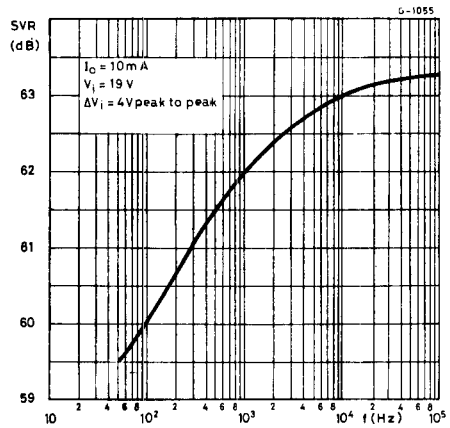

Typical supply voltage rejection versus regulated output current

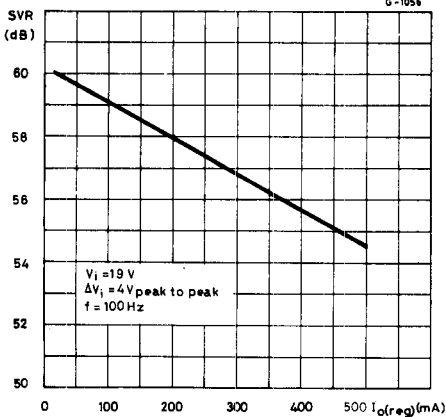

Typical output resistance versus frequency

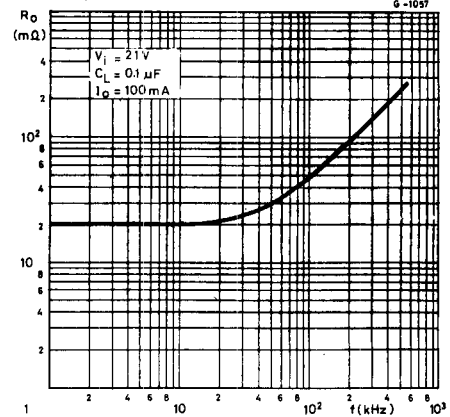

TDA 1412

Typical line transient response

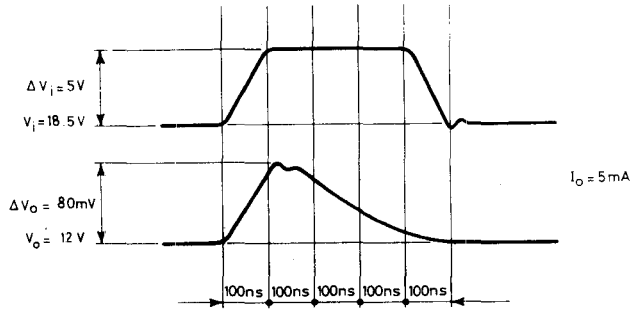

S-0445

APPLICATION INFORMATION

Typical connection circuit

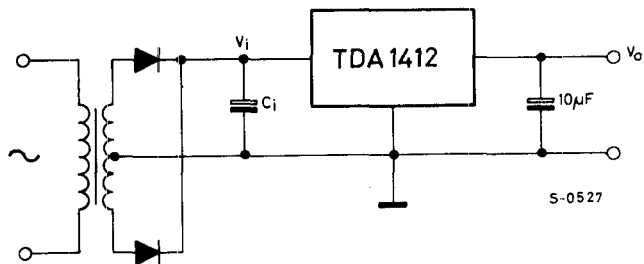

APPLICATION INFORMATION (continued)

Negative output voltage circuit

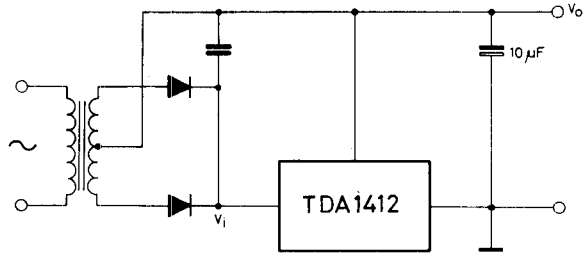

S-0528

Parallel connected voltage regulators and its output characteristics

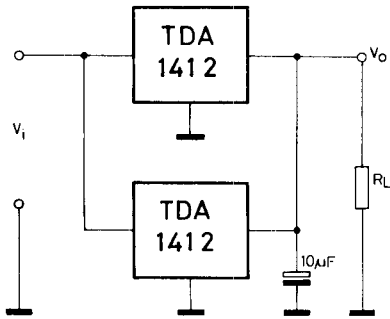

S-0529

