

TOSHIBA Bipolar Linear Integrated Circuit Silicon Monolithic

## TA79005S,TA79006S,TA79007S,TA79008S,TA79009S,TA79010S, TA79012S,TA79015S,TA79018S,TA79020S,TA79024S

Output Current of 1A, Three-Terminal Negative Voltage Regulators

-5 V, -6 V, -7 V, -8 V, -9 V, -10 V, -12 V, -15 V, -18 V, -20 V, -24 V

### Features

- Suitable for CMOS, TTL, and the other digital IC power supply.
- Internal thermal overload protecting.
- Internal short circuit current limiting.
- Maximum output current of 1.0 A.
- Metal fin (tab) is fully covered with mold resin.  
(TO-220 NIS package)

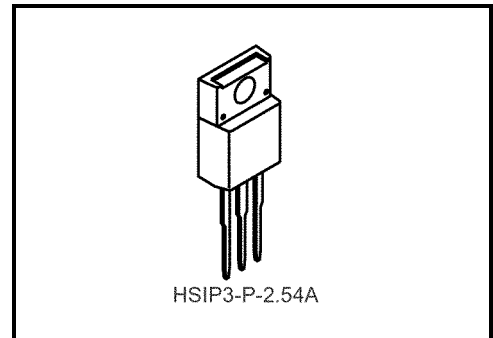

Weight: 1.7 g (typ.)

### Pin Assignment

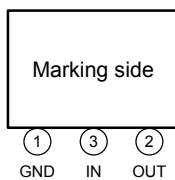

### Equivalent Circuit

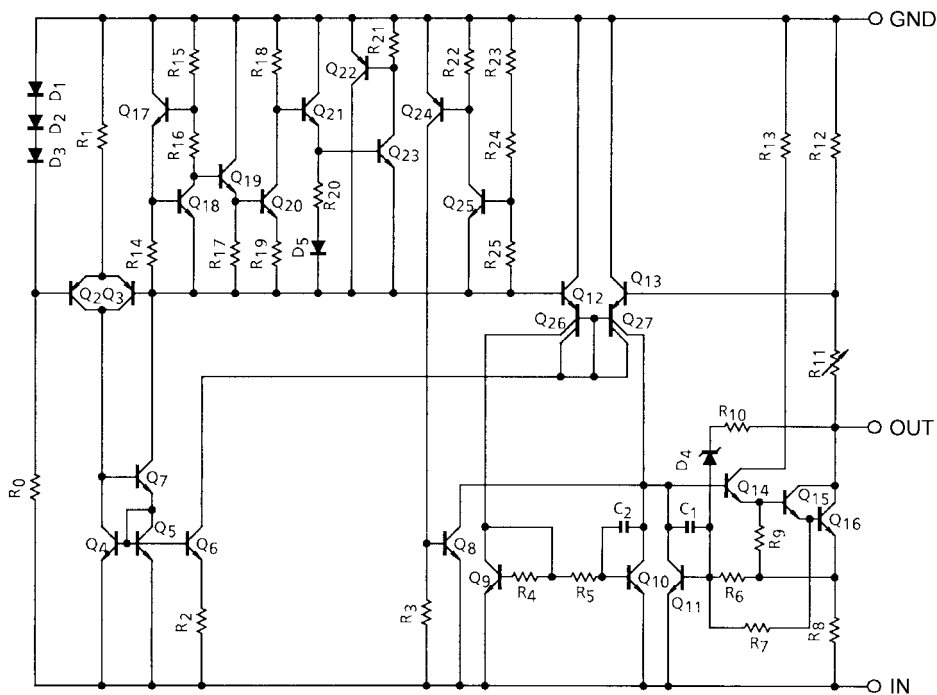

## Maximum Ratings (Ta = 25°C)

Characteristics		Symbol	Rating	Unit
Input voltage	TA79005S	V <sub>IN</sub>	-35	V
	TA79006S			
	TA79007S			
	TA79008S			
	TA79009S			
	TA79010S			
	TA79012S			
	TA79015S			
	TA79018S			
	TA79020S		-40	
	TA79024S			
Power dissipation	(Ta = 25°C)	P <sub>D</sub>	2	W
	(Tc = 25°C)		20	
Operating temperature		T <sub>opr</sub>	-30~85	°C
Storage temperature		T <sub>stg</sub>	-55~150	°C
Junction temperature		T <sub>j</sub>	150	°C
Thermal resistance		R <sub>th(j-c)</sub>	6.25	°C/W
		R <sub>th(j-a)</sub>	62.5	

## TA79005S

### Electrical Characteristics

(Unless otherwise specified,  $V_{IN} = -10\text{ V}$ ,  $I_{OUT} = 500\text{ mA}$ ,  $0^\circ\text{C} \leq T_j \leq 125^\circ\text{C}$ ,  $C_{IN} = 0.33\text{ }\mu\text{F}$ ,  $C_{OUT} = 0.1\text{ }\mu\text{F}$ )

Characteristics	Symbol	Test Circuit	Test Condition	Min	Typ.	Max	Unit	
Output voltage	$V_{OUT}$	1	$T_j = 25^\circ\text{C}$	-5.2	-5.0	-4.8	V	
Line regulation	Reg-line	1	$T_j = 25^\circ\text{C}$	$-12\text{ V} \leq V_{IN} \leq -8\text{ V}$	—	7	50	mV
				$-25\text{ V} \leq V_{IN} \leq -7\text{ V}$	—	35	100	
Load regulation	Reg-load	1	$T_j = 25^\circ\text{C}$	$5\text{ mA} \leq I_{OUT} \leq 1.5\text{ A}$	—	11	100	mV
				$250\text{ mA} \leq I_{OUT} \leq 750\text{ mA}$	—	4	50	
Output voltage	$V_{OUT}$	1	$T_j = 25^\circ\text{C}$	-5.25	—	-4.75	V	
Quiescent current	$I_B$	1	$T_j = 25^\circ\text{C}$	—	4.3	8.0	mA	
Quiescent current change	Line	$\Delta I_B$	$T_j = 25^\circ\text{C}$	$-25\text{ V} \leq V_{IN} \leq -7\text{ V}$	—	—	1.3	mA
	Load			$5\text{ mA} \leq I_{OUT} \leq 1.0\text{ A}$	—	—	0.5	
Output noise voltage	$V_{NO}$	2	$T_a = 25^\circ\text{C}$ , $I_{OUT} = 20\text{ mA}$ , $10\text{ Hz} \leq f \leq 100\text{ kHz}$	—	40	—	$\mu\text{V}_{rms}$	
Ripple rejection	R.R.	3	$f = 120\text{ Hz}$ , $I_{OUT} = 20\text{ mA}$ , $T_j = 25^\circ\text{C}$	63	70	—	dB	
Short circuit current limit	$I_{SC}$	1	$T_j = 25^\circ\text{C}$	—	1.9	—	A	
Dropout voltage	$V_D$	1	$T_j = 25^\circ\text{C}$ , $I_{OUT} = 1.0\text{ A}$	—	2.0	—	V	
Average temperature coefficient of output voltage	$T_{CVO}$	1	$I_{OUT} = 5.0\text{ mA}$	—	0.6	—	$\text{mV}/^\circ\text{C}$	

## TA79006S

### Electrical Characteristics

(Unless otherwise specified,  $V_{IN} = -11\text{ V}$ ,  $I_{OUT} = 500\text{ mA}$ ,  $0^\circ\text{C} \leq T_j \leq 125^\circ\text{C}$ ,  $C_{IN} = 0.33\ \mu\text{F}$ ,  $C_{OUT} = 0.1\ \mu\text{F}$ )

Characteristics	Symbol	Test Circuit	Test Condition	Min	Typ.	Max	Unit	
Output voltage	$V_{OUT}$	1	$T_j = 25^\circ\text{C}$	-6.25	-6.0	-5.75	V	
Line regulation	Reg-line	1	$T_j = 25^\circ\text{C}$	$-13\text{ V} \leq V_{IN} \leq -9\text{ V}$	—	9	60	mV
				$-25\text{ V} \leq V_{IN} \leq -8\text{ V}$	—	43	120	
Load regulation	Reg-load	1	$T_j = 25^\circ\text{C}$	$5\text{ mA} \leq I_{OUT} \leq 1.5\text{ A}$	—	13	120	mV
				$250\text{ mA} \leq I_{OUT} \leq 750\text{ mA}$	—	5	60	
Output voltage	$V_{OUT}$	1	$T_j = 25^\circ\text{C}$	-6.3	—	-5.7	V	
Quiescent current	$I_B$	1	$T_j = 25^\circ\text{C}$	—	4.3	8.0	mA	
Quiescent current change	Line	$\Delta I_B$	$T_j = 25^\circ\text{C}$	$-25\text{ V} \leq V_{IN} \leq -8\text{ V}$	—	—	1.3	mA
	Load			$5\text{ mA} \leq I_{OUT} \leq 1.0\text{ A}$	—	—	0.5	
Output noise voltage	$V_{NO}$	2	$T_a = 25^\circ\text{C}$ , $I_{OUT} = 20\text{ mA}$ , $10\text{ Hz} \leq f \leq 100\text{ kHz}$	—	45	—	$\mu\text{V}_{rms}$	
Ripple rejection	R.R.	3	$f = 120\text{ Hz}$ , $I_{OUT} = 20\text{ mA}$ , $T_j = 25^\circ\text{C}$	61	68	—	dB	
Short circuit current limit	$I_{SC}$	1	$T_j = 25^\circ\text{C}$	—	1.9	—	A	
Dropout voltage	$V_D$	1	$T_j = 25^\circ\text{C}$ , $I_{OUT} = 1.0\text{ A}$	—	2.0	—	V	
Average temperature coefficient of output voltage	$T_{CVO}$	1	$I_{OUT} = 5.0\text{ mA}$	—	0.7	—	$\text{mV}/^\circ\text{C}$	

## TA79007S

### Electrical Characteristics

(Unless otherwise specified,  $V_{IN} = -12\text{ V}$ ,  $I_{OUT} = 500\text{ mA}$ ,  $0^\circ\text{C} \leq T_j \leq 125^\circ\text{C}$ ,  $C_{IN} = 0.33\text{ }\mu\text{F}$ ,  $C_{OUT} = 0.1\text{ }\mu\text{F}$ )

Characteristics	Symbol	Test Circuit	Test Condition	Min	Typ.	Max	Unit	
Output voltage	$V_{OUT}$	1	$T_j = 25^\circ\text{C}$	-7.28	-7.0	-6.72	V	
Line regulation	Reg-line	1	$T_j = 25^\circ\text{C}$	$-15\text{ V} \leq V_{IN} \leq -10\text{ V}$	—	10	70	mV
				$-25\text{ V} \leq V_{IN} \leq -9\text{ V}$	—	45	140	
Load regulation	Reg-load	1	$T_j = 25^\circ\text{C}$	$5\text{ mA} \leq I_{OUT} \leq 1.5\text{ A}$	—	20	140	mV
				$250\text{ mA} \leq I_{OUT} \leq 750\text{ mA}$	—	7	70	
Output voltage	$V_{OUT}$	1	$T_j = 25^\circ\text{C}$	-7.35	—	-6.65	V	
Quiescent current	$I_B$	1	$T_j = 25^\circ\text{C}$	—	4.3	8.0	mA	
Quiescent current change	Line	$\Delta I_B$	$T_j = 25^\circ\text{C}$	$-25\text{ V} \leq V_{IN} \leq -9\text{ V}$	—	—	1.0	mA
	Load			$5\text{ mA} \leq I_{OUT} \leq 1.0\text{ A}$	—	—	0.5	
Output noise voltage	$V_{NO}$	2	$T_a = 25^\circ\text{C}$ , $I_{OUT} = 20\text{ mA}$ , $10\text{ Hz} \leq f \leq 100\text{ kHz}$	—	49	—	$\mu\text{V}_{rms}$	
Ripple rejection	R.R.	3	$f = 120\text{ Hz}$ , $I_{OUT} = 20\text{ mA}$ , $T_j = 25^\circ\text{C}$	60	67	—	dB	
Short circuit current limit	$I_{SC}$	1	$T_j = 25^\circ\text{C}$	—	1.9	—	A	
Dropout voltage	$V_D$	1	$T_j = 25^\circ\text{C}$ , $I_{OUT} = 1.0\text{ A}$	—	2.0	—	V	
Average temperature coefficient of output voltage	$T_{CVO}$	1	$I_{OUT} = 5.0\text{ mA}$	—	0.9	—	$\text{mV}/^\circ\text{C}$	

## TA79008S

### Electrical Characteristics

(Unless otherwise specified,  $V_{IN} = -14\text{ V}$ ,  $I_{OUT} = 500\text{ mA}$ ,  $0^\circ\text{C} \leq T_j \leq 125^\circ\text{C}$ ,  $C_{IN} = 0.33\text{ }\mu\text{F}$ ,  $C_{OUT} = 0.1\text{ }\mu\text{F}$ )

Characteristics	Symbol	Test Circuit	Test Condition	Min	Typ.	Max	Unit	
Output voltage	$V_{OUT}$	1	$T_j = 25^\circ\text{C}$	-8.3	-8.0	-7.7	V	
Line regulation	Reg-line	1	$T_j = 25^\circ\text{C}$	$-17\text{ V} \leq V_{IN} \leq -11\text{ V}$	—	11	80	mV
				$-25\text{ V} \leq V_{IN} \leq -10.5\text{ V}$	—	47	160	
Load regulation	Reg-load	1	$T_j = 25^\circ\text{C}$	$5\text{ mA} \leq I_{OUT} \leq 1.5\text{ A}$	—	26	160	mV
				$250\text{ mA} \leq I_{OUT} \leq 750\text{ mA}$	—	9	80	
Output voltage	$V_{OUT}$	1	$T_j = 25^\circ\text{C}$ $-23\text{ V} \leq V_{IN} \leq -10.5\text{ V}$ , $5\text{ mA} \leq I_{OUT} \leq 1.0\text{ A}$	-8.4	—	-7.6	V	
Quiescent current	$I_B$	1	$T_j = 25^\circ\text{C}$	—	4.3	8.0	mA	
Quiescent current change	Line	$\Delta I_B$	$T_j = 25^\circ\text{C}$	$-25\text{ V} \leq V_{IN} \leq -10.5\text{ V}$	—	—	1.0	mA
	Load			$5\text{ mA} \leq I_{OUT} \leq 1.0\text{ A}$	—	—	0.5	
Output noise voltage	$V_{NO}$	2	$T_a = 25^\circ\text{C}$ , $I_{OUT} = 20\text{ mA}$ , $10\text{ Hz} \leq f \leq 100\text{ kHz}$	—	52	—	$\mu\text{V}_{rms}$	
Ripple rejection	R.R.	3	$f = 120\text{ Hz}$ , $I_{OUT} = 20\text{ mA}$ , $T_j = 25^\circ\text{C}$	59	66	—	dB	
Short circuit current limit	$I_{SC}$	1	$T_j = 25^\circ\text{C}$	—	1.9	—	A	
Dropout voltage	$V_D$	1	$T_j = 25^\circ\text{C}$ , $I_{OUT} = 1.0\text{ A}$	—	2.0	—	V	
Average temperature coefficient of output voltage	$T_{CVO}$	1	$I_{OUT} = 5.0\text{ mA}$	—	1.0	—	$\text{mV}/^\circ\text{C}$	

## TA79009S

### Electrical Characteristics

(Unless otherwise specified,  $V_{IN} = -15\text{ V}$ ,  $I_{OUT} = 500\text{ mA}$ ,  $0^\circ\text{C} \leq T_j \leq 125^\circ\text{C}$ ,  $C_{IN} = 0.33\text{ }\mu\text{F}$ ,  $C_{OUT} = 0.1\text{ }\mu\text{F}$ )

Characteristics	Symbol	Test Circuit	Test Condition	Min	Typ.	Max	Unit	
Output voltage	$V_{OUT}$	1	$T_j = 25^\circ\text{C}$	-9.3	-9.0	-8.7	V	
Line regulation	Reg-line	1	$T_j = 25^\circ\text{C}$	$-19\text{ V} \leq V_{IN} \leq -13\text{ V}$	—	11	82	mV
				$-26\text{ V} \leq V_{IN} \leq -11.5\text{ V}$	—	48	162	
Load regulation	Reg-load	1	$T_j = 25^\circ\text{C}$	$5\text{ mA} \leq I_{OUT} \leq 1.5\text{ A}$	—	33	162	mV
				$250\text{ mA} \leq I_{OUT} \leq 750\text{ mA}$	—	11	82	
Output voltage	$V_{OUT}$	1	$T_j = 25^\circ\text{C}$	-9.4	—	-8.6	V	
Quiescent current	$I_B$	1	$T_j = 25^\circ\text{C}$	—	4.3	8.0	mA	
Quiescent current change	Line	$\Delta I_B$	$T_j = 25^\circ\text{C}$	$-26.5\text{ V} \leq V_{IN} \leq -13\text{ V}$	—	—	1.0	mA
	Load			$5\text{ mA} \leq I_{OUT} \leq 1.0\text{ A}$	—	—	0.5	
Output noise voltage	$V_{NO}$	2	$T_a = 25^\circ\text{C}$ , $I_{OUT} = 20\text{ mA}$ , $10\text{ Hz} \leq f \leq 100\text{ kHz}$	—	60	—	$\mu\text{V}_{rms}$	
Ripple rejection	R.R.	3	$f = 120\text{ Hz}$ , $I_{OUT} = 20\text{ mA}$ , $T_j = 25^\circ\text{C}$	57	64	—	dB	
Short circuit current limit	$I_{SC}$	1	$T_j = 25^\circ\text{C}$	—	1.9	—	A	
Dropout voltage	$V_D$	1	$T_j = 25^\circ\text{C}$ , $I_{OUT} = 1.0\text{ A}$	—	2.0	—	V	
Average temperature coefficient of output voltage	$T_{CVO}$	1	$I_{OUT} = 5.0\text{ mA}$	—	1.1	—	$\text{mV}/^\circ\text{C}$	

## TA79010S

### Electrical Characteristics

(Unless otherwise specified,  $V_{IN} = -16\text{ V}$ ,  $I_{OUT} = 500\text{ mA}$ ,  $0^\circ\text{C} \leq T_j \leq 125^\circ\text{C}$ ,  $C_{IN} = 0.33\text{ }\mu\text{F}$ ,  $C_{OUT} = 0.1\text{ }\mu\text{F}$ )

Characteristics	Symbol	Test Circuit	Test Condition	Min	Typ.	Max	Unit	
Output voltage	$V_{OUT}$	1	$T_j = 25^\circ\text{C}$	-10.4	-10.0	-9.6	V	
Line regulation	Reg-line	1	$T_j = 25^\circ\text{C}$	$-20\text{ V} \leq V_{IN} \leq -14\text{ V}$	—	12	90	mV
				$-27\text{ V} \leq V_{IN} \leq -12.5\text{ V}$	—	50	180	
Load regulation	Reg-load	1	$T_j = 25^\circ\text{C}$	$5\text{ mA} \leq I_{OUT} \leq 1.5\text{ A}$	—	40	180	mV
				$250\text{ mA} \leq I_{OUT} \leq 750\text{ mA}$	—	13	90	
Output voltage	$V_{OUT}$	1	$T_j = 25^\circ\text{C}$	-10.5	—	-9.5	V	
Quiescent current	$I_B$	1	$T_j = 25^\circ\text{C}$	—	4.4	8.0	mA	
Quiescent current change	Line	$\Delta I_B$	$T_j = 25^\circ\text{C}$	$-27.5\text{ V} \leq V_{IN} \leq -14\text{ V}$	—	—	1.0	mA
	Load			$5\text{ mA} \leq I_{OUT} \leq 1.0\text{ A}$	—	—	0.5	
Output noise voltage	$V_{NO}$	2	$T_a = 25^\circ\text{C}$ , $I_{OUT} = 20\text{ mA}$ , $10\text{ Hz} \leq f \leq 100\text{ kHz}$	—	65	—	$\mu\text{V}_{rms}$	
Ripple rejection	R.R.	3	$f = 120\text{ Hz}$ , $I_{OUT} = 20\text{ mA}$ , $T_j = 25^\circ\text{C}$	57	63	—	dB	
Short circuit current limit	$I_{SC}$	1	$T_j = 25^\circ\text{C}$	—	1.9	—	A	
Dropout voltage	$V_D$	1	$T_j = 25^\circ\text{C}$ , $I_{OUT} = 1.0\text{ A}$	—	2.0	—	V	
Average temperature coefficient of output voltage	$T_{CVO}$	1	$I_{OUT} = 5.0\text{ mA}$	—	1.3	—	$\text{mV}/^\circ\text{C}$	



## TA79012S

### Electrical Characteristics

(Unless otherwise specified,  $V_{IN} = -19\text{ V}$ ,  $I_{OUT} = 500\text{ mA}$ ,  $0^\circ\text{C} \leq T_j \leq 125^\circ\text{C}$ ,  $C_{IN} = 0.33\text{ }\mu\text{F}$ ,  $C_{OUT} = 0.1\text{ }\mu\text{F}$ )

Characteristics	Symbol	Test Circuit	Test Condition	Min	Typ.	Max	Unit	
Output voltage	$V_{OUT}$	1	$T_j = 25^\circ\text{C}$	-12.5	-12.0	-11.5	V	
Line regulation	Reg-line	1	$T_j = 25^\circ\text{C}$	$-22\text{ V} \leq V_{IN} \leq -16\text{ V}$	—	13	120	mV
				$-30\text{ V} \leq V_{IN} \leq -14.5\text{ V}$	—	55	240	
Load regulation	Reg-load	1	$T_j = 25^\circ\text{C}$	$5\text{ mA} \leq I_{OUT} \leq 1.5\text{ A}$	—	46	240	mV
				$250\text{ mA} \leq I_{OUT} \leq 750\text{ mA}$	—	17	120	
Output voltage	$V_{OUT}$	1	$T_j = 25^\circ\text{C}$	-12.6	—	-11.4	V	
Quiescent current	$I_B$	1	$T_j = 25^\circ\text{C}$	—	4.4	8.0	mA	
Quiescent current change	Line	$\Delta I_B$	$T_j = 25^\circ\text{C}$	$-30\text{ V} \leq V_{IN} \leq -14.5\text{ V}$	—	—	1.0	mA
	Load			$5\text{ mA} \leq I_{OUT} \leq 1.0\text{ A}$	—	—	0.5	
Output noise voltage	$V_{NO}$	2	$T_a = 25^\circ\text{C}$ , $I_{OUT} = 20\text{ mA}$ , $10\text{ Hz} \leq f \leq 100\text{ kHz}$	—	75	—	$\mu\text{V}_{rms}$	
Ripple rejection	R.R.	3	$f = 120\text{ Hz}$ , $I_{OUT} = 20\text{ mA}$ , $T_j = 25^\circ\text{C}$	54	61	—	dB	
Short circuit current limit	$I_{SC}$	1	$T_j = 25^\circ\text{C}$	—	1.9	—	A	
Dropout voltage	$V_D$	1	$T_j = 25^\circ\text{C}$ , $I_{OUT} = 1.0\text{ A}$	—	2.0	—	V	
Average temperature coefficient of output voltage	$T_{CVO}$	1	$I_{OUT} = 5.0\text{ mA}$	—	1.6	—	$\text{mV}/^\circ\text{C}$	

## TA79015S

### Electrical Characteristics

(Unless otherwise specified,  $V_{IN} = -23\text{ V}$ ,  $I_{OUT} = 500\text{ mA}$ ,  $0^\circ\text{C} \leq T_j \leq 125^\circ\text{C}$ ,  $C_{IN} = 0.33\text{ }\mu\text{F}$ ,  $C_{OUT} = 0.1\text{ }\mu\text{F}$ )

Characteristics	Symbol	Test Circuit	Test Condition	Min	Typ.	Max	Unit			
Output voltage	$V_{OUT}$	1	$T_j = 25^\circ\text{C}$	-15.6	-15.0	-14.4	V			
Line regulation	Reg-line	1	$T_j = 25^\circ\text{C}$	$-26\text{ V} \leq V_{IN} \leq -20\text{ V}$	—	14	150	mV		
				$-30\text{ V} \leq V_{IN} \leq -17.5\text{ V}$	—	57	300			
Load regulation	Reg-load	1	$T_j = 25^\circ\text{C}$	$5\text{ mA} \leq I_{OUT} \leq 1.5\text{ A}$	—	68	300	mV		
				$250\text{ mA} \leq I_{OUT} \leq 750\text{ mA}$	—	25	150			
Output voltage	$V_{OUT}$	1	$T_j = 25^\circ\text{C}$	$-30\text{ V} \leq V_{IN} \leq -17.5\text{ V}$ , $5\text{ mA} \leq I_{OUT} \leq 1.0\text{ A}$		-15.75	—	-14.25	V	
Quiescent current	$I_B$	1	$T_j = 25^\circ\text{C}$	—	4.4	8.0	mA			
Quiescent current change	Line	$\Delta I_B$	1	$T_j = 25^\circ\text{C}$	$-30\text{ V} \leq V_{IN} \leq -17.5\text{ V}$		—	—	1.0	mA
	Load				$5\text{ mA} \leq I_{OUT} \leq 1.0\text{ A}$		—	—	0.5	
Output noise voltage	$V_{NO}$	2	$T_a = 25^\circ\text{C}$ , $I_{OUT} = 20\text{ mA}$ , $10\text{ Hz} \leq f \leq 100\text{ kHz}$		—	90	—	$\mu\text{V}_{rms}$		
Ripple rejection	R.R.	3	$f = 120\text{ Hz}$ , $I_{OUT} = 20\text{ mA}$ , $T_j = 25^\circ\text{C}$		53	60	—	dB		
Short circuit current limit	$I_{SC}$	1	$T_j = 25^\circ\text{C}$		—	1.9	—	A		
Dropout voltage	$V_D$	1	$T_j = 25^\circ\text{C}$ , $I_{OUT} = 1.0\text{ A}$		—	2.0	—	V		
Average temperature coefficient of output voltage	$T_{CVO}$	1	$I_{OUT} = 5.0\text{ mA}$		—	2.0	—	$\text{mV}/^\circ\text{C}$		

## TA79018S

### Electrical Characteristics

(Unless otherwise specified,  $V_{IN} = -27\text{ V}$ ,  $I_{OUT} = 500\text{ mA}$ ,  $0^\circ\text{C} \leq T_j \leq 125^\circ\text{C}$ ,  $C_{IN} = 0.33\text{ }\mu\text{F}$ ,  $C_{OUT} = 0.1\text{ }\mu\text{F}$ )

Characteristics	Symbol	Test Circuit	Test Condition	Min	Typ.	Max	Unit	
Output voltage	$V_{OUT}$	1	$T_j = 25^\circ\text{C}$	-18.7	-18.0	-17.3	V	
Line regulation	Reg-line	1	$T_j = 25^\circ\text{C}$	$-30\text{ V} \leq V_{IN} \leq -24\text{ V}$	—	25	180	mV
				$-33\text{ V} \leq V_{IN} \leq -21\text{ V}$	—	80	360	
Load regulation	Reg-load	1	$T_j = 25^\circ\text{C}$	$5\text{ mA} \leq I_{OUT} \leq 1.5\text{ A}$	—	110	360	mV
				$250\text{ mA} \leq I_{OUT} \leq 750\text{ mA}$	—	55	180	
Output voltage	$V_{OUT}$	1	$T_j = 25^\circ\text{C}$	-18.85	—	-17.15	V	
Quiescent current	$I_B$	1	$T_j = 25^\circ\text{C}$	—	4.5	8.0	mA	
Quiescent current change	Line	$\Delta I_B$	$T_j = 25^\circ\text{C}$	$-33\text{ V} \leq V_{IN} \leq -21\text{ V}$	—	—	1.0	mA
	Load			$5\text{ mA} \leq I_{OUT} \leq 1.0\text{ A}$	—	—	0.5	
Output noise voltage	$V_{NO}$	2	$T_a = 25^\circ\text{C}$ , $I_{OUT} = 20\text{ mA}$ , $10\text{ Hz} \leq f \leq 100\text{ kHz}$	—	110	—	$\mu\text{V}_{rms}$	
Ripple rejection	R.R.	3	$f = 120\text{ Hz}$ , $I_{OUT} = 20\text{ mA}$ , $T_j = 25^\circ\text{C}$	52	59	—	dB	
Short circuit current limit	$I_{SC}$	1	$T_j = 25^\circ\text{C}$	—	1.9	—	A	
Dropout voltage	$V_D$	1	$T_j = 25^\circ\text{C}$ , $I_{OUT} = 1.0\text{ A}$	—	2.0	—	V	
Average temperature coefficient of output voltage	$T_{CVO}$	1	$I_{OUT} = 5.0\text{ mA}$	—	2.5	—	$\text{mV}/^\circ\text{C}$	

## TA79020S

### Electrical Characteristics

(Unless otherwise specified,  $V_{IN} = -30\text{ V}$ ,  $I_{OUT} = 500\text{ mA}$ ,  $0^\circ\text{C} \leq T_j \leq 125^\circ\text{C}$ ,  $C_{IN} = 0.33\text{ }\mu\text{F}$ ,  $C_{OUT} = 0.1\text{ }\mu\text{F}$ )

Characteristics	Symbol	Test Circuit	Test Condition	Min	Typ.	Max	Unit	
Output voltage	$V_{OUT}$	1	$T_j = 25^\circ\text{C}$	-20.8	-20.0	-19.2	V	
Line regulation	Reg-line	1	$T_j = 25^\circ\text{C}$	$-32\text{ V} \leq V_{IN} \leq -26\text{ V}$	—	28	180	mV
				$-35\text{ V} \leq V_{IN} \leq -24\text{ V}$	—	104	360	
Load regulation	Reg-load	1	$T_j = 25^\circ\text{C}$	$5\text{ mA} \leq I_{OUT} \leq 1.5\text{ A}$	—	130	360	mV
				$250\text{ mA} \leq I_{OUT} \leq 750\text{ mA}$	—	70	180	
Output voltage	$V_{OUT}$	1	$T_j = 25^\circ\text{C}$	-21.0	—	-19.0	V	
Quiescent current	$I_B$	1	$T_j = 25^\circ\text{C}$	—	4.6	8.0	mA	
Quiescent current change	Line	$\Delta I_B$	$T_j = 25^\circ\text{C}$	$-36.5\text{ V} \leq V_{IN} \leq -25\text{ V}$	—	—	1.0	mA
	Load			$5\text{ mA} \leq I_{OUT} \leq 1.0\text{ A}$	—	—	0.5	
Output noise voltage	$V_{NO}$	2	$T_a = 25^\circ\text{C}$ , $I_{OUT} = 20\text{ mA}$ , $10\text{ Hz} \leq f \leq 100\text{ kHz}$	—	140	—	$\mu\text{V}_{rms}$	
Ripple rejection	R.R.	3	$f = 120\text{ Hz}$ , $I_{OUT} = 20\text{ mA}$ , $T_j = 25^\circ\text{C}$	50	57	—	dB	
Short circuit current limit	$I_{SC}$	1	$T_j = 25^\circ\text{C}$	—	1.9	—	A	
Dropout voltage	$V_D$	1	$T_j = 25^\circ\text{C}$ , $I_{OUT} = 1.0\text{ A}$	—	2.0	—	V	
Average temperature coefficient of output voltage	$T_{CVO}$	1	$I_{OUT} = 5.0\text{ mA}$	—	3.0	—	$\text{mV}/^\circ\text{C}$	

## TA79024S

### Electrical Characteristics

(Unless otherwise specified,  $V_{IN} = -33\text{ V}$ ,  $I_{OUT} = 500\text{ mA}$ ,  $0^\circ\text{C} \leq T_j \leq 125^\circ\text{C}$ ,  $C_{IN} = 0.33\text{ }\mu\text{F}$ ,  $C_{OUT} = 0.1\text{ }\mu\text{F}$ )

Characteristics	Symbol	Test Circuit	Test Condition	Min	Typ.	Max	Unit	
Output voltage	$V_{OUT}$	1	$T_j = 25^\circ\text{C}$	-25.0	-24.0	-23.0	V	
Line regulation	Reg-line	1	$T_j = 25^\circ\text{C}$	$-36\text{ V} \leq V_{IN} \leq -30\text{ V}$	—	31	240	mV
				$-38\text{ V} \leq V_{IN} \leq -27\text{ V}$	—	118	480	
Load regulation	Reg-load	1	$T_j = 25^\circ\text{C}$	$5\text{ mA} \leq I_{OUT} \leq 1.5\text{ A}$	—	150	480	mV
				$250\text{ mA} \leq I_{OUT} \leq 750\text{ mA}$	—	85	240	
Output voltage	$V_{OUT}$	1	$T_j = 25^\circ\text{C}$	-25.2	—	-22.8	V	
Quiescent current	$I_B$	1	$T_j = 25^\circ\text{C}$	—	4.6	8.0	mA	
Quiescent current change	Line	$\Delta I_B$	$T_j = 25^\circ\text{C}$	$-38\text{ V} \leq V_{IN} \leq -27\text{ V}$	—	—	1.0	mA
	Load			$5\text{ mA} \leq I_{OUT} \leq 1.0\text{ A}$	—	—	0.5	
Output noise voltage	$V_{NO}$	2	$T_a = 25^\circ\text{C}$ , $I_{OUT} = 20\text{ mA}$ , $10\text{ Hz} \leq f \leq 100\text{ kHz}$	—	170	—	$\mu\text{V}_{rms}$	
Ripple rejection	R.R.	3	$f = 120\text{ Hz}$ , $I_{OUT} = 20\text{ mA}$ , $T_j = 25^\circ\text{C}$	49	56	—	dB	
Short circuit current limit	$I_{SC}$	1	$T_j = 25^\circ\text{C}$	—	1.9	—	A	
Dropout voltage	$V_D$	1	$T_j = 25^\circ\text{C}$ , $I_{OUT} = 1.0\text{ A}$	—	2.0	—	V	
Average temperature coefficient of output voltage	$T_{CVO}$	1	$I_{OUT} = 5.0\text{ mA}$	—	3.5	—	$\text{mV}/^\circ\text{C}$	

## Test Circuit 1

$V_{OUT}$ , Reg-line, Reg-load,  $I_B$ ,  $\Delta I_B$ ,  $V_D$ ,  $T_{cvo}$

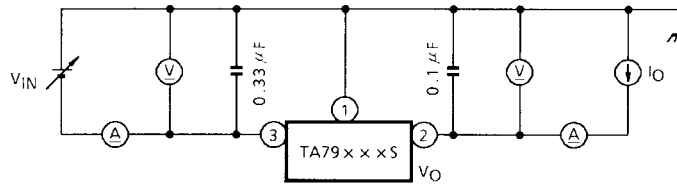

## Test Circuit 2

$V_{NO}$

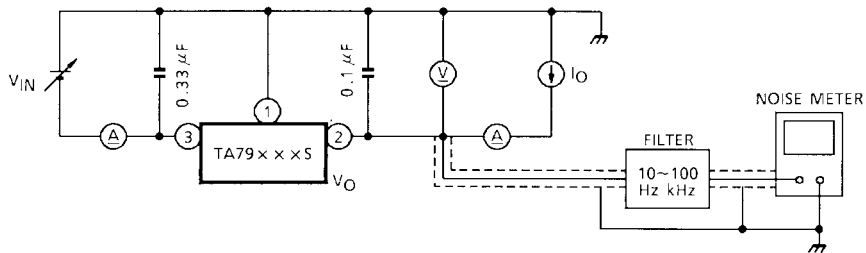

## Test Circuit 3

R.R.

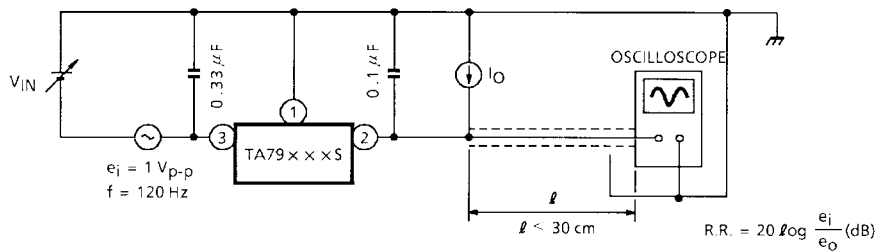

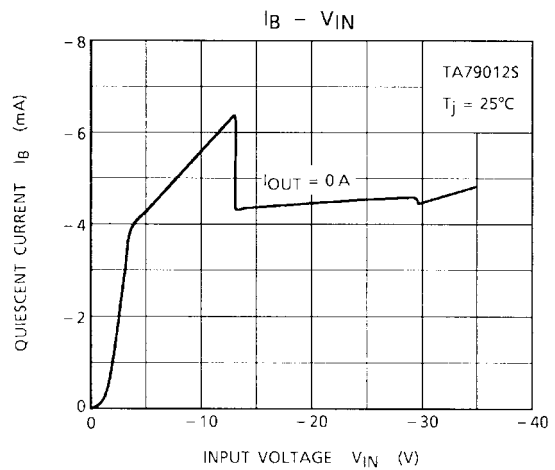
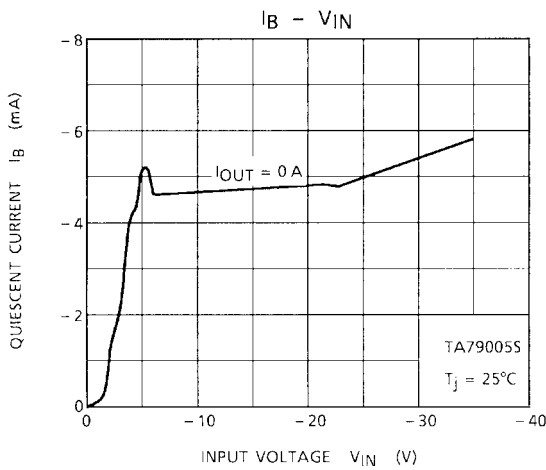
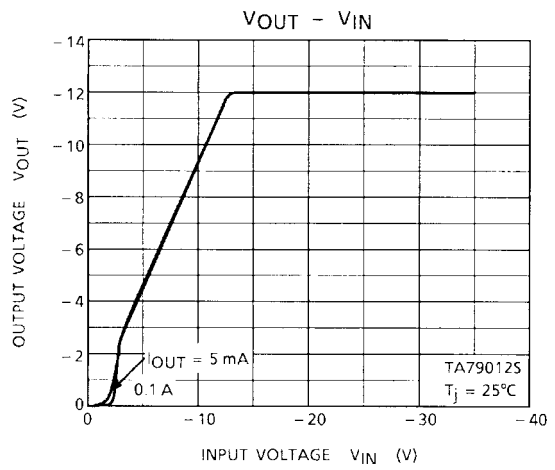
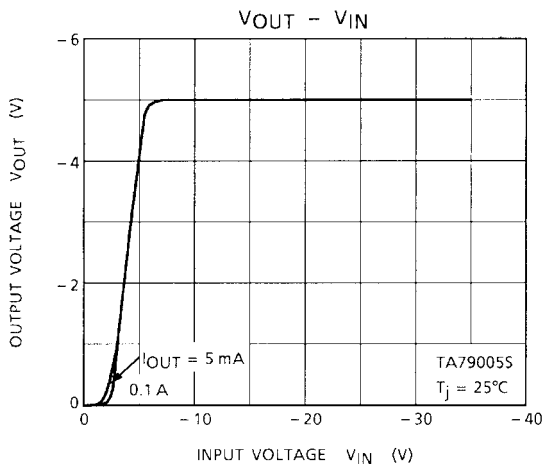
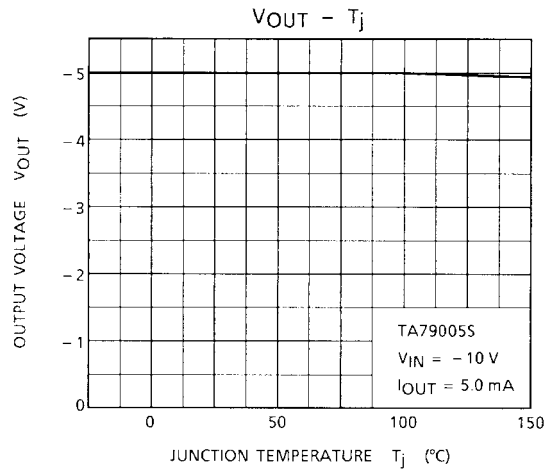
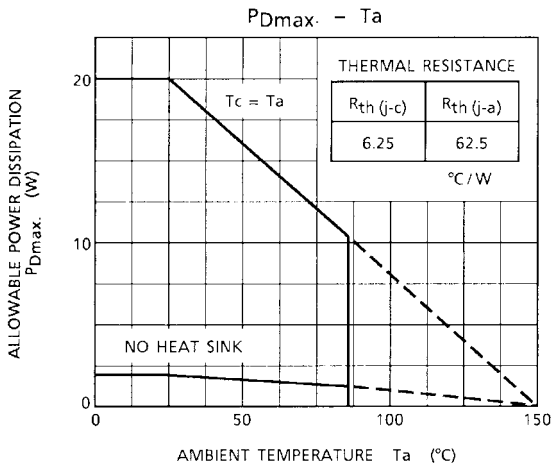

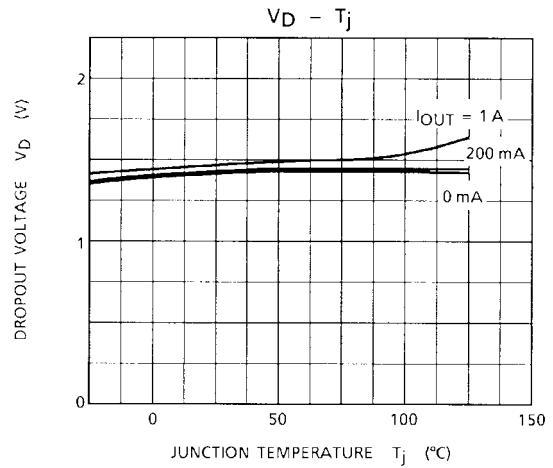
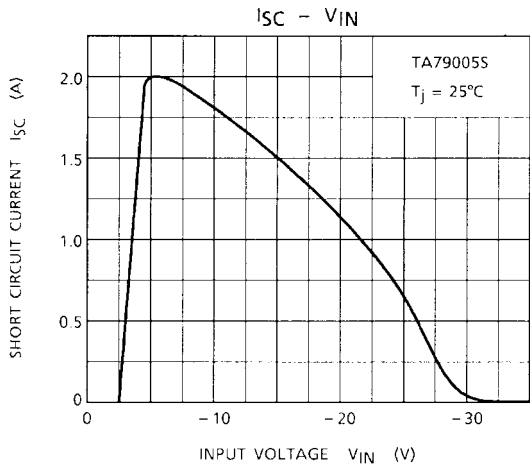
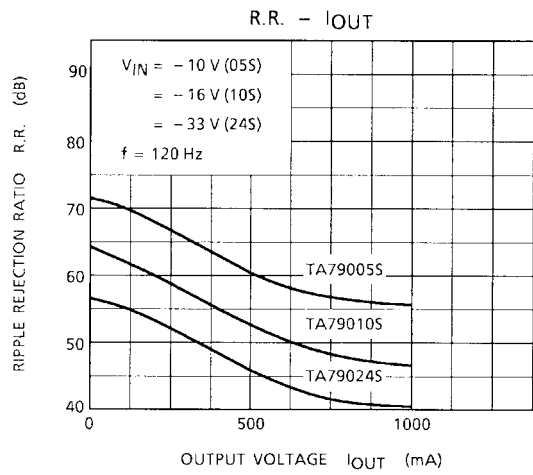
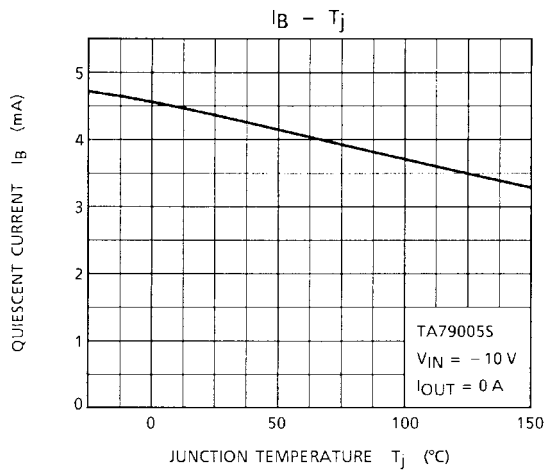



## Package Dimensions

HSIP3-P-2.54A

Unit: mm

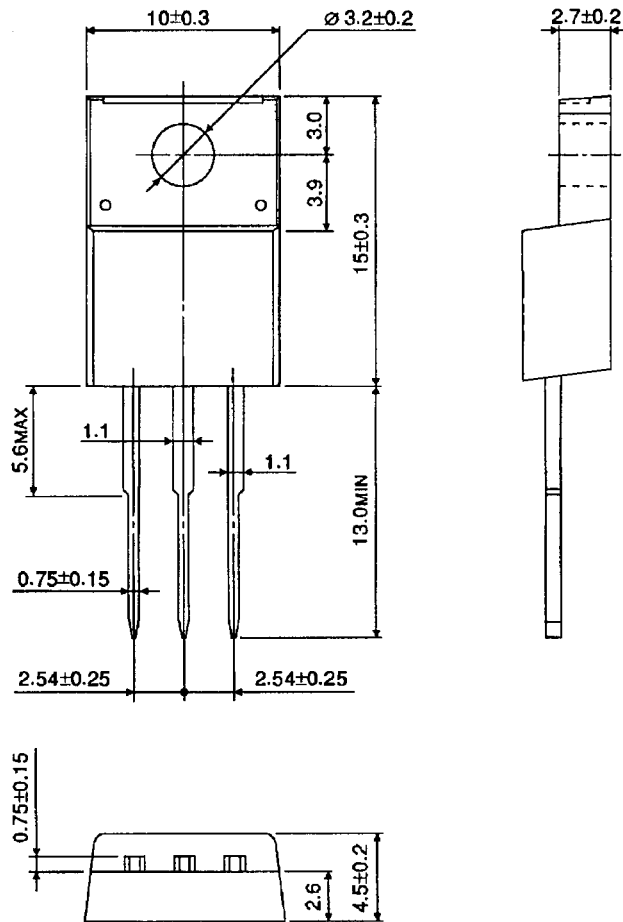

Weight: 1.7 g (typ.)

**RESTRICTIONS ON PRODUCT USE**

000707EBA

- TOSHIBA is continually working to improve the quality and reliability of its products. Nevertheless, semiconductor devices in general can malfunction or fail due to their inherent electrical sensitivity and vulnerability to physical stress. It is the responsibility of the buyer, when utilizing TOSHIBA products, to comply with the standards of safety in making a safe design for the entire system, and to avoid situations in which a malfunction or failure of such TOSHIBA products could cause loss of human life, bodily injury or damage to property.  
In developing your designs, please ensure that TOSHIBA products are used within specified operating ranges as set forth in the most recent TOSHIBA products specifications. Also, please keep in mind the precautions and conditions set forth in the "Handling Guide for Semiconductor Devices," or "TOSHIBA Semiconductor Reliability Handbook" etc..
- The TOSHIBA products listed in this document are intended for usage in general electronics applications (computer, personal equipment, office equipment, measuring equipment, industrial robotics, domestic appliances, etc.). These TOSHIBA products are neither intended nor warranted for usage in equipment that requires extraordinarily high quality and/or reliability or a malfunction or failure of which may cause loss of human life or bodily injury ("Unintended Usage"). Unintended Usage include atomic energy control instruments, airplane or spaceship instruments, transportation instruments, traffic signal instruments, combustion control instruments, medical instruments, all types of safety devices, etc.. Unintended Usage of TOSHIBA products listed in this document shall be made at the customer's own risk.
- The products described in this document are subject to the foreign exchange and foreign trade laws.
- The information contained herein is presented only as a guide for the applications of our products. No responsibility is assumed by TOSHIBA CORPORATION for any infringements of intellectual property or other rights of the third parties which may result from its use. No license is granted by implication or otherwise under any intellectual property or other rights of TOSHIBA CORPORATION or others.
- The information contained herein is subject to change without notice.