

SN54122, SN54123, SN54130, SN54LS122, SN54LS123, SN74122, SN74123, SN74130, SN74LS122, SN74LS123 RETRIGGERABLE MONOSTABLE MULTIVIBRATORS

SDLS043 - DECEMBER 1983 - REVISED MARCH 1988

- D-C Triggered from Active-High or Active-Low Gated Logic Inputs
- Retriggerable for Very Long Output Pulses, Up to 100% Duty Cycle
- Overriding Clear Terminates Output Pulse
- '122 and 'LS122 Have Internal Timing Resistors

description

These d-c triggered multivibrators feature output pulse-duration control by three methods. The basic pulse time is programmed by selection of external resistance and capacitance values (see typical application data). The '122 and 'LS122 have internal timing resistors that allow the circuits to be used with only an external capacitor, if so desired. Once triggered, the basic pulse duration may be extended by retriggering the gated low-level-active (A) or high-level-active (B) inputs, or be reduced by use of the overriding clear. Figure 1 illustrates pulse control by retriggering and early clear.

The 'LS122 and 'LS123 are provided enough Schmitt hysteresis to ensure jitter-free triggering from the B input with transition rates as slow as 0.1 millivolt per nanosecond.

The R_{int} is nominal 10 k Ω for '122 and 'LS122.

SN54123, SN54130, SN54LS123 . . . J OR W PACKAGE
SN74123, SN74130 . . . N PACKAGE
SN74LS123 . . . D OR N PACKAGE
(TOP VIEW) (SEE NOTES 1 THRU 4)



SN54LS122 . . . FK PACKAGE
(TOP VIEW) (SEE NOTES 1 THRU 4)



SN54122, SN54LS122 . . . J OR W PACKAGE
SN74122 . . . N PACKAGE
SN74LS122 . . . D OR N PACKAGE
(TOP VIEW) (SEE NOTES 1 THRU 4)



- NOTES: 1. An external timing capacitor may be connected between C_{ext} and R_{ext}/C_{ext} (positive).
2. To use the internal timing resistor of '122 or 'LS122, connect R_{int} to V_{CC} .
3. For improved pulse duration accuracy and repeatability, connect an external resistor between R_{ext}/C_{ext} and V_{CC} with R_{int} open-circuited.
4. To obtain variable pulse durations, connect an external variable resistance between R_{int} or R_{ext}/C_{ext} and V_{CC} .

SN54LS123 . . . FK PACKAGE
(TOP VIEW) (SEE NOTES 1 THRU 4)



NC - No internal connection

PRODUCTION DATA information is current as of publication date. Products conform to specifications per the terms of Texas Instruments standard warranty. Production processing does not necessarily include testing of all parameters.

 **TEXAS
INSTRUMENTS**

POST OFFICE BOX 655303 • DALLAS, TEXAS 75265

**SN54122, SN54123, SN54130, SN54LS122, SN54LS123,
SN74122, SN74123, SN74130, SN74LS122, SN74LS123
RETRIGGERABLE MONOSTABLE MULTIVIBRATORS**

SDLS043 – DECEMBER 1983 – REVISED MARCH 1988

description (continued)

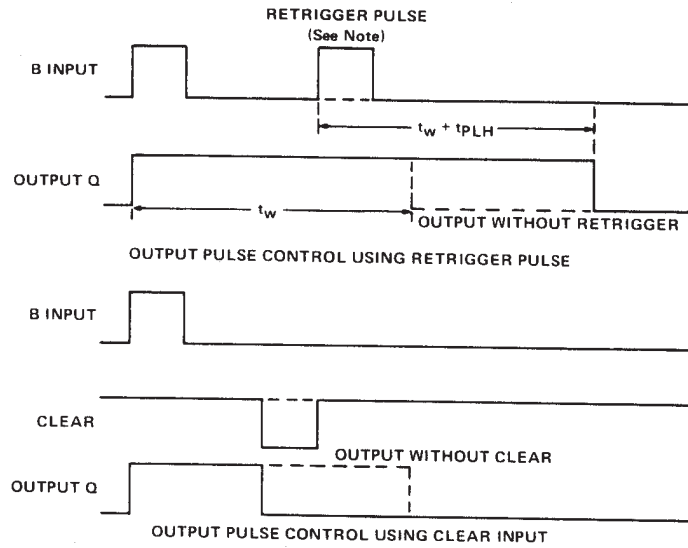

NOTE: Retrigger pulses starting before $0.22 C_{ext}$ (in picoseconds) nanoseconds after the initial trigger pulse will be ignored and the output duration will remain unchanged.

FIGURE 1—TYPICAL INPUT/OUTPUT PULSES

'122, 'LS122
FUNCTION TABLE

CLEAR	INPUTS				OUTPUTS	
	A1	A2	B1	B2	Q	\bar{Q}
L	X	X	X	X	L	H
X	H	H	X	X	L [†]	H [†]
X	X	X	L	X	L [†]	H [†]
X	X	X	X	L	L [†]	H [†]
H	L	X	↑	H	\square	\sqcup
H	L	X	H	↑	\square	\sqcup
H	X	L	↑	H	\square	\sqcup
H	X	L	H	↑	\square	\sqcup
H	H	↓	H	H	\square	\sqcup
H	↓	↓	H	H	\square	\sqcup
H	↓	H	H	H	\square	\sqcup
↑	L	X	H	H	\square	\sqcup
↑	X	L	H	H	\square	\sqcup

'123, '130, 'LS123
FUNCTION TABLE

CLEAR	INPUTS		OUTPUTS	
	A	B	Q	\bar{Q}
L	X	X	L	H
X	H	X	L [†]	H [†]
X	X	L	L [†]	H [†]
H	L	↑	\square	\sqcup
H	↓	H	\square	\sqcup
↑	L	H	\square	\sqcup

See explanation of function tables on page

† These lines of the functional tables assume that the indicated steady-state conditions at the A and B inputs have been set up long enough to complete any pulse started before the set up.



SN54122, SN54123, SN54130, SN54LS122, SN54LS123,
 SN74122, SN74123, SN74130, SN74LS122, SN74LS123
 RETRIGGERABLE MONOSTABLE MULTIVIBRATORS

SDLS043 - DECEMBER 1983 - REVISED MARCH 1988

logic diagram (positive logic)

logic symbol†



R_{int} is nominally 10 k Ω for '122 and 'LS122

logic diagram (positive logic) (each multivibrator)

logic symbol†



Pin numbers shown are for D, J, N, and W packages.

†These symbols are in accordance with ANSI/IEEE Std 91-1984 and IEC Publication 617-12.

SN54122, SN54123, SN54130, SN54LS122, SN54LS123,
 SN74122, SN74123, SN74130, SN74LS122, SN74LS123
RETRIGGERABLE MONOSTABLE MULTIVIBRATORS

SDLS043 – DECEMBER 1983 – REVISED MARCH 1988

schematics of inputs and outputs

'122, '123, '130 CIRCUITS

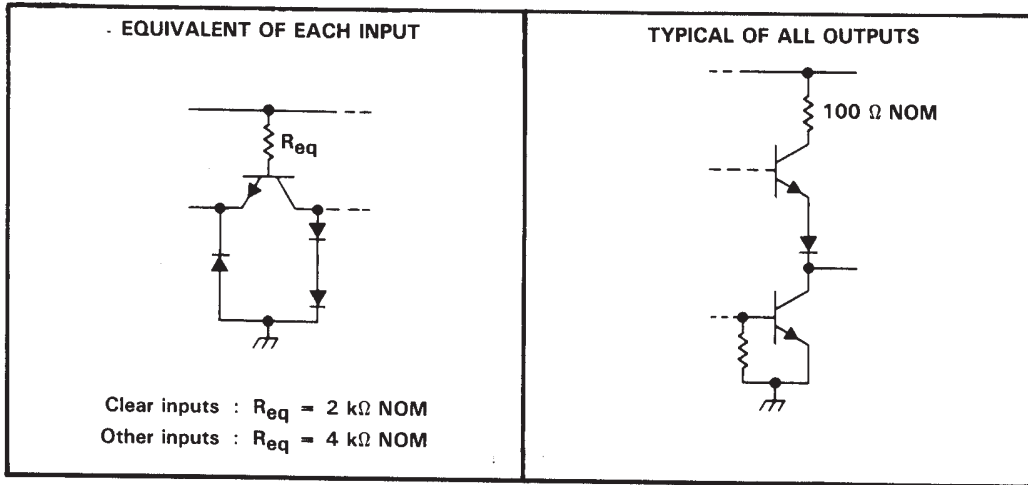

'LS122, 'LS123 CIRCUITS

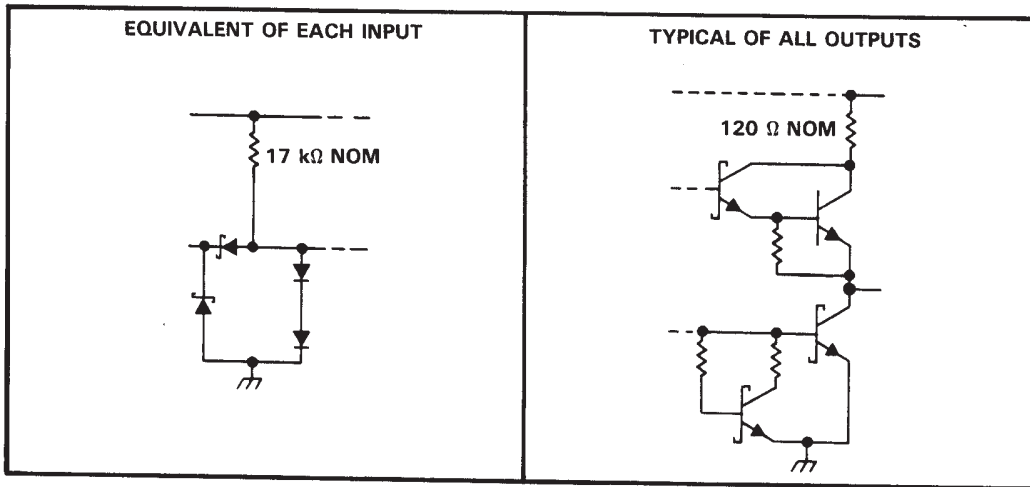

absolute maximum ratings over operating free-air temperature range (unless otherwise noted)

Supply voltage, V_{CC} (see Note 1)	7 V
Input voltage: '122, '123, '130	5.5 V
'LS122, 'LS123	7 V
Operating free-air temperature range: SN54'	-55°C to 125°C
SN74'	0°C to 70°C
Storage temperature range	-65°C to 150°C

NOTE 1: Voltage values are with respect to network ground terminal.

SN54122, SN54123, SN54130, SN74122, SN74123, SN74130 RETRIGGERABLE MONOSTABLE MULTIVIBRATORS

SDLS043 – DECEMBER 1983 – REVISED MARCH 1988

recommended operating conditions

	SN54'			SN74'			UNIT
	MIN	NOM	MAX	MIN	NOM	MAX	
Supply voltage, V_{CC}	4.5	5	5.5	4.75	5	5.25	V
High-level output current, I_{OH}	-800			-800			μ A
Low-level output current, I_{OL}	16			16			mA
Pulse duration, t_w	40			40			ns
External timing resistance, R_{ext}	5			25			50
External capacitance, C_{ext}	No restriction			No restriction			
Wiring capacitance at R_{ext}/C_{ext} terminal	50			50			pF
Operating free-air temperature, T_A	-55			125			0
				70			$^{\circ}$ C

electrical characteristics over recommended free-air operating temperature range (unless otherwise noted)

PARAMETER	TEST CONDITIONS†	'122			'123, '130			UNIT
		MIN	TYP‡	MAX	MIN	TYP‡	MAX	
V_{IH} High-level input voltage		2			2			V
V_{IL} Low-level input voltage		0.8			0.8			V
V_{IK} Input clamp voltage	$V_{CC} = \text{MIN}, I_I = -12 \text{ mA}$	-1.5			-1.5			V
V_{OH} High-level output voltage	$V_{CC} = \text{MIN}, I_{OH} = -800 \mu\text{A}$, See Note 5	2.4	3.4		2.4	3.4		V
V_{OL} Low-level output voltage	$V_{CC} = \text{MIN}, I_{OL} = 16 \text{ mA}$, See Note 5	0.2	0.4		0.2	0.4		V
I_I Input current at maximum input voltage	$V_{CC} = \text{MAX}, V_I = 5.5 \text{ V}$	1			1			mA
I_{IH} High-level input current	Data inputs	40			40			μ A
	Clear input	80			80			
I_{IL} Low-level input current	Data inputs	-1.6			-1.6			mA
	Clear input	-3.2			-3.2			
I_{OS} Short-circuit output current‡	$V_{CC} = \text{MAX}$, See Note 5	-10			-10			mA
I_{CC} Supply current (quiescent or triggered)	$V_{CC} = \text{MAX}$, See Notes 6 and 7	23	36		46	66		mA

† For conditions shown as MIN or MAX, use the appropriate value specified under recommended operating conditions.

‡ All typical values are at $V_{CC} = 5 \text{ V}, T_A = 25^{\circ}\text{C}$.

§ Not more than one output should be shorted at a time.

NOTES: 5. Ground C_{ext} to measure V_{OH} at Q, V_{OL} at \bar{Q} , or I_{OS} at Q. C_{ext} is open to measure V_{OH} at \bar{Q} , V_{OL} at Q, or I_{OS} at \bar{Q} .

6. Quiescent I_{CC} is measured (after clearing) with 4.5 V applied to all clear and A inputs, B inputs grounded, all outputs open and $R_{ext} = 25 \text{ k}\Omega$. R_{int} of '122 is open.

7. I_{CC} is measured in the triggered state with 2.4 V applied to all clear and B inputs, A inputs grounded, all outputs open, $C_{ext} = 0.02 \mu\text{F}$, and $R_{ext} = 25 \text{ k}\Omega$. R_{int} of '122 is open.

switching characteristics, $V_{CC} = 5 \text{ V}, T_A = 25^{\circ}\text{C}$, see note 8

PARAMETER¶	FROM (INPUT)	TO (OUTPUT)	TEST CONDITIONS	'122, '130			'123			UNIT
				MIN	TYP	MAX	MIN	TYP	MAX	
t_{PLH}	A	Q	$C_{ext} = 0, R_{ext} = 5 \text{ k}\Omega,$ $C_L = 15 \text{ pF}, R_L = 400 \Omega$	22	33		22	33	ns	
	B			19	28		19	28		
t_{PHL}	A	\bar{Q}		30	40		30	40	ns	
	B			27	36		27	36		
t_{PHL}	Clear	Q		18	27		18	27	ns	
t_{PLH}		\bar{Q}		30	40		30	40		
$t_{wQ}(\text{min})$	A or B	Q		45	65		45	76	ns	
t_{wQ}	A or B	Q		3.08	3.42	3.76	2.76	3.03	3.37	μ s

¶ t_{PLH} = propagation delay time, low-to-high-level output

t_{PHL} = propagation delay time, high-to-low-level output

t_{wQ} = duration of pulse at output Q.

NOTE 8: Load circuits and voltage waveforms are shown in Section 1.



SN54LS122, SN54LS123, SN74LS122, SN74LS123 RETRIGGERABLE MONOSTABLE MULTIVIBRATORS

SDLS043 – DECEMBER 1983 – REVISED MARCH 1988

recommended operating conditions

	SN54LS'			SN74LS'			UNIT
	MIN	NOM	MAX	MIN	NOM	MAX	
Supply voltage, V_{CC}	4.5	5	5.5	4.75	5	5.25	V
High-level output current, I_{OH}			-400			-400	μ A
Low-level output current, I_{OL}			4			8	mA
Pulse duration, t_w	40			40			ns
External timing resistance, R_{ext}	5		180	5		260	k Ω
External capacitance, C_{ext}	No restriction			No restriction			
Wiring capacitance at R_{ext}/C_{ext} terminal			50			50	pF
Operating free-air temperature, T_A	-55		125	0		70	$^{\circ}$ C

electrical characteristics over recommended operating free-air temperature range (unless otherwise noted)

PARAMETER	TEST CONDITIONS†	SN54LS'			SN74LS'			UNIT
		MIN	TYP‡	MAX	MIN	TYP‡	MAX	
V_{IH} High-level input voltage		2			2			V
V_{IL} Low-level input voltage				0.7			0.8	V
V_{IK} Input clamp voltage	$V_{CC} = \text{MIN}, I_I = -18 \text{ mA}$			-1.5			-1.5	V
V_{OH} High-level output voltage	$V_{CC} = \text{MIN}, V_{IL} = V_{IL \text{ max}}, I_{OH} = -400 \mu\text{A}$	2.5	3.5		2.7	3.5		V
V_{OL} Low-level output voltage	$V_{CC} = \text{MIN}, V_{IH} = 2 \text{ V}, V_{IL} = V_{IL \text{ max}}$			0.25	0.4	0.25	0.4	V
						0.35	0.5	
I_I Input current at maximum input voltage	$V_{CC} = \text{MAX}, V_I = 7 \text{ V}$			0.1			0.1	mA
I_{IH} High-level input current	$V_{CC} = \text{MAX}, V_I = 2.7 \text{ V}$			20			20	μ A
I_{IL} Low-level input current	$V_{CC} = \text{MAX}, V_I = 0.4 \text{ V}$			-0.4			-0.4	mA
I_{OS} Short-circuit output current§	$V_{CC} = \text{MAX}$	-20		-100	-20		-100	mA
I_{CC} Supply current (quiescent or triggered)	$V_{CC} = \text{MAX},$ See Note 13			6	11	6	11	mA
				12	20	12	20	

†For conditions shown as MIN or MAX, use the appropriate value specified under recommended operating conditions.

‡All typical values are at $V_{CC} = 5 \text{ V}, T_A = 25^{\circ}\text{C}$.

§Not more than one output should be shorted at a time and duration of the short-circuit should not exceed one second.

NOTES: 12. To measure V_{OH} at Q, V_{OL} at Q, or I_{OS} at Q, ground R_{ext}/C_{ext} , apply 2 V to B and clear, and pulse A from 2 V to 0 V.
13. With all outputs open and 4.5 V applied to all data and clear inputs. I_{CC} is measured after a momentary ground, then 4.5 V, is applied to A or B inputs.

switching characteristics, $V_{CC} = 5 \text{ V}, T_A = 25^{\circ}\text{C}$ (see note 8)

PARAMETER¶	FROM (INPUT)	TO (OUTPUT)	TEST CONDITIONS	MIN	TYP	MAX	UNIT	
t_{PLH}	A	Q	$C_{ext} = 0, R_{ext} = 5 \text{ k}\Omega, C_L = 15 \text{ pF}, R_L = 2 \text{ k}\Omega$	23	33		ns	
	B			23	44			
t_{PHL}	A	\bar{Q}		32	45		ns	
	B			34	56			
t_{PHL}	Clear	Q		20	27		ns	
t_{PLH}		\bar{Q}		28	45			
$t_{wQ}(\text{min})$	A or B	Q			116	200		ns
t_{wQ}	A or B	Q		$C_{ext} = 1000 \text{ pF}, C_L = 15 \text{ pF}, R_{ext} = 10 \text{ k}\Omega, R_L = 2 \text{ k}\Omega$	4	4.5	5	μ s

¶ t_{PLH} = propagation delay time, low-to-high-level output

t_{PHL} = propagation delay time, high-to-low-level output

t_{wQ} = duration of pulse at output Q.

NOTE 8: Load circuits and voltage waveforms are shown in Section 1.



SN54122, SN54123, SN54130, SN74122, SN74123, SN74130 RETRIGGERABLE MONOSTABLE MULTIVIBRATORS

SDLS043 – DECEMBER 1983 – REVISED MARCH 1988

TYPICAL APPLICATION DATA FOR '122, '123, '130

For pulse durations when $C_{ext} \leq 1000$ pF, see Figure 4.

The output pulse duration is primarily a function of the external capacitor and resistor. For $C_{ext} > 1000$ pF, the output pulse duration (t_w) is defined as:

$$t_w = K \cdot R_T \cdot C_{ext} \left(1 + \frac{0.7}{R_T} \right)$$

where

K is 0.32 for '122, 0.28 for '123 and '130

R_T is in $k\Omega$ (internal or external timing resistance.)

C_{ext} is in pF

t_w is in ns

To prevent reverse voltage across C_{ext} , it is recommended that the method shown in Figure 2 be employed when using electrolytic capacitors and in applications utilizing the clear function. In all applications using the diode, the pulse duration is:

$$t_w = K_D \cdot R_T \cdot C_{ext} \left(1 + \frac{0.7}{R_T} \right)$$

K_D is 0.28 for '122, 0.25 for '123 and '130

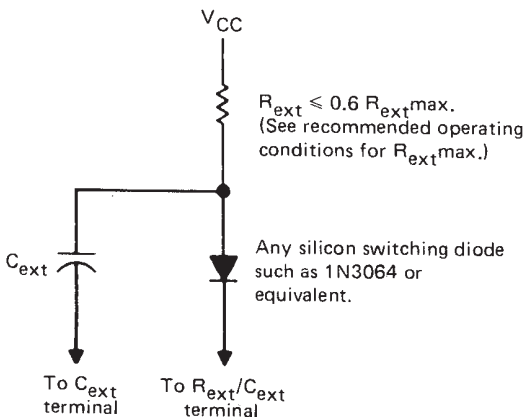

TIMING COMPONENT CONNECTIONS WHEN $C_{ext} > 1000$ pF AND CLEAR IS USED

FIGURE 2

Applications requiring more precise pulse durations (up to 28 seconds) and not requiring the clear feature can best be satisfied with the '121.

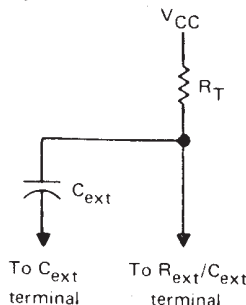

TIMING COMPONENT CONNECTIONS
FIGURE 3

TYPICAL OUTPUT PULSE DURATION vs EXTERNAL TIMING CAPACITANCE



FIGURE 4

†These values of resistance exceed the maximum recommended for use over the full temperature range of the SN54' circuits.

SN54LS122, SN54LS123, SN74LS122, SN74LS123 RETRIGGERABLE MONOSTABLE MULTIVIBRATORS

SDLS043 – DECEMBER 1983 – REVISED MARCH 1988

TYPICAL APPLICATION DATA FOR 'LS122, 'LS123

The basic output pulse duration is essentially determined by the values of external capacitance and timing resistance. For pulse durations when $C_{ext} \leq 1000$ pF, use Figure 6, or use Figure 7 where the pulse duration may be defined as:

$$t_w = K \cdot R_T \cdot C_{ext}$$

When $C_{ext} \geq 1 \mu F$, the output pulse width is defined as:

$$t_w = 0.33 \cdot R_T \cdot C_{ext}$$

For the above two equations, as applicable;

- K is multiplier factor, see Figure 7
- R_T is in $k\Omega$ (internal or external timing resistance)
- C_{ext} is in pF
- t_w is in ns

For maximum noise immunity, system ground should be applied to the C_{ext} node, even though the C_{ext} node is already tied to the ground lead internally. Due to the timing scheme used by the 'LS122 and 'LS123, a switching diode is not required to prevent reverse biasing when using electrolytic capacitors.

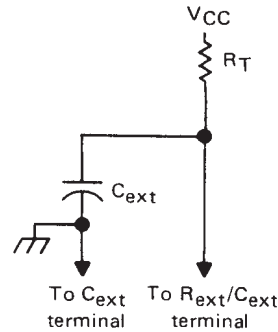

TIMING COMPONENT CONNECTIONS
FIGURE 5

'LS122, 'LS123 TYPICAL OUTPUT PULSE DURATION vs EXTERNAL TIMING CAPACITANCE

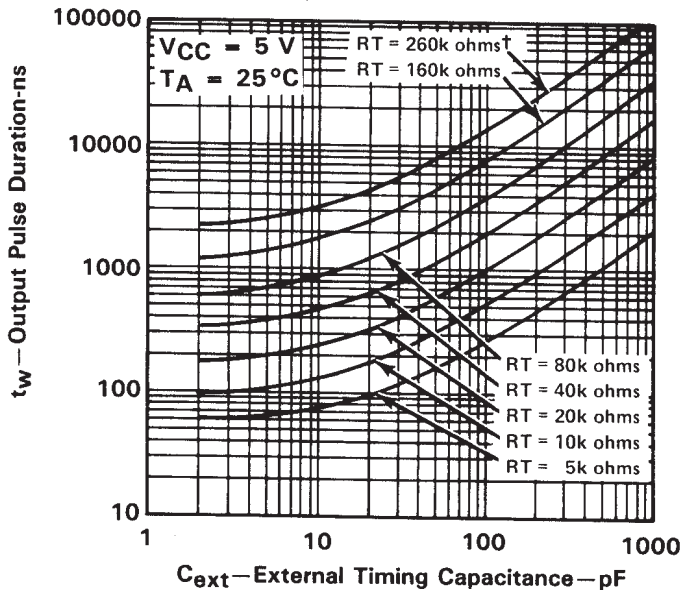

† This value of resistance exceeds the maximum recommended for use over the full temperature range of the SN54LS circuits.

FIGURE 6

SN54LS122, SN54LS123, SN74LS122, SN74LS123 RETRIGGERABLE MONOSTABLE MULTIVIBRATORS

SDLS043 – DECEMBER 1983 – REVISED MARCH 1988

TYPICAL APPLICATION DATA FOR 'LS122, 'LS123†



FIGURE 7

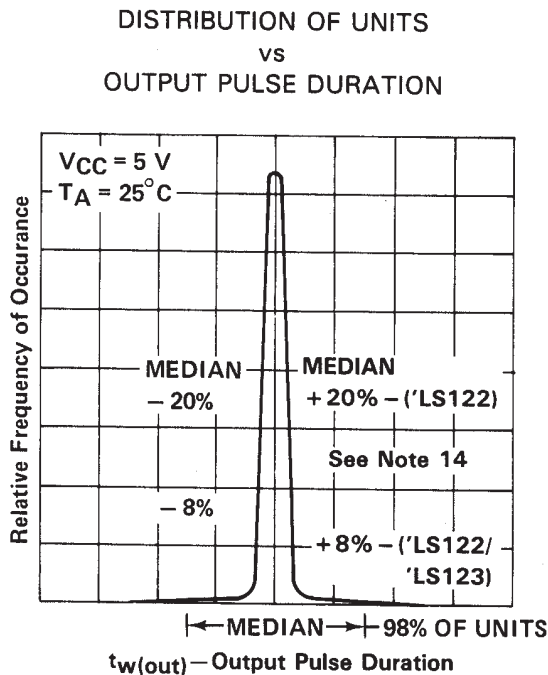

FIGURE 8



FIGURE 9



FIGURE 10

NOTE 14: For the 'LS122, the internal timing resistor, R_{int} was used. For the 'LS122/123, an external timing resistor was used for R_T .
†Data for temperatures below $0^\circ C$ and above $70^\circ C$ and for supply voltages below 4.75 V and above 5.25 V are applicable for SN54LS122 and SN54LS123 only.

PACKAGING INFORMATION

Orderable Device	Status ⁽¹⁾	Package Type	Package Drawing	Pins	Package Qty	Eco Plan ⁽²⁾	Lead/Ball Finish	MSL Peak Temp ⁽³⁾
5962-7603901VEA	ACTIVE	CDIP	J	16	1	None	Call TI	Level-NC-NC-NC
5962-7603901VFA	ACTIVE	CFP	W	16	1	None	Call TI	Level-NC-NC-NC
7603901EA	ACTIVE	CDIP	J	16	1	None	Call TI	Level-NC-NC-NC
7603901FA	ACTIVE	CFP	W	16	1	None	Call TI	Level-NC-NC-NC
JM38510/01203BEA	ACTIVE	CDIP	J	16	1	None	Call TI	Level-NC-NC-NC
JM38510/31401B2A	ACTIVE	LCCC	FK	20	1	None	Call TI	Level-NC-NC-NC
JM38510/31401BEA	ACTIVE	CDIP	J	16	1	None	Call TI	Level-NC-NC-NC
JM38510/31401BFA	ACTIVE	CFP	W	16	1	None	Call TI	Level-NC-NC-NC
SN54122J	OBSOLETE	CDIP	J	14		None	Call TI	Call TI
SN54123J	ACTIVE	CDIP	J	16	1	None	Call TI	Level-NC-NC-NC
SN54LS123J	ACTIVE	CDIP	J	16	1	None	Call TI	Level-NC-NC-NC
SN74122N	OBSOLETE	PDIP	N	14		None	Call TI	Call TI
SN74123N	ACTIVE	PDIP	N	16	25	Pb-Free (RoHS)	CU NIPDAU	Level-NC-NC-NC
SN74123N3	OBSOLETE	PDIP	N	16		None	Call TI	Call TI
SN74LS122D	ACTIVE	SOIC	D	14	50	Pb-Free (RoHS)	CU NIPDAU	Level-2-260C-1 YEAR/ Level-1-235C-UNLIM
SN74LS122DR	ACTIVE	SOIC	D	14	2500	Pb-Free (RoHS)	CU NIPDAU	Level-2-260C-1 YEAR/ Level-1-235C-UNLIM
SN74LS122N	ACTIVE	PDIP	N	14	25	Pb-Free (RoHS)	CU NIPDAU	Level-NC-NC-NC
SN74LS122N3	OBSOLETE	PDIP	N	14		None	Call TI	Call TI
SN74LS122NSR	ACTIVE	SO	NS	14	2000	Pb-Free (RoHS)	CU NIPDAU	Level-2-260C-1 YEAR/ Level-1-235C-UNLIM
SN74LS123D	ACTIVE	SOIC	D	16	40	Pb-Free (RoHS)	CU NIPDAU	Level-2-260C-1 YEAR/ Level-1-235C-UNLIM
SN74LS123DR	ACTIVE	SOIC	D	16	2500	Pb-Free (RoHS)	CU NIPDAU	Level-2-260C-1 YEAR/ Level-1-235C-UNLIM
SN74LS123J	OBSOLETE	CDIP	J	16		None	Call TI	Call TI
SN74LS123N	ACTIVE	PDIP	N	16	25	Pb-Free (RoHS)	CU NIPDAU	Level-NC-NC-NC
SN74LS123N3	OBSOLETE	PDIP	N	16		None	Call TI	Call TI
SN74LS123NSR	ACTIVE	SO	NS	16	2000	Pb-Free (RoHS)	CU NIPDAU	Level-2-260C-1 YEAR/ Level-1-235C-UNLIM
SNJ54122J	OBSOLETE	CDIP	J	14		None	Call TI	Call TI
SNJ54123J	ACTIVE	CDIP	J	16	1	None	Call TI	Level-NC-NC-NC
SNJ54123W	ACTIVE	CFP	W	16	1	None	Call TI	Level-NC-NC-NC
SNJ54LS123FK	ACTIVE	LCCC	FK	20	1	None	Call TI	Level-NC-NC-NC
SNJ54LS123J	ACTIVE	CDIP	J	16	1	None	Call TI	Level-NC-NC-NC
SNJ54LS123W	ACTIVE	CFP	W	16	1	None	Call TI	Level-NC-NC-NC

⁽¹⁾ The marketing status values are defined as follows:

ACTIVE: Product device recommended for new designs.

LIFEBUY: TI has announced that the device will be discontinued, and a lifetime-buy period is in effect.

NRND: Not recommended for new designs. Device is in production to support existing customers, but TI does not recommend using this part in a new design.

PREVIEW: Device has been announced but is not in production. Samples may or may not be available.

OBSOLETE: TI has discontinued the production of the device.

⁽²⁾ Eco Plan - May not be currently available - please check <http://www.ti.com/productcontent> for the latest availability information and additional product content details.

None: Not yet available Lead (Pb-Free).

Pb-Free (RoHS): TI's terms "Lead-Free" or "Pb-Free" mean semiconductor products that are compatible with the current RoHS requirements for all 6 substances, including the requirement that lead not exceed 0.1% by weight in homogeneous materials. Where designed to be soldered at high temperatures, TI Pb-Free products are suitable for use in specified lead-free processes.

Green (RoHS & no Sb/Br): TI defines "Green" to mean "Pb-Free" and in addition, uses package materials that do not contain halogens, including bromine (Br) or antimony (Sb) above 0.1% of total product weight.

⁽³⁾ MSL, Peak Temp. -- The Moisture Sensitivity Level rating according to the JEDEC industry standard classifications, and peak solder temperature.

Important Information and Disclaimer: The information provided on this page represents TI's knowledge and belief as of the date that it is provided. TI bases its knowledge and belief on information provided by third parties, and makes no representation or warranty as to the accuracy of such information. Efforts are underway to better integrate information from third parties. TI has taken and continues to take reasonable steps to provide representative and accurate information but may not have conducted destructive testing or chemical analysis on incoming materials and chemicals. TI and TI suppliers consider certain information to be proprietary, and thus CAS numbers and other limited information may not be available for release.

In no event shall TI's liability arising out of such information exceed the total purchase price of the TI part(s) at issue in this document sold by TI to Customer on an annual basis.

IMPORTANT NOTICE

Texas Instruments Incorporated and its subsidiaries (TI) reserve the right to make corrections, modifications, enhancements, improvements, and other changes to its products and services at any time and to discontinue any product or service without notice. Customers should obtain the latest relevant information before placing orders and should verify that such information is current and complete. All products are sold subject to TI's terms and conditions of sale supplied at the time of order acknowledgment.

TI warrants performance of its hardware products to the specifications applicable at the time of sale in accordance with TI's standard warranty. Testing and other quality control techniques are used to the extent TI deems necessary to support this warranty. Except where mandated by government requirements, testing of all parameters of each product is not necessarily performed.

TI assumes no liability for applications assistance or customer product design. Customers are responsible for their products and applications using TI components. To minimize the risks associated with customer products and applications, customers should provide adequate design and operating safeguards.

TI does not warrant or represent that any license, either express or implied, is granted under any TI patent right, copyright, mask work right, or other TI intellectual property right relating to any combination, machine, or process in which TI products or services are used. Information published by TI regarding third-party products or services does not constitute a license from TI to use such products or services or a warranty or endorsement thereof. Use of such information may require a license from a third party under the patents or other intellectual property of the third party, or a license from TI under the patents or other intellectual property of TI.

Reproduction of information in TI data books or data sheets is permissible only if reproduction is without alteration and is accompanied by all associated warranties, conditions, limitations, and notices. Reproduction of this information with alteration is an unfair and deceptive business practice. TI is not responsible or liable for such altered documentation.

Resale of TI products or services with statements different from or beyond the parameters stated by TI for that product or service voids all express and any implied warranties for the associated TI product or service and is an unfair and deceptive business practice. TI is not responsible or liable for any such statements.

Following are URLs where you can obtain information on other Texas Instruments products and application solutions:

Products		Applications	
Amplifiers	amplifier.ti.com	Audio	www.ti.com/audio
Data Converters	dataconverter.ti.com	Automotive	www.ti.com/automotive
DSP	dsp.ti.com	Broadband	www.ti.com/broadband
Interface	interface.ti.com	Digital Control	www.ti.com/digitalcontrol
Logic	logic.ti.com	Military	www.ti.com/military
Power Mgmt	power.ti.com	Optical Networking	www.ti.com/opticalnetwork
Microcontrollers	microcontroller.ti.com	Security	www.ti.com/security
		Telephony	www.ti.com/telephony
		Video & Imaging	www.ti.com/video
		Wireless	www.ti.com/wireless

Mailing Address: Texas Instruments
Post Office Box 655303 Dallas, Texas 75265