

# M5224P/FP

## QUAD SINGLE POWER SUPPLY OPERATIONAL AMPLIFIERS

### DESCRIPTION

The M5224 are semiconductor integrated circuits designed as quad operational amplifiers in which single power supply operation is possible.

The devices come in a standard 14-pin DIP, FP and contain four circuits for yielding a high internal phase compensation and high performance. For both input and output, operation is possible from the GND level and this makes it possible for the device to be used widely as a general-purpose operational amplifier in the motor control circuits of such equipment as cassette decks, turntables, VTRs, and digital audio disc players as well as in automotive electronic products and communications equipment. It can be also employed as a simple comparator.

### PIN CONFIGURATION (TOP VIEW)

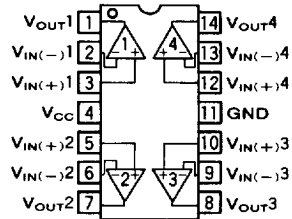

Outline 14P4 (P)  
14P2S-A (FP)

### FEATURES

- Wide common input voltage range and operation permitted with GND level input .....  $V_i = -0.3V \sim +36V$
- Output voltage level can be reduced to near the GND level
- Wide operating supply voltage range and single power supply operation possible .....  $V_{CC} = 3V \sim +36V (V_{CCmax})$
- High voltage gain .....  $G_{VO} = 110dB (typ.)$
- High allowable power dissipation  
.....  $P_d = 700mW (M5224P)$   
.....  $P_d = 550mW (M5224FP)$

### APPLICATION

General-purpose amplifier in control circuits of cassette decks, turntable, VTRs, video disc players and audio disc players; general-purpose amplifier in automotive electronic products, communications equipment and copying machines.

General-purpose amplifier in radio-controlled and electronic toys, and electronic games.

### BLOCK DIAGRAM

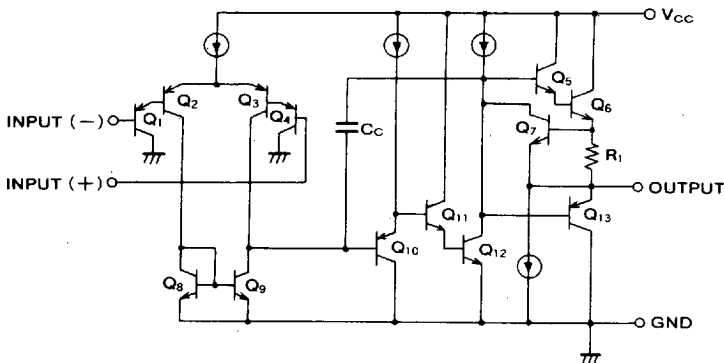

\* Four circuits are featured in the circuit on the left.

6249826 0021547 T61



**QUAD SINGLE POWER SUPPLY OPERATIONAL AMPLIFIERS**

**ABSOLUTE MAXIMUM RATINGS** ( $T_a=25^\circ\text{C}$ , unless otherwise noted)

Symbol	Parameter	Conditions	Ratings	Unit
$V_{CC}$	Supply voltage		36 ( $\pm 18$ )	V
$I_{sink}$	Load current		$\pm 50$	mA
$I_{source}$				mA
$V_{id}$	Differential input voltage		$\pm 36$	V
$V_i$	Input voltage		$-0.3 \sim +36$	V
$P_d$	Power dissipation		700 (DIP)/550 (FP)	mW
$K_\theta$	Thermal derating	$T_a \geq 25^\circ\text{C}$	7 (DIP)/5.5 (FP)	mW/ $^\circ\text{C}$
$T_{opr}$	Ambient temperature		$-20 \sim +75$	$^\circ\text{C}$
$T_{stg}$	Storage temperature		$-55 \sim +125$	$^\circ\text{C}$

**ELECTRICAL CHARACTERISTICS** ( $T_a=25^\circ\text{C}$ ,  $V_{CC}=+15\text{V}$ )

Symbol	Parameter	Test conditions	Limits			Unit
			Min.	Typ.	Max.	
$V_{IO}$	Input offset voltage	$R_S = \infty$		2	7	mV
$I_B$	Input bias current			45	250	nA
$I_{IO}$	Input offset current			5	50	nA
$V_{ICM}$	Common phase input voltage width		0		$V_{CC}-1.5$	V
$I_{CC}$	Circuit current	$R_L = \infty$		1.1	1.5	mA
$G_{VO}$	Open loop voltage gain	$R_L \geq 2\text{k}\Omega$	25	100		V/mV
$V_O$	Output voltage range	$R_L = 2\text{k}\Omega$	0		$V_{CC}-1.5$	V
CMRR	Common phase rejection ratio		65	85		dB
SVRR	Supply voltage rejection ratio		65	100		dB
CSR	Channel separation	$f=1\text{kHz} \sim 20\text{kHz}$			120	dB
$I_{source}$	Output source current	$V_{IN(+)}=1\text{V}, V_{IN(-)}=0\text{V}$	20	40		mA
$I_{sink}$	Output sink current	$V_{IN(-)}=1\text{V}, V_{IN(+)}=0\text{V}$	10	20		mA
		$V_{IN(-)}=1\text{V}, V_{IN(+)}=0\text{V}, V_O=200\text{mV}$	12	50		$\mu\text{A}$

**TYPICAL CHARACTERISTICS**

**THERMAL DERATING (MAXIMUM RATING)**

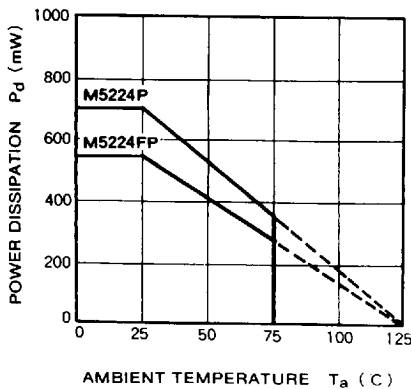

**VOLTAGE GAIN VS. FREQUENCY RESPONSE**

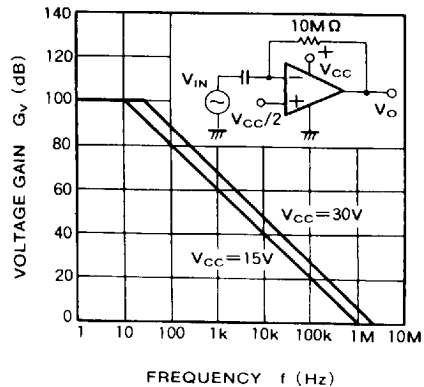

6249826 0021548 9T8



QUAD SINGLE POWER SUPPLY OPERATIONAL AMPLIFIERS

CIRCUIT CURRENT VS. SUPPLY VOLTAGE

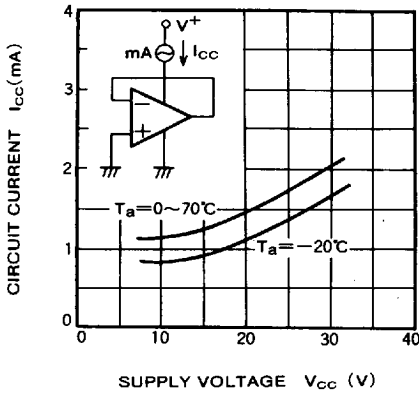

INPUT BIAS CURRENT VS. SUPPLY VOLTAGE

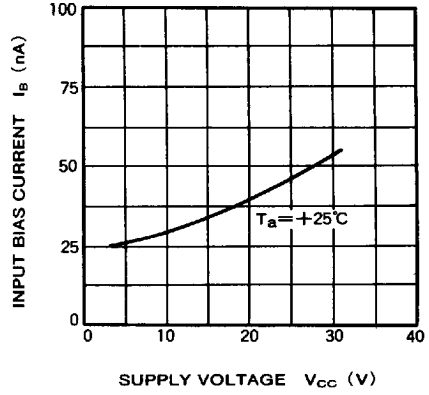

VOLTAGE GAIN VS. SUPPLY VOLTAGE

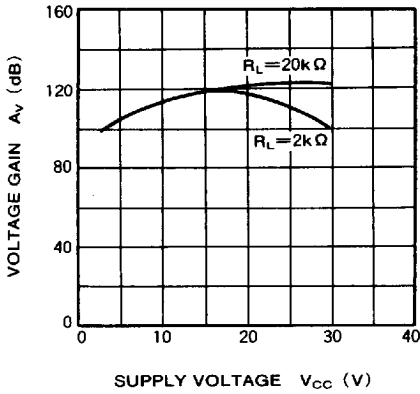

MAXIMUM OUTPUT CURRENT VS. AMBIENT TEMPERATURE

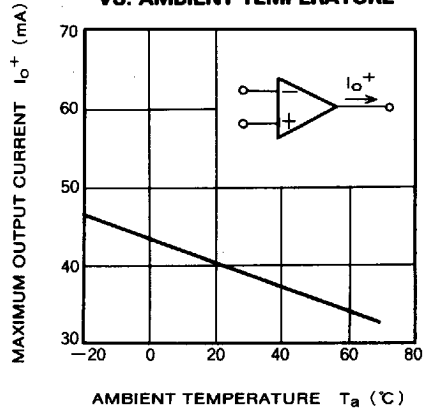

MAXIMUM OUTPUT VOLTAGE VS. FREQUENCY RESPONSE

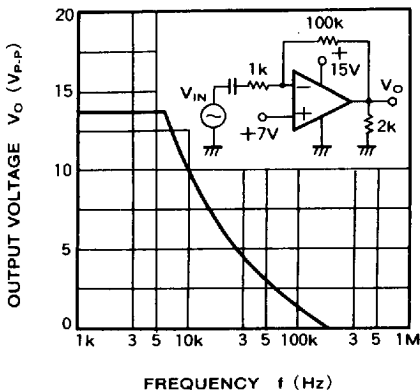

INPUT VOLTAGE / OUTPUT VOLTAGE VS. TIME

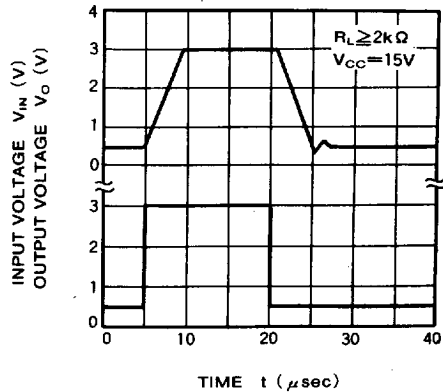

6249826 0021549 834



QUAD SINGLE POWER SUPPLY OPERATIONAL AMPLIFIERS

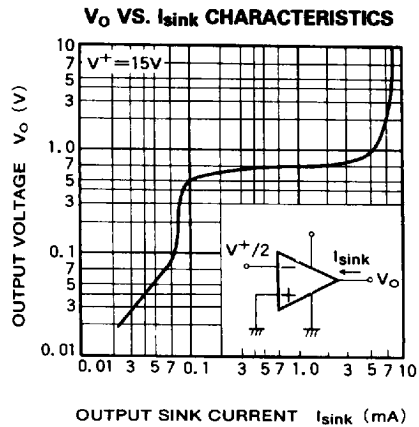
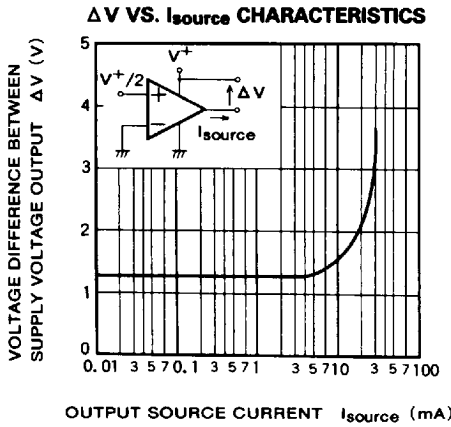

**BASIC OPERATION OF SINGLE POWER SUPPLY OPERATIONAL AMPLIFIER**

The M5224 is an operational amplifier that operates from 0V (GND) level for both input and output if used at a single power supply voltage.

Basic operation of the device is explained in the following, comparing characteristics of the operational amplifier M5218.

**Dual power supply operational amplifier M5218**

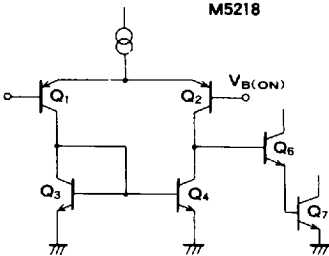

Fig. 1

**Single power supply operational amplifier M5224**

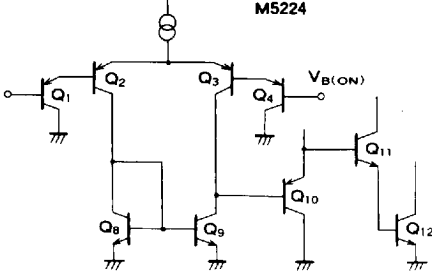

Fig. 2

Fig. 1 illustrates the dual power supply operational amplifier M5218, and Fig. 2 illustrates an input differential circuit of the single power supply operational amplifier M5224. In this case, the input stage base voltage V<sub>B(ON)</sub> for operating an input differential circuit in the M5218 is as follows;

$$V_{B(ON)} = V_{BE7} + V_{BE6} + V_{CE2} - V_{BE2}$$

(If V<sub>BE</sub> ≅ 0.6V, V<sub>CE</sub> ≅ 0.5V)

$$\cong 1.1V$$

and, in the M5224.

$$V_{B(ON)} = V_{BE12} + V_{BE11} - V_{BE10} + V_{CE3} - V_{BE3} - V_{BE4}$$

$$\cong -0.1V$$

and, in the M5224, the differential circuit is activated even when the input level is 0V. The input and output characteristics are shown in Fig. 3.

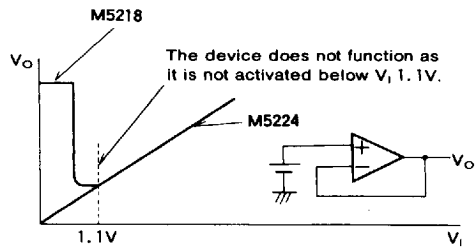

Operation of an output stage is explained in the following.

6249826 0021550 556



QUAD SINGLE POWER SUPPLY OPERATIONAL AMPLIFIERS

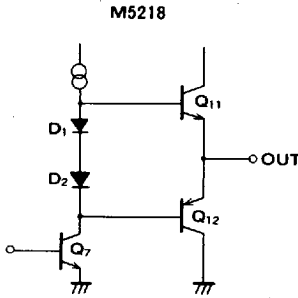

Fig. 4

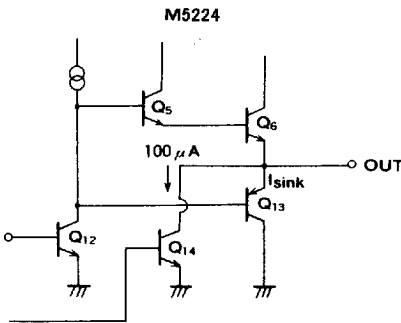

Fig. 5

Fig. 4 illustrates an output stage of the M5218, which adopts an AB-class push-pull circuit of ordinary operational amplifier output type, where no crossover distortion occurs because idling current is running from  $D_1$ ,  $D_2$  bias to  $Q_{11}$ ,  $Q_{12}$  in quiescent state. In this case, the output never goes below the level of  $V_{BE12} + V_{CE7}$ , and the device is activated up to a voltage of approximately 1.1V. Moreover, the voltage changes greatly according to conditions of load current.

Fig. 5 illustrates the M5224, to which a rated current circuit of  $I_C \approx 100 \mu A$  is connected by  $Q_{14}$  and the output can be reduced to near GND level as an A-class bias output stage up to the current of  $100 \mu A$ . For a load in excess of this current, in case of the M5224 driven by  $Q_{13}$ , no idling current is present because of C-class bias (where the base of output transistors  $Q_5$ ,  $Q_6$ ,  $Q_{13}$  are shorted), and crossover distortion occurs. Therefore, the device may not be suitable for audio signal amplifiers.

Both single and dual power supply amplifiers operate exactly with the same operating circuit logic (activation level of input and output and load driving methods are different), but bias must be set at  $V_{CC}/2$  for output DC current in both single and dual power supply amplifiers.

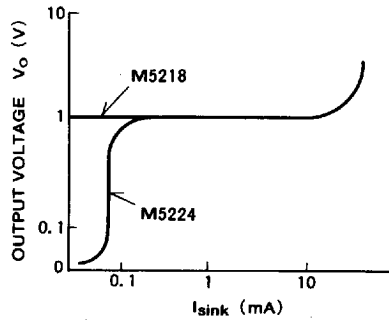

Fig. 6

REDUCTION OF DISTORTION IN A SINGLE POWER SUPPLY OPERATIONAL AMPLIFIER

As has been explained previously, a single power supply operational amplifier operates with low distortion as an A-class bias circuit up to a load condition that can be driven by current ( $100 \mu A$ ) in a rated current circuit which is built in the output stage, and it can be used for audio signals but, if the load condition exceeds the value of current, the device is placed into a C-class bias condition, and crossover distortion occurs. To reduce this distortion, a pull-up resistor (e.g.  $3k \Omega$ ) for running A-class bias current externally can be connected as shown in Fig. 7 to increase the A-class bias current and reduce distortion. (Refer to Fig. 8 DISTORTION VS OUTPUT VOLTAGE.)

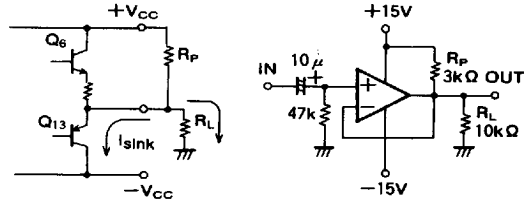

Fig. 7 (Explanation by dual power supply method)

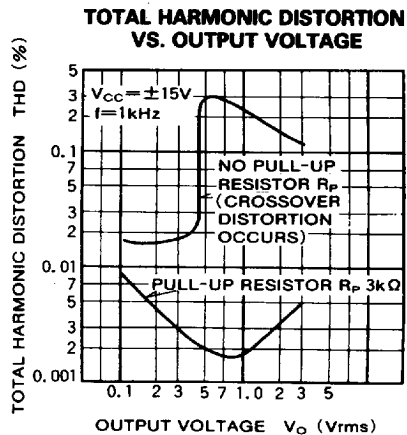

Fig. 8

6249826 0021551 492

