

LM2675 SIMPLE SWITCHER® Power Converter High Efficiency 1A Step-Down Voltage Regulator

General Description

The LM2675 series of regulators are monolithic integrated circuits built with a LMDMOS process. These regulators provide all the active functions for a step-down (buck) switching regulator, capable of driving a 1A load current with excellent line and load regulation. These devices are available in fixed output voltages of 3.3V, 5.0V, 12V, and an adjustable output version.

Requiring a minimum number of external components, these regulators are simple to use and include patented internal frequency compensation (Patent Nos. 5,382,918 and 5,514,947) and a fixed frequency oscillator.

The LM2675 series operates at a switching frequency of 260 kHz, thus allowing smaller sized filter components than what would be needed with lower frequency switching regulators. Because of its very high efficiency (>90%), the copper traces on the printed circuit board are the only heat sinking needed.

A family of standard inductors for use with the LM2675 are available from several different manufacturers. This feature greatly simplifies the design of switch-mode power supplies using these advanced ICs. Also included in the datasheet are selector guides for diodes and capacitors designed to work in switch-mode power supplies.

Other features include a guaranteed $\pm 1.5\%$ tolerance on output voltage within specified input voltages and output load conditions, and $\pm 10\%$ on the oscillator frequency. External shutdown is included, featuring typically 50 μA stand-by current. The output switch includes current limiting, as well as thermal shutdown for full protection under fault conditions.

To simplify the LM2675 buck regulator design procedure, there exists computer design software, *LM267X Made Simple* version 6.0.

Features

- Efficiency up to 96%
- Available in SO-8, 8-pin DIP and LLP packages
- Computer Design Software *LM267X Made Simple* (version 6.0)
- Simple and easy to design with
- Requires only 5 external components
- Uses readily available standard inductors
- 3.3V, 5.0V, 12V, and adjustable output versions
- Adjustable version output voltage range: 1.21V to 37V
- $\pm 1.5\%$ max output voltage tolerance over line and load conditions
- Guaranteed 1A output load current
- 0.25 Ω DMOS Output Switch
- Wide input voltage range: 8V to 40V
- 260 kHz fixed frequency internal oscillator
- TTL shutdown capability, low power standby mode
- Thermal shutdown and current limit protection

Typical Applications

- Simple High Efficiency (>90%) Step-Down (Buck) Regulator
- Efficient Pre-Regulator for Linear Regulators
- Positive-to-Negative Converter

Typical Application

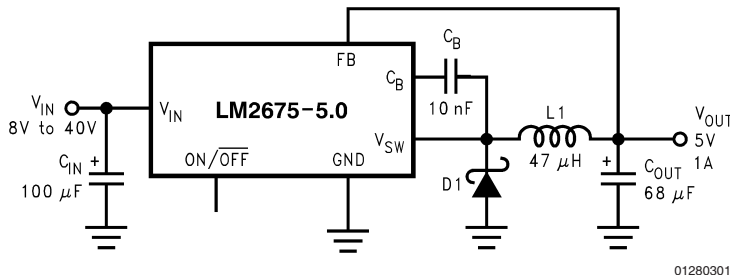

SIMPLE SWITCHER® is a registered trademark of National Semiconductor Corporation.
Windows® is a registered trademark of Microsoft Corporation.

Connection Diagrams

16-Lead LLP Surface Mount Package
Top View

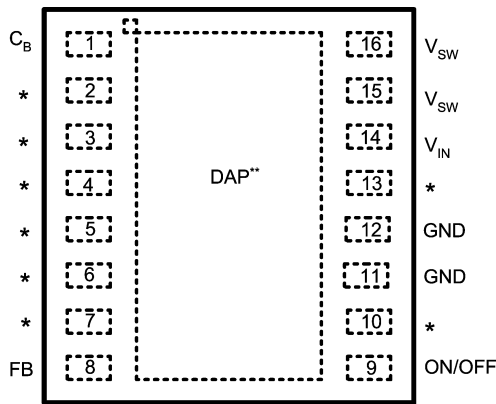

* No Connections

**Connect to Pins 11, 12 on PCB

01280338

LLP Package

See NSC Package Drawing Number LDA16A

8-Lead Package
Top View

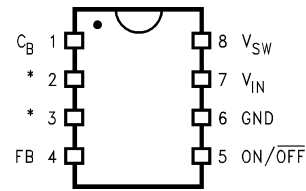

01280302

SO-8/DIP Package

See NSC Package Drawing Number MO8A/N08E

Package Marking and Ordering Information

TABLE 1.

| Output Voltage | Order Information | Package Marking | Supplied as: |
|--------------------|-------------------|-----------------|------------------------------|
| 16 Lead LLP | | | |
| 12 | LM2675LD-12 | S000DB | 1000 Units on Tape and Reel |
| 12 | LM2675LDX-12 | S000DB | 4500 Units on Tape and Reel |
| 3.3 | LM2675LD-3.3 | S000EB | 1000 Units on Tape and Reel |
| 3.3 | LM2675LDX-3.3 | S000EB | 4500 Units on Tape and Reel |
| 5.0 | LM2675LD-5.0 | S000FB | 1000 Units on Tape and Reel |
| 5.0 | LM2675LDX-5.0 | S000FB | 4500 Units on Tape and Reel |
| ADJ | LM2675LD-ADJ | S000GB | 1000 Units on Tape and Reel |
| ADJ | LM2675LDX-ADJ | S000GB | 4500 Units on Tape and Reel |
| SO-8 | | | |
| 12 | LM2675M-12 | 2675M-12 | Shipped in Anti-Static Rails |
| 12 | LM2675MX-12 | 2675M-12 | 2500 Units on Tape and Reel |
| 3.3 | LM2675M-3.3 | 2675M-3.3 | Shipped in Anti-Static Rails |
| 3.3 | LM2675MX-3.3 | 2675M-3.3 | 2500 Units on Tape and Reel |
| 5.0 | LM2675M-5.0 | 2675M-5.0 | Shipped in Anti-Static Rails |
| 5.0 | LM2675MX-5.0 | 2675M-5.0 | 2500 Units on Tape and Reel |
| ADJ | LM2675M-ADJ | 2675M-ADJ | Shipped in Anti-Static Rails |
| ADJ | LM2675MX-ADJ | 2675M-ADJ | 2500 Units on Tape and Reel |
| DIP | | | |
| 12 | LM2675N-12 | LM2675N-12 | Shipped in Anti-Static Rails |
| 3.3 | LM2675N-3.3 | LM2675N-3.3 | Shipped in Anti-Static Rails |
| 5.0 | LM2675N-5.0 | LM2675N-5.0 | Shipped in Anti-Static Rails |
| ADJ | LM2675N-ADJ | LM2675N-ADJ | Shipped in Anti-Static Rails |

Absolute Maximum Ratings (Note 1)

If Military/Aerospace specified devices are required, please contact the National Semiconductor Sales Office/Distributors for availability and specifications.

| | | | |
|---------------------------|------------------------------|------------------------------|-----------------|
| Supply Voltage | 45V | Storage Temperature Range | -65°C to +150°C |
| ON/OFF Pin Voltage | $-0.1V \leq V_{SH} \leq 6V$ | Lead Temperature | |
| Switch Voltage to Ground | -1V | M Package | |
| Boost Pin Voltage | $V_{SW} + 8V$ | Vapor Phase (60s) | +215°C |
| Feedback Pin Voltage | $-0.3V \leq V_{FB} \leq 14V$ | Infrared (15s) | +220°C |
| ESD Susceptibility | | N Package (Soldering, 10s) | +260°C |
| Human Body Model (Note 2) | 2 kV | LLP Package (See AN-1187) | |
| Power Dissipation | Internally Limited | Maximum Junction Temperature | +150°C |

Operating Ratings

| | | | |
|----------------|-------------|----------------------------|--|
| Supply Voltage | 6.5V to 40V | Junction Temperature Range | $-40^\circ\text{C} \leq T_J \leq +125^\circ\text{C}$ |
|----------------|-------------|----------------------------|--|

Electrical Characteristics

LM2675-3.3 Specifications with standard type face are for $T_J = 25^\circ\text{C}$, and those with **bold type face** apply over full Operating Temperature Range.

| Symbol | Parameter | Conditions | Typical (Note 4) | Min (Note 5) | Max (Note 5) | Units |
|--|----------------|--|---------------------|---------------------|---------------------|-------|
| SYSTEM PARAMETERS Test Circuit <i>Figure 2</i> (Note 3) | | | | | | |
| V_{OUT} | Output Voltage | $V_{IN} = 8V$ to 40V, $I_{LOAD} = 20$ mA to 1A | 3.3 | 3.251/ 3.201 | 3.350/ 3.399 | V |
| V_{OUT} | Output Voltage | $V_{IN} = 6.5V$ to 40V, $I_{LOAD} = 20$ mA to 500 mA | 3.3 | 3.251/ 3.201 | 3.350/ 3.399 | V |
| η | Efficiency | $V_{IN} = 12V$, $I_{LOAD} = 1A$ | 86 | | | % |

LM2675-5.0

| Symbol | Parameter | Conditions | Typical (Note 4) | Min (Note 5) | Max (Note 5) | Units |
|--|----------------|--|---------------------|---------------------|---------------------|-------|
| SYSTEM PARAMETERS Test Circuit <i>Figure 2</i> (Note 3) | | | | | | |
| V_{OUT} | Output Voltage | $V_{IN} = 8V$ to 40V, $I_{LOAD} = 20$ mA to 1A | 5.0 | 4.925/ 4.850 | 5.075/ 5.150 | V |
| V_{OUT} | Output Voltage | $V_{IN} = 6.5V$ to 40V, $I_{LOAD} = 20$ mA to 500 mA | 5.0 | 4.925/ 4.850 | 5.075/ 5.150 | V |
| η | Efficiency | $V_{IN} = 12V$, $I_{LOAD} = 1A$ | 90 | | | % |

LM2675-12

| Symbol | Parameter | Conditions | Typical (Note 4) | Min (Note 5) | Max (Note 5) | Units |
|--|----------------|---|---------------------|---------------------|---------------------|-------|
| SYSTEM PARAMETERS Test Circuit <i>Figure 2</i> (Note 3) | | | | | | |
| V_{OUT} | Output Voltage | $V_{IN} = 15V$ to 40V, $I_{LOAD} = 20$ mA to 1A | 12 | 11.82/ 11.64 | 12.18/ 12.36 | V |
| η | Efficiency | $V_{IN} = 24V$, $I_{LOAD} = 1A$ | 94 | | | % |

LM2675-ADJ

| Symbol | Parameter | Conditions | Typ (Note 4) | Min (Note 5) | Max (Note 5) | Units |
|--|------------------|--|-----------------|---------------------|---------------------|-------|
| SYSTEM PARAMETERS Test Circuit <i>Figure 3</i> (Note 3) | | | | | | |
| V_{FB} | Feedback Voltage | $V_{IN} = 8V$ to 40V, $I_{LOAD} = 20$ mA to 1A V_{OUT} Programmed for 5V (see Circuit of <i>Figure 3</i>) | 1.210 | 1.192/ 1.174 | 1.228/ 1.246 | V |
| V_{FB} | Feedback Voltage | $V_{IN} = 6.5V$ to 40V, $I_{LOAD} = 20$ mA to 500 mA V_{OUT} Programmed for 5V (see Circuit of <i>Figure 3</i>) | 1.210 | 1.192/ 1.174 | 1.228/ 1.246 | V |

LM2675-ADJ (Continued)

| Symbol | Parameter | Conditions | Typ (Note 4) | Min (Note 5) | Max (Note 5) | Units |
|--------|------------|-------------------------------|-----------------|-----------------|-----------------|-------|
| η | Efficiency | $V_{IN} = 12V, I_{LOAD} = 1A$ | 90 | | | % |

All Output Voltage Versions

Specifications with standard type face are for $T_J = 25^\circ C$, and those with **bold type face** apply over **full Operating Temperature Range**. Unless otherwise specified, $V_{IN} = 12V$ for the 3.3V, 5V, and Adjustable versions and $V_{IN} = 24V$ for the 12V version, and $I_{LOAD} = 100 mA$.

| Symbol | Parameters | Conditions | Typ | Min | Max | Units |
|--------------------------|------------------------------|---|------|------------|------------|--------------|
| DEVICE PARAMETERS | | | | | | |
| I_Q | Quiescent Current | $V_{FEEDBACK} = 8V$ For 3.3V, 5.0V, and ADJ Versions | 2.5 | | 3.6 | mA |
| | | $V_{FEEDBACK} = 15V$ For 12V Versions | 2.5 | | | mA |
| I_{STBY} | Standby Quiescent Current | ON/OFF Pin = 0V | 50 | | 100/150 | μA |
| I_{CL} | Current Limit | | 1.55 | 1.25/1.2 | 2.1/2.2 | A |
| I_L | Output Leakage Current | $V_{IN} = 40V, ON/OFF Pin = 0V$ $V_{SWITCH} = 0V$ | 1 | | 25 | μA |
| | | $V_{SWITCH} = -1V, ON/OFF Pin = 0V$ | 6 | | 15 | mA |
| $R_{DS(ON)}$ | Switch On-Resistance | $I_{SWITCH} = 1A$ | 0.25 | | 0.30/0.50 | Ω |
| f_O | Oscillator Frequency | Measured at Switch Pin | 260 | 225 | 275 | kHz |
| D | Maximum Duty Cycle | | 95 | | | % |
| | Minimum Duty Cycle | | 0 | | | % |
| I_{BIAS} | Feedback Bias Current | $V_{FEEDBACK} = 1.3V$ ADJ Version Only | 85 | | | nA |
| $V_{S/D}$ | ON/OFF Pin Voltage Thesholds | | 1.4 | 0.8 | 2.0 | V |
| $I_{S/D}$ | ON/OFF Pin Current | ON/OFF Pin = 0V | 20 | 7 | 37 | μA |
| θ_{JA} | Thermal Resistance | N Package, Junction to Ambient (Note 6) | 95 | | | $^\circ C/W$ |
| | | M Package, Junction to Ambient (Note 6) | 105 | | | |

Note 1: Absolute Maximum Ratings indicate limits beyond which damage to the device may occur. Operating Ratings indicate conditions for which the device is intended to be functional, but device parameter specifications may not be guaranteed under these conditions. For guaranteed specifications and test conditions, see the Electrical Characteristics.

Note 2: The human body model is a 100 pF capacitor discharged through a 1.5 k Ω resistor into each pin.

Note 3: External components such as the catch diode, inductor, input and output capacitors, and voltage programming resistors can affect switching regulator performance. When the LM2675 is used as shown in *Figures 2, 3* test circuits, system performance will be as specified by the system parameters section of the Electrical Characteristics.

Note 4: Typical numbers are at 25 $^\circ C$ and represent the most likely norm.

Note 5: All limits guaranteed at room temperature (standard type face) and at **temperature extremes (bold type face)**. All room temperature limits are 100% production tested. All limits at **temperature extremes** are guaranteed via correlation using standard Statistical Quality Control (SQC) methods. All limits are used to calculate Average Outgoing Quality Level (AOQL).

Note 6: Junction to ambient thermal resistance with approximately 1 square inch of printed circuit board copper surrounding the leads. Additional copper area will lower thermal resistance further. See Application Information section in the application note accompanying this datasheet and the thermal model in **LM267X Made Simple** software (version 6.0). The value θ_{JA} for the LLP (LD) package is specifically dependent on PCB trace area, trace material, and the number of layers and thermal vias. For improved thermal resistance and power dissipation for the LLP package, refer to Application Note AN-1187.

Typical Performance Characteristics

Normalized Output Voltage

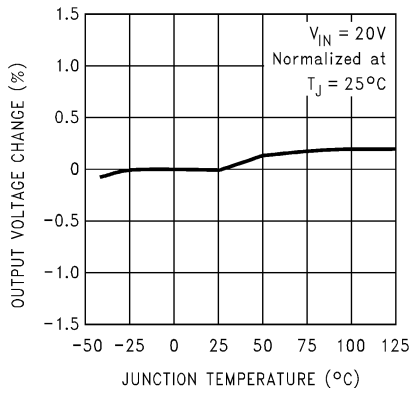

01280303

Line Regulation

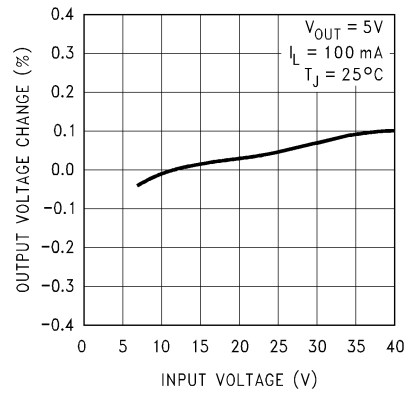

01280304

Efficiency

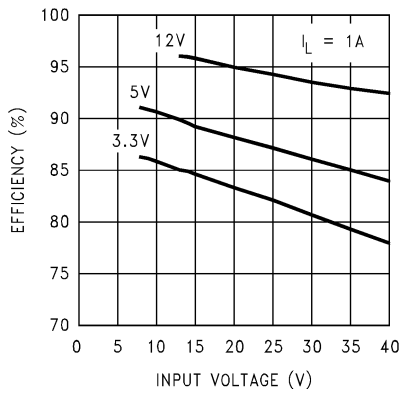

01280305

Drain-to-Source Resistance

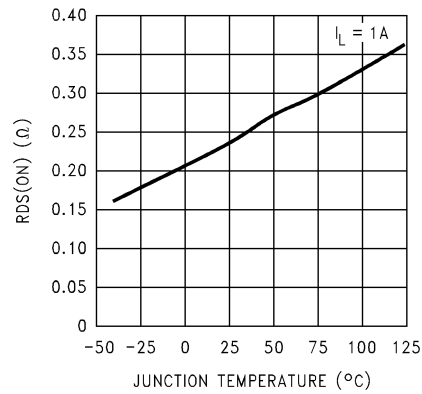

01280306

Switch Current Limit

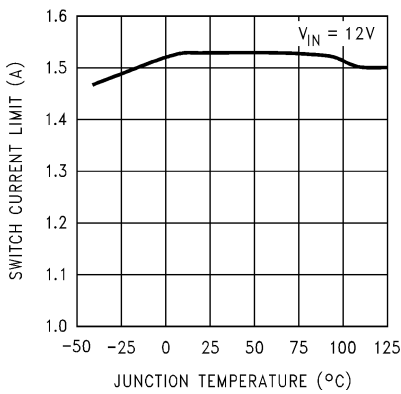

01280307

Operating Quiescent Current

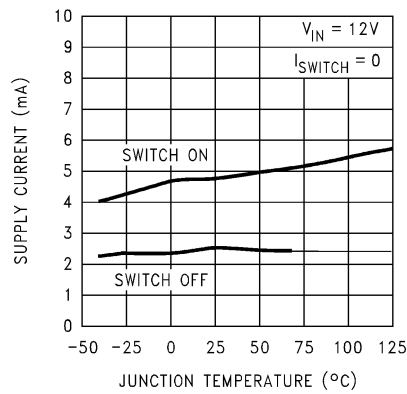

01280308

Typical Performance Characteristics (Continued)

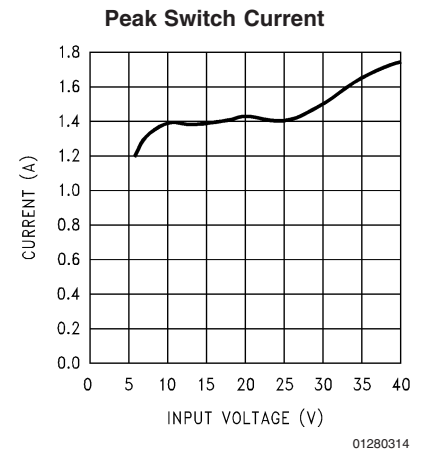
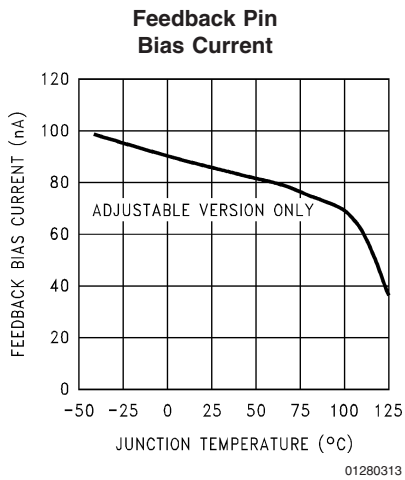
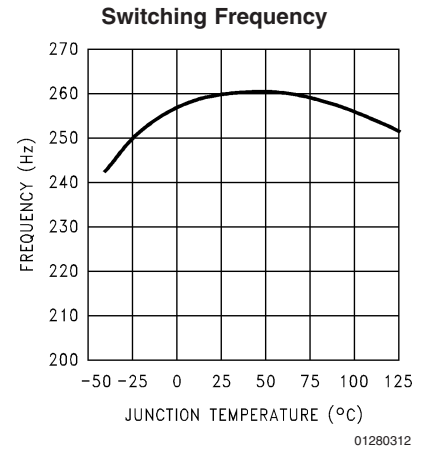
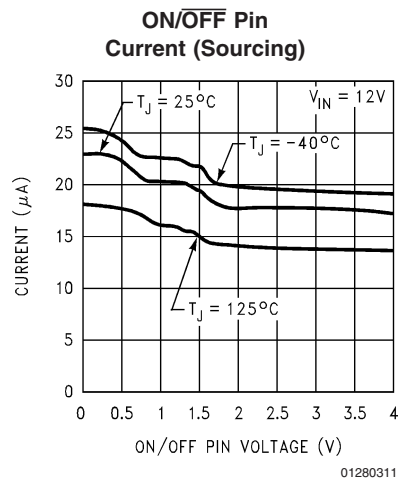
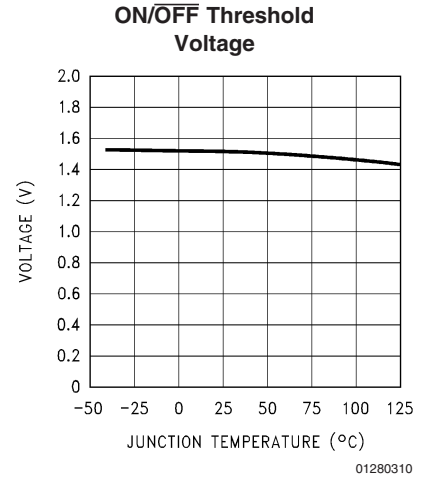
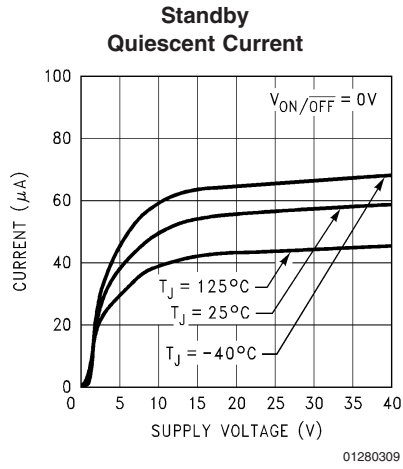

Typical Performance Characteristics (Continued)

Dropout Voltage—3.3V Option

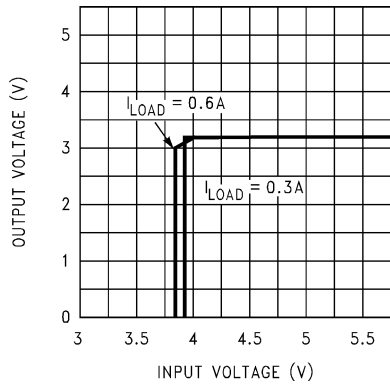

01280315

Dropout Voltage—5.0V Option

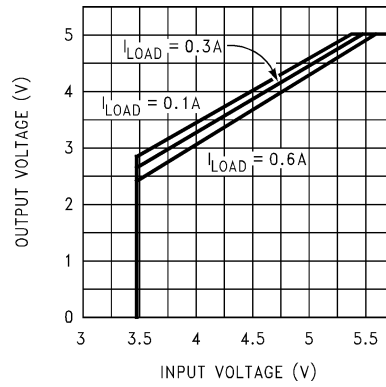

01280316

Block Diagram

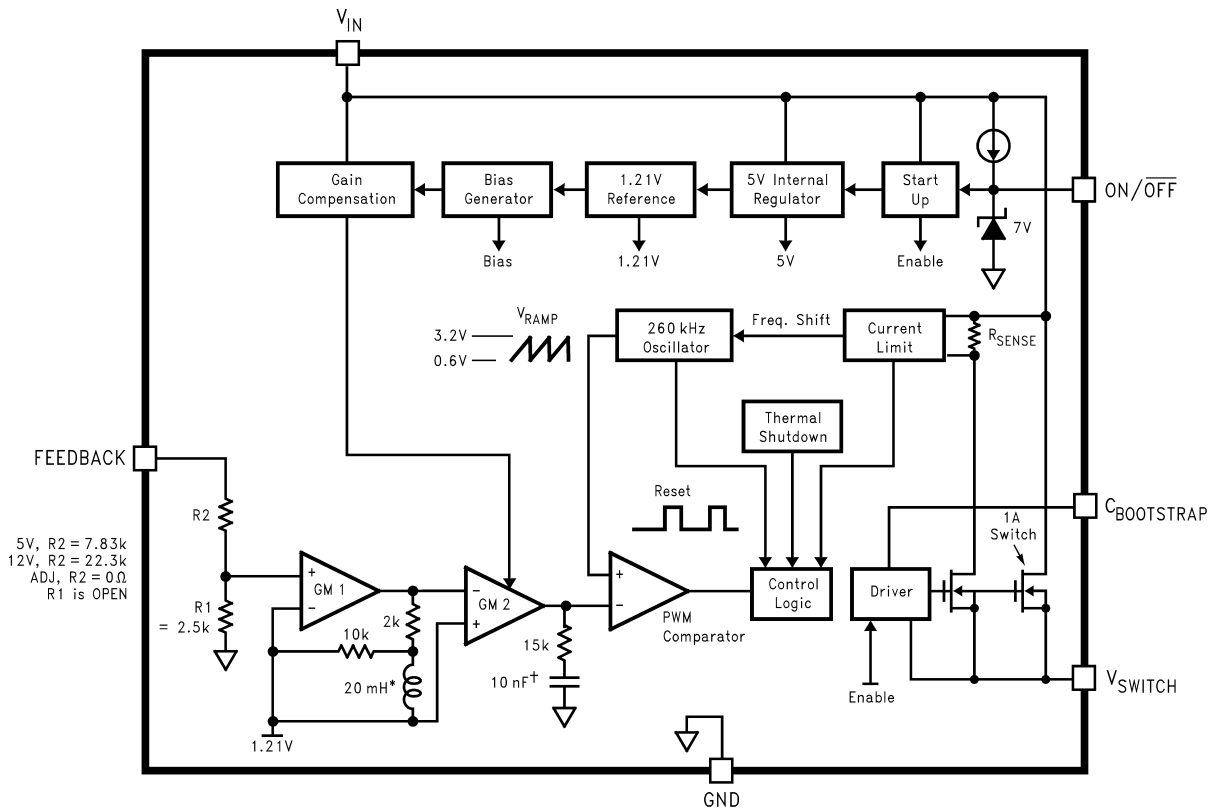

01280317

* Active Inductor Patent Number 5,514,947

† Active Capacitor Patent Number 5,382,918

FIGURE 1.

Typical Performance Characteristics (Circuit of Figure 2)

Continuous Mode Switching Waveforms

$V_{IN} = 20V, V_{OUT} = 5V, I_{LOAD} = 1A$
 $L = 47 \mu H, C_{OUT} = 68 \mu F, C_{OUT}ESR = 50 m\Omega$

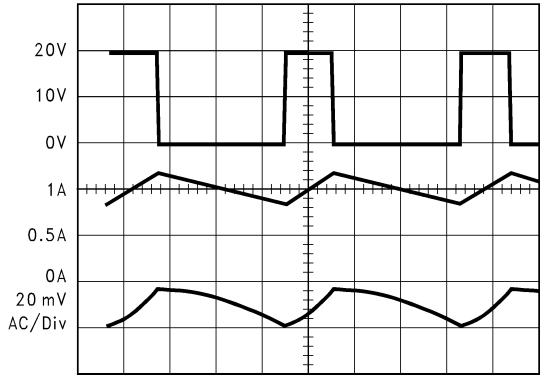

01280318

A: V_{SW} Pin Voltage, 10 V/div.
 B: Inductor Current, 0.5 A/div
 C: Output Ripple Voltage, 20 mV/div AC-Coupled

Horizontal Time Base: 1 μs /div

Discontinuous Mode Switching Waveforms

$V_{IN} = 20V, V_{OUT} = 5V, I_{LOAD} = 300 mA$
 $L = 15 \mu H, C_{OUT} = 68 \mu F (2x), C_{OUT}ESR = 25 m\Omega$

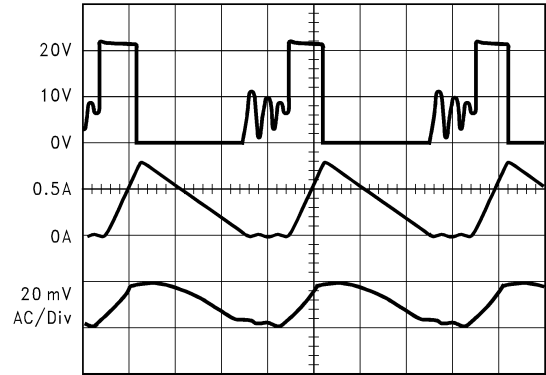

01280319

A: V_{SW} Pin Voltage, 10 V/div.
 B: Inductor Current, 0.5 A/div
 C: Output Ripple Voltage, 20 mV/div AC-Coupled

Horizontal Time Base: 1 μs /div

Load Transient Response for Continuous Mode

$V_{IN} = 20V, V_{OUT} = 5V, I_{LOAD} = 1A$
 $L = 47 \mu H, C_{OUT} = 68 \mu F, C_{OUT}ESR = 50 m\Omega$

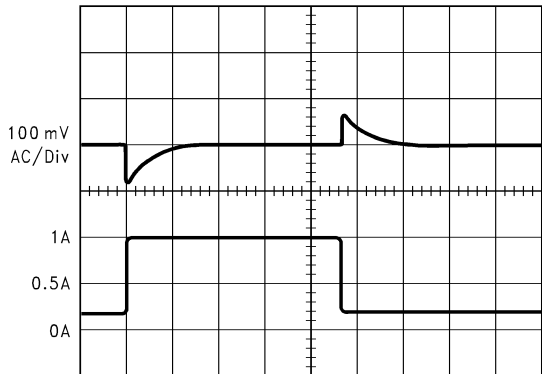

01280320

A: Output Voltage, 100 mV/div, AC-Coupled.
 B: Load Current: 200 mA to 1A Load Pulse

Horizontal Time Base: 50 μs /div

Load Transient Response for Discontinuous Mode

$V_{IN} = 20V, V_{OUT} = 5V,$
 $L = 47 \mu H, C_{OUT} = 68 \mu F, C_{OUT}ESR = 50 m\Omega$

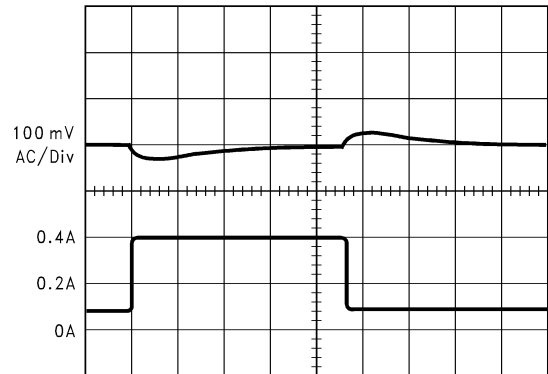

01280321

A: Output Voltage, 100 mV/div, AC-Coupled.
 B: Load Current: 100 mA to 400 mA Load Pulse

Horizontal Time Base: 200 μs /div

Test Circuit and Layout Guidelines

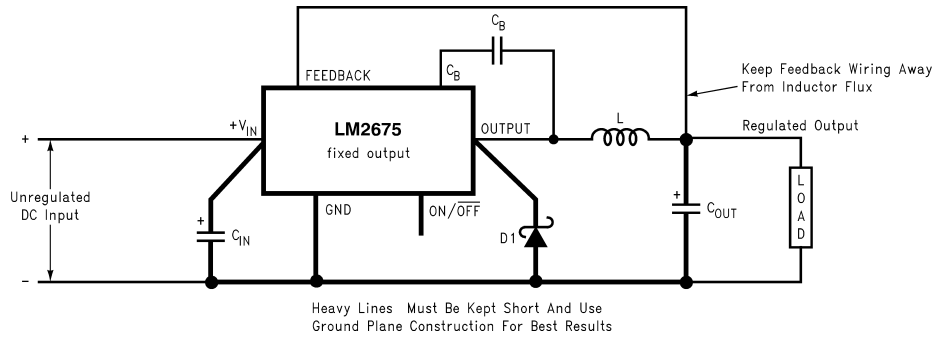

01280322

- C_{IN} - 22 μF, 50V Tantalum, Sprague "199D Series"
- C_{OUT} - 47 μF, 25V Tantalum, Sprague "595D Series"
- D1 - 3.3A, 50V Schottky Rectifier, IR 30WQ05F
- L1 - 68 μH Sumida #RCR110D-680L
- C_B - 0.01 μF, 50V Ceramic

**FIGURE 2. Standard Test Circuits and Layout Guides
Fixed Output Voltage Versions**

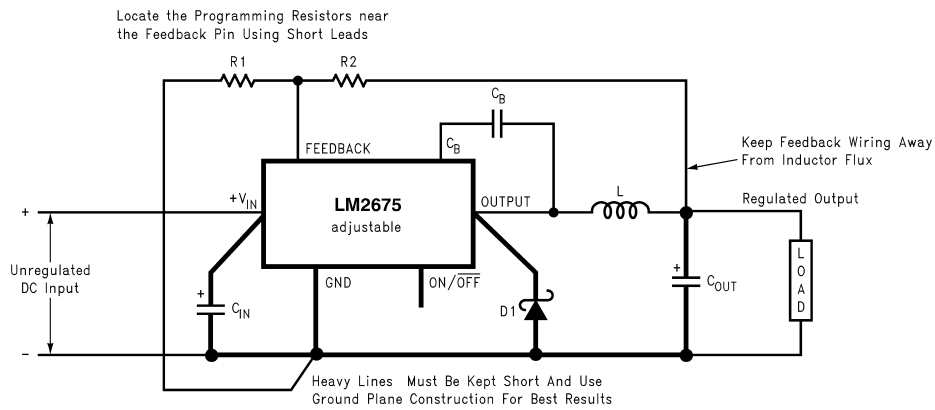

01280323

- C_{IN} - 22 μF, 50V Tantalum, Sprague "199D Series"
- C_{OUT} - 47 μF, 25V Tantalum, Sprague "595D Series"
- D1 - 3.3A, 50V Schottky Rectifier, IR 30WQ05F
- L1 - 68 μH Sumida #RCR110D-680L
- R1 - 1.5 kΩ, 1%
- C_B - 0.01 μF, 50V Ceramic
- For a 5V output, select R2 to be 4.75 kΩ, 1%

$$V_{OUT} = V_{REF} \left(1 + \frac{R_2}{R_1} \right)$$

where $V_{REF} = 1.21V$

$$R_2 = R_1 \left(\frac{V_{OUT}}{V_{REF}} - 1 \right)$$

Use a 1% resistor for best stability.

**FIGURE 3. Standard Test Circuits and Layout Guides
Adjustable Output Voltage Version**

LM2675 Series Buck Regulator Design Procedure (Fixed Output)

| PROCEDURE (Fixed Output Voltage Version) | EXAMPLE (Fixed Output Voltage Version) |
|---|---|
| <p>To simplify the buck regulator design procedure, National Semiconductor is making available computer design software to be used with the SIMPLE SWITCHER line of switching regulators. LM267X Made Simple version 6.0 is available on Windows® 3.1, NT, or 95 operating systems.</p> <p>Given:</p> <p>V_{OUT} = Regulated Output Voltage (3.3V, 5V, or 12V) $V_{IN(max)}$ = Maximum DC Input Voltage $I_{LOAD(max)}$ = Maximum Load Current</p> <p>1. Inductor Selection (L1)</p> <p>A. Select the correct inductor value selection guide from <i>Figure 4</i>, <i>Figure 5</i> or <i>Figure 6</i> (output voltages of 3.3V, 5V, or 12V respectively). For all other voltages, see the design procedure for the adjustable version.</p> <p>B. From the inductor value selection guide, identify the inductance region intersected by the Maximum Input Voltage line and the Maximum Load Current line. Each region is identified by an inductance value and an inductor code (LXX).</p> <p>C. Select an appropriate inductor from the four manufacturer's part numbers listed in <i>Figure 8</i>. Each manufacturer makes a different style of inductor to allow flexibility in meeting various design requirements. Listed below are some of the differentiating characteristics of each manufacturer's inductors:</p> <p><i>Schott</i>: ferrite EP core inductors; these have very low leakage magnetic fields to reduce electro-magnetic interference (EMI) and are the lowest power loss inductors</p> <p><i>Renco</i>: ferrite stick core inductors; benefits are typically lowest cost inductors and can withstand E•T and transient peak currents above rated value. Be aware that these inductors have an external magnetic field which may generate more EMI than other types of inductors.</p> <p><i>Pulse</i>: powdered iron toroid core inductors; these can also be low cost and can withstand larger than normal E•T and transient peak currents. Toroid inductors have low EMI.</p> <p><i>Coilcraft</i>: ferrite drum core inductors; these are the smallest physical size inductors, available only as SMT components. Be aware that these inductors also generate EMI—but less than stick inductors.</p> <p>Complete specifications for these inductors are available from the respective manufacturers. A table listing the manufacturers' phone numbers is located in <i>Figure 9</i>.</p> <p>2. Output Capacitor Selection (C_{OUT})</p> <p>A. Select an output capacitor from the output capacitor table in <i>Figure 10</i>. Using the output voltage and the inductance value found in the inductor selection guide, step 1, locate the appropriate capacitor value and voltage rating.</p> | <p>Given:</p> <p>V_{OUT} = 5V $V_{IN(max)}$ = 12V $I_{LOAD(max)}$ = 1A</p> <p>1. Inductor Selection (L1)</p> <p>A. Use the inductor selection guide for the 5V version shown in <i>Figure 5</i>.</p> <p>B. From the inductor value selection guide shown in <i>Figure 5</i>, the inductance region intersected by the 12V horizontal line and the 1A vertical line is 33 μH, and the inductor code is L23.</p> <p>C. The inductance value required is 33 μH. From the table in <i>Figure 8</i>, go to the L23 line and choose an inductor part number from any of the four manufacturers shown. (In most instances, both through hole and surface mount inductors are available.)</p> <p>2. Output Capacitor Selection (C_{OUT})</p> <p>A. Use the 5.0V section in the output capacitor table in <i>Figure 10</i>. Choose a capacitor value and voltage rating from the line that contains the inductance value of 33 μH. The capacitance and voltage rating values corresponding to the 33 μH inductor are the:</p> |

LM2675 Series Buck Regulator Design Procedure (Fixed Output) (Continued)

| PROCEDURE (Fixed Output Voltage Version) | EXAMPLE (Fixed Output Voltage Version) |
|--|--|
| <p>The capacitor list contains through-hole electrolytic capacitors from four different capacitor manufacturers and surface mount tantalum capacitors from two different capacitor manufacturers. It is recommended that both the manufacturers and the manufacturer's series that are listed in the table be used. A table listing the manufacturers' phone numbers is located in <i>Figure 11</i>.</p> <p>3. Catch Diode Selection (D1)</p> <p>A. In normal operation, the average current of the catch diode is the load current times the catch diode duty cycle, 1-D (D is the switch duty cycle, which is approximately the output voltage divided by the input voltage). The largest value of the catch diode average current occurs at the maximum load current and maximum input voltage (minimum D). For normal operation, the catch diode current rating must be at least 1.3 times greater than its maximum average current. However, if the power supply design must withstand a continuous output short, the diode should have a current rating equal to the maximum current limit of the LM2675. The most stressful condition for this diode is a shorted output condition.</p> <p>B. The reverse voltage rating of the diode should be at least 1.25 times the maximum input voltage.</p> <p>C. Because of their fast switching speed and low forward voltage drop, Schottky diodes provide the best performance and efficiency. This Schottky diode must be located close to the LM2675 using short leads and short printed circuit traces.</p> <p>4. Input Capacitor (C_{IN})</p> | <p>Surface Mount: 68 μF/10V Sprague 594D Series. 100 μF/10V AVX TPS Series.</p> <p>Through Hole: 68 μF/10V Sanyo OS-CON SA Series. 220 μF/35V Sanyo MV-GX Series. 220 μF/35V Nichicon PL Series. 220 μF/35V Panasonic HFQ Series.</p> <p>3. Catch Diode Selection (D1)</p> <p>A. Refer to the table shown in <i>Figure 12</i>. In this example, a 1A, 20V Schottky diode will provide the best performance. If the circuit must withstand a continuous shorted output, a higher current Schottky diode is recommended.</p> <p>4. Input Capacitor (C_{IN})</p> |

LM2675 Series Buck Regulator Design Procedure (Fixed Output) (Continued)

| PROCEDURE (Fixed Output Voltage Version) | EXAMPLE (Fixed Output Voltage Version) |
|---|---|
| <p>A low ESR aluminum or tantalum bypass capacitor is needed between the input pin and ground to prevent large voltage transients from appearing at the input. This capacitor should be located close to the IC using short leads. In addition, the RMS current rating of the input capacitor should be selected to be at least $\frac{1}{2}$ the DC load current. The capacitor manufacturer data sheet must be checked to assure that this current rating is not exceeded. The curves shown in <i>Figure 14</i> show typical RMS current ratings for several different aluminum electrolytic capacitor values. A parallel connection of two or more capacitors may be required to increase the total minimum RMS current rating to suit the application requirements.</p> <p>For an aluminum electrolytic capacitor, the voltage rating should be at least 1.25 times the maximum input voltage. Caution must be exercised if solid tantalum capacitors are used. The tantalum capacitor voltage rating should be twice the maximum input voltage. The tables in <i>Figure 15</i> show the recommended application voltage for AVX TPS and Sprague 594D tantalum capacitors. It is also recommended that they be surge current tested by the manufacturer. The TPS series available from AVX, and the 593D and 594D series from Sprague are all surge current tested. Another approach to minimize the surge current stresses on the input capacitor is to add a small inductor in series with the input supply line.</p> <p>Use caution when using ceramic capacitors for input bypassing, because it may cause severe ringing at the V_{IN} pin.</p> <p>5. Boost Capacitor (C_B)</p> <p>This capacitor develops the necessary voltage to turn the switch gate on fully. All applications should use a 0.01 μF, 50V ceramic capacitor.</p> | <p>The important parameters for the input capacitor are the input voltage rating and the RMS current rating. With a maximum input voltage of 12V, an aluminum electrolytic capacitor with a voltage rating greater than 15V ($1.25 \times V_{IN}$) would be needed. The next higher capacitor voltage rating is 16V.</p> <p>The RMS current rating requirement for the input capacitor in a buck regulator is approximately $\frac{1}{2}$ the DC load current. In this example, with a 1A load, a capacitor with a RMS current rating of at least 500 mA is needed. The curves shown in <i>Figure 14</i> can be used to select an appropriate input capacitor. From the curves, locate the 16V line and note which capacitor values have RMS current ratings greater than 500 mA.</p> <p>For a through hole design, a 330 $\mu\text{F}/16\text{V}$ electrolytic capacitor (Panasonic HFQ series, Nichicon PL, Sanyo MV-GX series or equivalent) would be adequate. Other types or other manufacturers' capacitors can be used provided the RMS ripple current ratings are adequate. Additionally, for a complete surface mount design, electrolytic capacitors such as the Sanyo CV-C or CV-BS and the Nichicon WF or UR and the NIC Components NACZ series could be considered.</p> <p>For surface mount designs, solid tantalum capacitors can be used, but caution must be exercised with regard to the capacitor surge current rating and voltage rating. In this example, checking <i>Figure 15</i>, and the Sprague 594D series datasheet, a Sprague 594D 15 μF, 25V capacitor is adequate.</p> <p>5. Boost Capacitor (C_B)</p> <p>For this application, and all applications, use a 0.01 μF, 50V ceramic capacitor.</p> |

LM2675 Series Buck Regulator Design Procedure (Fixed Output) (Continued)

Inductor Value Selection Guides

(For Continuous Mode Operation)

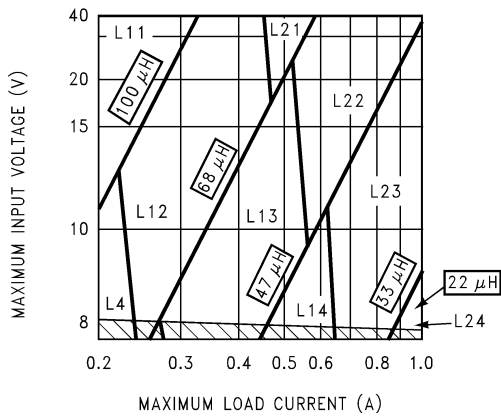

01280326

FIGURE 4. LM2675-3.3

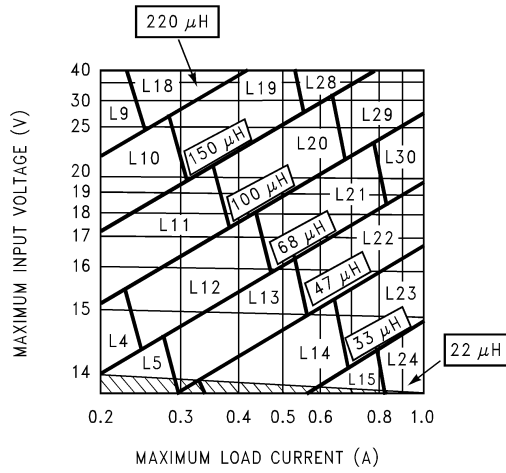

01280328

FIGURE 6. LM2675-12

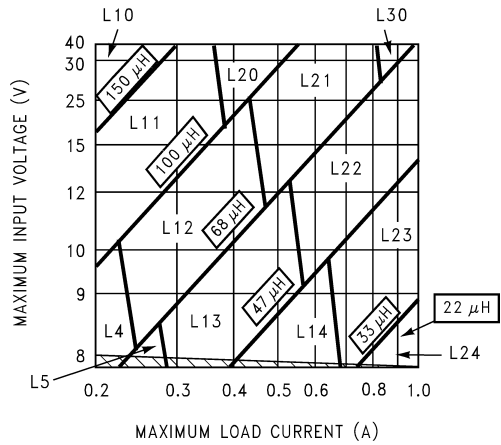

01280327

FIGURE 5. LM2675-5.0

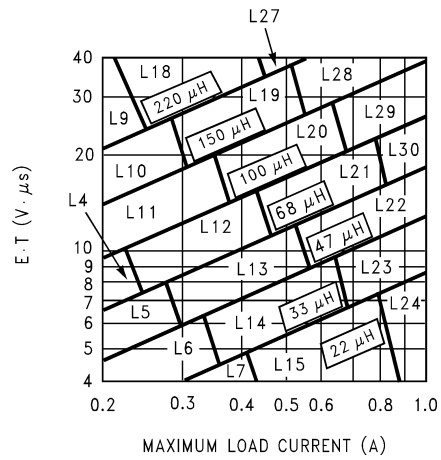

01280329

FIGURE 7. LM2675-ADJ

LM2675 Series Buck Regulator Design Procedure (Fixed Output) (Continued)

| Ind. Ref. Desg. | Inductance (μ H) | Current (A) | Schott | | Renco | | Pulse Engineering | | Coilcraft |
|-----------------|-----------------------|-------------|--------------|---------------|---------------|---------------|-------------------|---------------|---------------|
| | | | Through Hole | Surface Mount | Through Hole | Surface Mount | Through Hole | Surface Mount | Surface Mount |
| L4 | 68 | 0.32 | 67143940 | 67144310 | RL-1284-68-43 | RL1500-68 | PE-53804 | PE-53804-S | DO1608-683 |
| L5 | 47 | 0.37 | 67148310 | 67148420 | RL-1284-47-43 | RL1500-47 | PE-53805 | PE-53805-S | DO1608-473 |
| L6 | 33 | 0.44 | 67148320 | 67148430 | RL-1284-33-43 | RL1500-33 | PE-53806 | PE-53806-S | DO1608-333 |
| L7 | 22 | 0.52 | 67148330 | 67148440 | RL-1284-22-43 | RL1500-22 | PE-53807 | PE-53807-S | DO1608-223 |
| L9 | 220 | 0.32 | 67143960 | 67144330 | RL-5470-3 | RL1500-220 | PE-53809 | PE-53809-S | DO3308-224 |
| L10 | 150 | 0.39 | 67143970 | 67144340 | RL-5470-4 | RL1500-150 | PE-53810 | PE-53810-S | DO3308-154 |
| L11 | 100 | 0.48 | 67143980 | 67144350 | RL-5470-5 | RL1500-100 | PE-53811 | PE-53811-S | DO3308-104 |
| L12 | 68 | 0.58 | 67143990 | 67144360 | RL-5470-6 | RL1500-68 | PE-53812 | PE-53812-S | DO3308-683 |
| L13 | 47 | 0.70 | 67144000 | 67144380 | RL-5470-7 | RL1500-47 | PE-53813 | PE-53813-S | DO3308-473 |
| L14 | 33 | 0.83 | 67148340 | 67148450 | RL-1284-33-43 | RL1500-33 | PE-53814 | PE-53814-S | DO3308-333 |
| L15 | 22 | 0.99 | 67148350 | 67148460 | RL-1284-22-43 | RL1500-22 | PE-53815 | PE-53815-S | DO3308-223 |
| L18 | 220 | 0.55 | 67144040 | 67144420 | RL-5471-2 | RL1500-220 | PE-53818 | PE-53818-S | DO3316-224 |
| L19 | 150 | 0.66 | 67144050 | 67144430 | RL-5471-3 | RL1500-150 | PE-53819 | PE-53819-S | DO3316-154 |
| L20 | 100 | 0.82 | 67144060 | 67144440 | RL-5471-4 | RL1500-100 | PE-53820 | PE-53820-S | DO3316-104 |
| L21 | 68 | 0.99 | 67144070 | 67144450 | RL-5471-5 | RL1500-68 | PE-53821 | PE-53821-S | DO3316-683 |
| L22 | 47 | 1.17 | 67144080 | 67144460 | RL-5471-6 | — | PE-53822 | PE-53822-S | DO3316-473 |
| L23 | 33 | 1.40 | 67144090 | 67144470 | RL-5471-7 | — | PE-53823 | PE-53823-S | DO3316-333 |
| L24 | 22 | 1.70 | 67148370 | 67148480 | RL-1283-22-43 | — | PE-53824 | PE-53824-S | DO3316-223 |
| L27 | 220 | 1.00 | 67144110 | 67144490 | RL-5471-2 | — | PE-53827 | PE-53827-S | DO5022P-224 |
| L28 | 150 | 1.20 | 67144120 | 67144500 | RL-5471-3 | — | PE-53828 | PE-53828-S | DO5022P-154 |
| L29 | 100 | 1.47 | 67144130 | 67144510 | RL-5471-4 | — | PE-53829 | PE-53829-S | DO5022P-104 |
| L30 | 68 | 1.78 | 67144140 | 67144520 | RL-5471-5 | — | PE-53830 | PE-53830-S | DO5022P-683 |

FIGURE 8. Inductor Manufacturers' Part Numbers

| | | |
|---------------------------------------|-------|------------------|
| Coilcraft Inc. | Phone | (800) 322-2645 |
| | FAX | (708) 639-1469 |
| Coilcraft Inc., Europe | Phone | +44 1236 730 595 |
| | FAX | +44 1236 730 627 |
| Pulse Engineering Inc. | Phone | (619) 674-8100 |
| | FAX | (619) 674-8262 |
| Pulse Engineering Inc., Europe | Phone | +353 93 24 107 |
| | FAX | +353 93 24 459 |
| Renco Electronics Inc. | Phone | (800) 645-5828 |
| | FAX | (516) 586-5562 |
| Schott Corp. | Phone | (612) 475-1173 |
| | FAX | (612) 475-1786 |

FIGURE 9. Inductor Manufacturers' Phone Numbers

LM2675 Series Buck Regulator Design Procedure (Fixed Output) (Continued)

| Output Voltage (V) | Inductance (μ H) | Output Capacitor | | | | | |
|--------------------|-----------------------|----------------------------------|-----------------------------|-------------------------------------|---------------------------------|---------------------------------|-----------------------------------|
| | | Surface Mount | | Through Hole | | | |
| | | Sprague 594D Series (μ F/V) | AVX TPS Series (μ F/V) | Sanyo OS-CON SA Series (μ F/V) | Sanyo MV-GX Series (μ F/V) | Nichicon PL Series (μ F/V) | Panasonic HFQ Series (μ F/V) |
| 3.3 | 22 | 120/6.3 | 100/10 | 100/10 | 330/35 | 330/35 | 330/35 |
| | 33 | 120/6.3 | 100/10 | 68/10 | 220/35 | 220/35 | 220/35 |
| | 47 | 68/10 | 100/10 | 68/10 | 150/35 | 150/35 | 150/35 |
| | 68 | 120/6.3 | 100/10 | 100/10 | 120/35 | 120/35 | 120/35 |
| | 100 | 120/6.3 | 100/10 | 100/10 | 120/35 | 120/35 | 120/35 |
| | 150 | 120/6.3 | 100/10 | 100/10 | 120/35 | 120/35 | 120/35 |
| 5.0 | 22 | 100/16 | 100/10 | 100/10 | 330/35 | 330/35 | 330/35 |
| | 33 | 68/10 | 100/10 | 68/10 | 220/35 | 220/35 | 220/35 |
| | 47 | 68/10 | 100/10 | 68/10 | 150/35 | 150/35 | 150/35 |
| | 68 | 100/16 | 100/10 | 100/10 | 120/35 | 120/35 | 120/35 |
| | 100 | 100/16 | 100/10 | 100/10 | 120/35 | 120/35 | 120/35 |
| | 150 | 100/16 | 100/10 | 100/10 | 120/35 | 120/35 | 120/35 |
| 12 | 22 | 120/20 | (2x) 68/20 | 68/20 | 330/35 | 330/35 | 330/35 |
| | 33 | 68/25 | 68/20 | 68/20 | 220/35 | 220/35 | 220/35 |
| | 47 | 47/20 | 68/20 | 47/20 | 150/35 | 150/35 | 150/35 |
| | 68 | 47/20 | 68/20 | 47/20 | 120/35 | 120/35 | 120/35 |
| | 100 | 47/20 | 68/20 | 47/20 | 120/35 | 120/35 | 120/35 |
| | 150 | 47/20 | 68/20 | 47/20 | 120/35 | 120/35 | 120/35 |
| | 220 | 47/20 | 68/20 | 47/20 | 120/35 | 120/35 | 120/35 |

FIGURE 10. Output Capacitor Table

| | | |
|----------------|-------|----------------|
| Nichicon Corp. | Phone | (847) 843-7500 |
| | FAX | (847) 843-2798 |
| Panasonic | Phone | (714) 373-7857 |
| | FAX | (714) 373-7102 |
| AVX Corp. | Phone | (803) 448-9411 |
| | FAX | (803) 448-1943 |
| Sprague/Vishay | Phone | (207) 324-4140 |
| | FAX | (207) 324-7223 |
| Sanyo Corp. | Phone | (619) 661-6322 |
| | FAX | (619) 661-1055 |

FIGURE 11. Capacitor Manufacturers' Phone Numbers

LM2675 Series Buck Regulator Design Procedure (Fixed Output) (Continued)

| V _R | 1A Diodes | | 3A Diodes | |
|----------------|---------------|--------------|---------------|--------------|
| | Surface Mount | Through Hole | Surface Mount | Through Hole |
| 20V | SK12 | 1N5817 | SK32 | 1N5820 |
| | B120 | SR102 | | SR302 |
| 30V | SK13 | 1N5818 | SK33 | 1N5821 |
| | B130 | 11DQ03 | 30WQ03F | 31DQ03 |
| | MBRS130 | SR103 | | |
| 40V | SK14 | 1N5819 | SK34 | 1N5822 |
| | B140 | 11DQ04 | 30BQ040 | MBR340 |
| | MBRS140 | SR104 | 30WQ04F | 31DQ04 |
| | 10BQ040 | | MBRS340 | SR304 |
| | 10MQ040 | | MBRD340 | |
| 50V | SK15 | MBR150 | SK35 | MBR350 |
| | B150 | 11DQ05 | 30WQ05F | 31DQ05 |
| | 10BQ050 | SR105 | | SR305 |

FIGURE 12. Schottky Diode Selection Table

| | | |
|--------------------------------------|-------|----------------|
| International Rectifier Corp. | Phone | (310) 322-3331 |
| | FAX | (310) 322-3332 |
| Motorola, Inc. | Phone | (800) 521-6274 |
| | FAX | (602) 244-6609 |
| General Instruments Corp. | Phone | (516) 847-3000 |
| | FAX | (516) 847-3236 |
| Diodes, Inc. | Phone | (805) 446-4800 |
| | FAX | (805) 446-4850 |

FIGURE 13. Diode Manufacturers' Phone Numbers

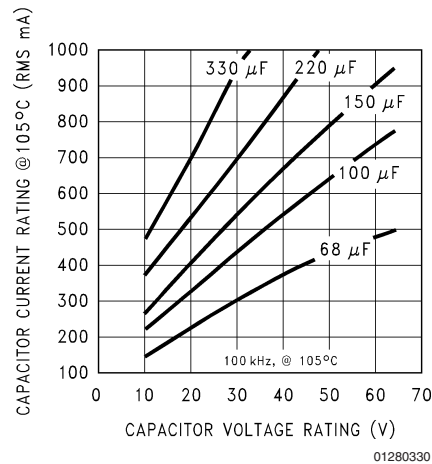

FIGURE 14. RMS Current Ratings for Low ESR Electrolytic Capacitors (Typical)

LM2675 Series Buck Regulator Design Procedure (Fixed Output) (Continued)

AVX TPS

| Recommended Application Voltage | Voltage Rating |
|---------------------------------|----------------|
| +85°C Rating | |
| 3.3 | 6.3 |
| 5 | 10 |
| 10 | 20 |
| 12 | 25 |
| 15 | 35 |

Sprague 594D

| Recommended Application Voltage | Voltage Rating |
|---------------------------------|----------------|
| +85°C Rating | |
| 2.5 | 4 |
| 3.3 | 6.3 |
| 5 | 10 |
| 8 | 16 |
| 12 | 20 |
| 18 | 25 |
| 24 | 35 |
| 29 | 50 |

FIGURE 15.

LM2675 Series Buck Regulator Design Procedure (Adjustable Output)

| PROCEDURE (Adjustable Output Voltage Version) | EXAMPLE (Adjustable Output Voltage Version) |
|---|---|
| <p>To simplify the buck regulator design procedure, National Semiconductor is making available computer design software to be used with the SIMPLE SWITCHER line of switching regulators. LM267X Made Simple version 6.0 is available for use on Windows 3.1, NT, or 95 operating systems.</p> <p>Given:</p> <p>V_{OUT} = Regulated Output Voltage $V_{IN(max)}$ = Maximum Input Voltage $I_{LOAD(max)}$ = Maximum Load Current F = Switching Frequency (Fixed at a nominal 260 kHz).</p> <p>1. Programming Output Voltage (Selecting R_1 and R_2, as shown in Figure 3)</p> <p>Use the following formula to select the appropriate resistor values.</p> $V_{OUT} = V_{REF} \left(1 + \frac{R_2}{R_1} \right)$ <p>where $V_{REF} = 1.21V$</p> <p>Select a value for R_1 between 240Ω and 1.5 kΩ. The lower resistor values minimize noise pickup in the sensitive feedback pin. (For the lowest temperature coefficient and the best stability with time, use 1% metal film resistors.)</p> $R_2 = R_1 \left(\frac{V_{OUT}}{V_{REF}} - 1 \right)$ | <p>Given:</p> <p>$V_{OUT} = 20V$ $V_{IN(max)} = 28V$ $I_{LOAD(max)} = 1A$ F = Switching Frequency (Fixed at a nominal 260 kHz).</p> <p>1. Programming Output Voltage (Selecting R_1 and R_2, as shown in Figure 3)</p> <p>Select R_1 to be 1 kΩ, 1%. Solve for R_2.</p> $R_2 = R_1 \left(\frac{V_{OUT}}{V_{REF}} - 1 \right) = 1 \text{ k}\Omega \left(\frac{20V}{1.23V} - 1 \right)$ <p>$R_2 = 1k (16.53 - 1) = 15.53 \text{ k}\Omega$, closest 1% value is 15.4 kΩ. $R_2 = 15.4 \text{ k}\Omega$.</p> |

LM2675 Series Buck Regulator Design Procedure (Adjustable Output)

(Continued)

| PROCEDURE (Adjustable Output Voltage Version) | EXAMPLE (Adjustable Output Voltage Version) |
|---|--|
| <p>2. Inductor Selection (L1)</p> <p>A. Calculate the inductor Volt • microsecond constant $E \cdot T$ ($V \cdot \mu s$), from the following formula:</p> $E \cdot T = (V_{IN(MAX)} - V_{OUT} - V_{SAT}) \cdot \frac{V_{OUT} + V_D}{V_{IN(MAX)} - V_{SAT} + V_D} \cdot \frac{1000}{260} (V \cdot \mu s)$ <p>where V_{SAT} = internal switch saturation voltage = 0.25V and V_D = diode forward voltage drop = 0.5V</p> <p>B. Use the $E \cdot T$ value from the previous formula and match it with the $E \cdot T$ number on the vertical axis of the Inductor Value Selection Guide shown in <i>Figure 7</i>.</p> <p>C. On the horizontal axis, select the maximum load current.</p> <p>D. Identify the inductance region intersected by the $E \cdot T$ value and the Maximum Load Current value. Each region is identified by an inductance value and an inductor code (LXX).</p> <p>E. Select an appropriate inductor from the four manufacturer's part numbers listed in <i>Figure 8</i>. For information on the different types of inductors, see the inductor selection in the fixed output voltage design procedure.</p> | <p>2. Inductor Selection (L1)</p> <p>A. Calculate the inductor Volt • microsecond constant ($E \cdot T$),</p> $E \cdot T = (28 - 20 - 0.25) \cdot \frac{20 + 0.5}{28 - 0.25 + 0.5} \cdot \frac{1000}{260} (V \cdot \mu s)$ $E \cdot T = (7.75) \cdot \frac{20.5}{28.25} \cdot 3.85 (V \cdot \mu s) = 21.6 (V \cdot \mu s)$ <p>B. $E \cdot T = 21.6 (V \cdot \mu s)$</p> <p>C. $I_{LOAD(max)} = 1A$</p> <p>D. From the inductor value selection guide shown in <i>Figure 7</i>, the inductance region intersected by the 21.6 ($V \cdot \mu s$) horizontal line and the 1A vertical line is 68 μH, and the inductor code is L30.</p> <p>E. From the table in <i>Figure 8</i>, locate line L30, and select an inductor part number from the list of manufacturers part numbers.</p> |
| <p>3. Output Capacitor Selection (C_{OUT})</p> <p>A. Select an output capacitor from the capacitor code selection guide in <i>Figure 16</i>. Using the inductance value found in the inductor selection guide, step 1, locate the appropriate capacitor code corresponding to the desired output voltage.</p> <p>B. Select an appropriate capacitor value and voltage rating, using the capacitor code, from the output capacitor selection table in <i>Figure 17</i>. There are two solid tantalum (surface mount) capacitor manufacturers and four electrolytic (through hole) capacitor manufacturers to choose from. It is recommended that both the manufacturers and the manufacturer's series that are listed in the table be used. A table listing the manufacturers' phone numbers is located in <i>Figure 11</i>.</p> | <p>3. Output Capacitor Selection (C_{OUT})</p> <p>A. Use the appropriate row of the capacitor code selection guide, in <i>Figure 16</i>. For this example, use the 15–20V row. The capacitor code corresponding to an inductance of 68 μH is C20.</p> <p>B. From the output capacitor selection table in <i>Figure 17</i>, choose a capacitor value (and voltage rating) that intersects the capacitor code(s) selected in section A, C20. The capacitance and voltage rating values corresponding to the capacitor code C20 are the:</p> <p>Surface Mount: 33 $\mu F/25V$ Sprague 594D Series. 33 $\mu F/25V$ AVX TPS Series.</p> <p>Through Hole: 33 $\mu F/25V$ Sanyo OS-CON SC Series. 120 $\mu F/35V$ Sanyo MV-GX Series. 120 $\mu F/35V$ Nichicon PL Series. 120 $\mu F/35V$ Panasonic HFQ Series.</p> <p>Other manufacturers or other types of capacitors may also be used, provided the capacitor specifications (especially the 100 kHz ESR) closely match the characteristics of the capacitors listed in the output capacitor table. Refer to the capacitor manufacturers' data sheet for this information.</p> |

LM2675 Series Buck Regulator Design Procedure (Adjustable Output)

(Continued)

| PROCEDURE (Adjustable Output Voltage Version) | EXAMPLE (Adjustable Output Voltage Version) |
|---|---|
| <p>4. Catch Diode Selection (D1)</p> <p>A. In normal operation, the average current of the catch diode is the load current times the catch diode duty cycle, 1-D (D is the switch duty cycle, which is approximately V_{OUT}/V_{IN}). The largest value of the catch diode average current occurs at the maximum input voltage (minimum D). For normal operation, the catch diode current rating must be at least 1.3 times greater than its maximum average current. However, if the power supply design must withstand a continuous output short, the diode should have a current rating greater than the maximum current limit of the LM2675. The most stressful condition for this diode is a shorted output condition.</p> <p>B. The reverse voltage rating of the diode should be at least 1.25 times the maximum input voltage.</p> <p>C. Because of their fast switching speed and low forward voltage drop, Schottky diodes provide the best performance and efficiency. The Schottky diode must be located close to the LM2675 using short leads and short printed circuit traces.</p> <p>5. Input Capacitor (C_{IN})</p> <p>A low ESR aluminum or tantalum bypass capacitor is needed between the input pin and ground to prevent large voltage transients from appearing at the input. This capacitor should be located close to the IC using short leads. In addition, the RMS current rating of the input capacitor should be selected to be at least ½ the DC load current. The capacitor manufacturer data sheet must be checked to assure that this current rating is not exceeded. The curves shown in <i>Figure 14</i> show typical RMS current ratings for several different aluminum electrolytic capacitor values. A parallel connection of two or more capacitors may be required to increase the total minimum RMS current rating to suit the application requirements.</p> <p>For an aluminum electrolytic capacitor, the voltage rating should be at least 1.25 times the maximum input voltage. Caution must be exercised if solid tantalum capacitors are used. The tantalum capacitor voltage rating should be twice the maximum input voltage. The tables in <i>Figure 15</i> show the recommended application voltage for AVX TPS and Sprague 594D tantalum capacitors. It is also recommended that they be surge current tested by the manufacturer. The TPS series available from AVX, and the 593D and 594D series from Sprague are all surge current tested. Another approach to minimize the surge current stresses on the input capacitor is to add a small inductor in series with the input supply line.</p> <p>Use caution when using ceramic capacitors for input bypassing, because it may cause severe ringing at the V_{IN} pin.</p> <p>6. Boost Capacitor (C_B)</p> <p>This capacitor develops the necessary voltage to turn the switch gate on fully. All applications should use a 0.01 μF, 50V ceramic capacitor.</p> | <p>4. Catch Diode Selection (D1)</p> <p>A. Refer to the table shown in <i>Figure 12</i>. Schottky diodes provide the best performance, and in this example a 1A, 40V Schottky diode would be a good choice. If the circuit must withstand a continuous shorted output, a higher current (at least 2.2A) Schottky diode is recommended.</p> <p>5. Input Capacitor (C_{IN})</p> <p>The important parameters for the input capacitor are the input voltage rating and the RMS current rating. With a maximum input voltage of 28V, an aluminum electrolytic capacitor with a voltage rating of at least 35V ($1.25 \times V_{IN}$) would be needed. The RMS current rating requirement for the input capacitor in a buck regulator is approximately ½ the DC load current. In this example, with a 1A load, a capacitor with a RMS current rating of at least 500 mA is needed. The curves shown in <i>Figure 14</i> can be used to select an appropriate input capacitor. From the curves, locate the 35V line and note which capacitor values have RMS current ratings greater than 500 mA.</p> <p>For a through hole design, a 330 μF/35V electrolytic capacitor (Panasonic HFQ series, Nichicon PL, Sanyo MV-GX series or equivalent) would be adequate. Other types or other manufacturers' capacitors can be used provided the RMS ripple current ratings are adequate. Additionally, for a complete surface mount design, electrolytic capacitors such as the Sanyo CV-C or CV-BS, and the Nichicon WF or UR and the NIC Components NACZ series could be considered.</p> <p>For surface mount designs, solid tantalum capacitors can be used, but caution must be exercised with regard to the capacitor surge current rating and voltage rating. In this example, checking <i>Figure 15</i>, and the Sprague 594D series datasheet, a Sprague 594D 15 μF, 50V capacitor is adequate.</p> <p>6. Boost Capacitor (C_B)</p> <p>For this application, and all applications, use a 0.01 μF, 50V ceramic capacitor.</p> |

LM2675 Series Buck Regulator Design Procedure (Adjustable Output)

(Continued)

| Case Style (Note 7) | Output Voltage (V) | Inductance (μH) | | | | | | |
|---------------------|--------------------|------------------------------|-----|-----|-----|-----|-----|-----|
| | | 22 | 33 | 47 | 68 | 100 | 150 | 220 |
| SM and TH | 1.21–2.50 | — | — | — | — | C1 | C2 | C3 |
| SM and TH | 2.50–3.75 | — | — | — | C1 | C2 | C3 | C3 |
| SM and TH | 3.75–5.0 | — | — | C4 | C5 | C6 | C6 | C6 |
| SM and TH | 5.0–6.25 | — | C4 | C7 | C6 | C6 | C6 | C6 |
| SM and TH | 6.25–7.5 | C8 | C4 | C7 | C6 | C6 | C6 | C6 |
| SM and TH | 7.5–10.0 | C9 | C10 | C11 | C12 | C13 | C13 | C13 |
| SM and TH | 10.0–12.5 | C14 | C11 | C12 | C12 | C13 | C13 | C13 |
| SM and TH | 12.5–15.0 | C15 | C16 | C17 | C17 | C17 | C17 | C17 |
| SM and TH | 15.0–20.0 | C18 | C19 | C20 | C20 | C20 | C20 | C20 |
| SM and TH | 20.0–30.0 | C21 | C22 | C22 | C22 | C22 | C22 | C22 |
| TH | 30.0–37.0 | C23 | C24 | C24 | C25 | C25 | C25 | C25 |

Note 7: SM - Surface Mount, TH - Through Hole

FIGURE 16. Capacitor Code Selection Guide

LM2675 Series Buck Regulator Design Procedure (Adjustable Output)

(Continued)

| Cap. Ref. Desg. # | Output Capacitor | | | | | |
|-------------------|---|------------------------------------|--|--|--|--|
| | Surface Mount | | Through Hole | | | |
| | Sprague 594D Series ($\mu\text{F/V}$) | AVX TPS Series ($\mu\text{F/V}$) | Sanyo OS-CON SA Series ($\mu\text{F/V}$) | Sanyo MV-GX Series ($\mu\text{F/V}$) | Nichicon PL Series ($\mu\text{F/V}$) | Panasonic HFQ Series ($\mu\text{F/V}$) |
| C1 | 120/6.3 | 100/10 | 100/10 | 220/35 | 220/35 | 220/35 |
| C2 | 120/6.3 | 100/10 | 100/10 | 150/35 | 150/35 | 150/35 |
| C3 | 120/6.3 | 100/10 | 100/35 | 120/35 | 120/35 | 120/35 |
| C4 | 68/10 | 100/10 | 68/10 | 220/35 | 220/35 | 220/35 |
| C5 | 100/16 | 100/10 | 100/10 | 150/35 | 150/35 | 150/35 |
| C6 | 100/16 | 100/10 | 100/10 | 120/35 | 120/35 | 120/35 |
| C7 | 68/10 | 100/10 | 68/10 | 150/35 | 150/35 | 150/35 |
| C8 | 100/16 | 100/10 | 100/10 | 330/35 | 330/35 | 330/35 |
| C9 | 100/16 | 100/16 | 100/16 | 330/35 | 330/35 | 330/35 |
| C10 | 100/16 | 100/16 | 68/16 | 220/35 | 220/35 | 220/35 |
| C11 | 100/16 | 100/16 | 68/16 | 150/35 | 150/35 | 150/35 |
| C12 | 100/16 | 100/16 | 68/16 | 120/35 | 120/35 | 120/35 |
| C13 | 100/16 | 100/16 | 100/16 | 120/35 | 120/35 | 120/35 |
| C14 | 100/16 | 100/16 | 100/16 | 220/35 | 220/35 | 220/35 |
| C15 | 47/20 | 68/20 | 47/20 | 220/35 | 220/35 | 220/35 |
| C16 | 47/20 | 68/20 | 47/20 | 150/35 | 150/35 | 150/35 |
| C17 | 47/20 | 68/20 | 47/20 | 120/35 | 120/35 | 120/35 |
| C18 | 68/25 | (2x) 33/25 | 47/25 (Note 8) | 220/35 | 220/35 | 220/35 |
| C19 | 33/25 | 33/25 | 33/25 (Note 8) | 150/35 | 150/35 | 150/35 |
| C20 | 33/25 | 33/25 | 33/25 (Note 8) | 120/35 | 120/35 | 120/35 |
| C21 | 33/35 | (2x) 22/25 | (Note 9) | 150/35 | 150/35 | 150/35 |
| C22 | 33/35 | 22/35 | (Note 9) | 120/35 | 120/35 | 120/35 |
| C23 | (Note 9) | (Note 9) | (Note 9) | 220/50 | 100/50 | 120/50 |
| C24 | (Note 9) | (Note 9) | (Note 9) | 150/50 | 100/50 | 120/50 |
| C25 | (Note 9) | (Note 9) | (Note 9) | 150/50 | 82/50 | 82/50 |

Note 8: The SC series of Os-Con capacitors (others are SA series)

Note 9: The voltage ratings of the surface mount tantalum chip and Os-Con capacitors are too low to work at these voltages.

FIGURE 17. Output Capacitor Selection Table

Application Information

TYPICAL SURFACE MOUNT PC BOARD LAYOUT, FIXED OUTPUT (4X SIZE)

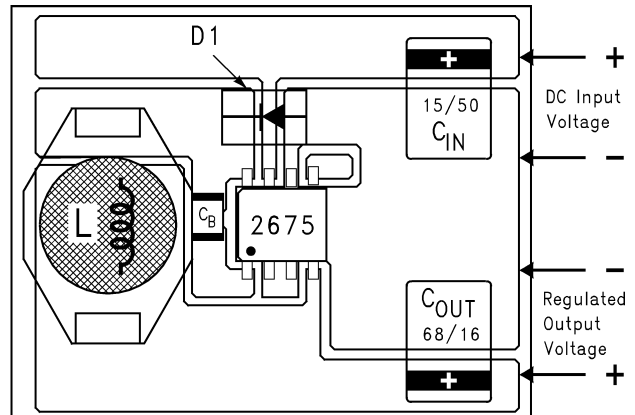
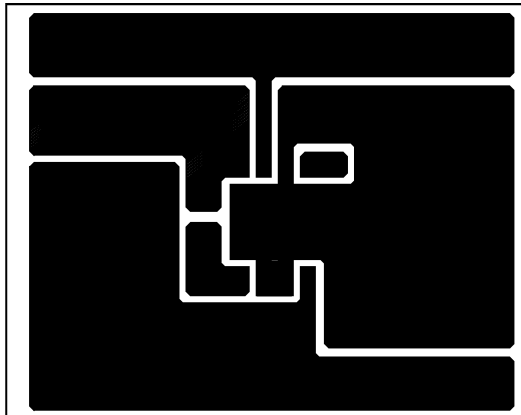

01280336

C_{IN} - 15 μ F, 50V, Solid Tantalum Sprague, "594D series"
 C_{OUT} - 68 μ F, 16V, Solid Tantalum Sprague, "594D series"
 D1 - 1A, 40V Schottky Rectifier, Surface Mount
 L1 - 33 μ H, L23, Coilcraft DO3316
 C_B - 0.01 μ F, 50V, Ceramic

TYPICAL SURFACE MOUNT PC BOARD LAYOUT, ADJUSTABLE OUTPUT (4X SIZE)

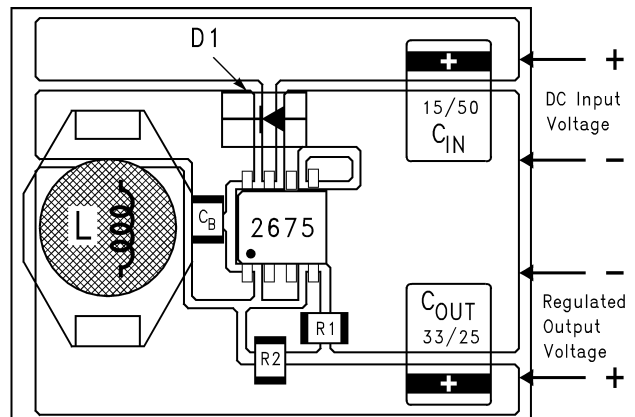
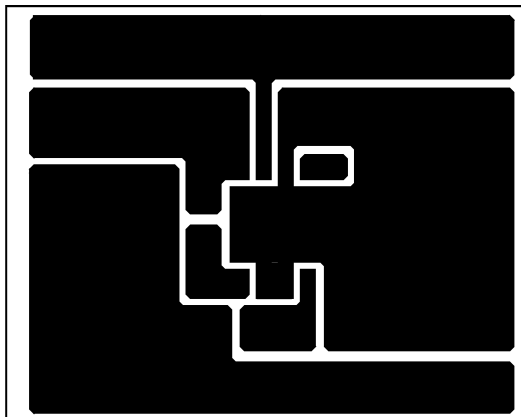

01280337

C_{IN} - 15 μ F, 50V, Solid Tantalum Sprague, "594D series"
 C_{OUT} - 33 μ F, 25V, Solid Tantalum Sprague, "594D series"
 D1 - 1A, 40V Schottky Rectifier, Surface Mount
 L1 - 68 μ H, L30, Coilcraft DO3316
 C_B - 0.01 μ F, 50V, Ceramic
 R1 - 1k, 1%
 R2 - Use formula in Design Procedure

FIGURE 18. PC Board Layout

Layout is very important in switching regulator designs. Rapidly switching currents associated with wiring inductance can generate voltage transients which can cause problems. For minimal inductance and ground loops, the wires indicated by **heavy lines (in Figure 2 and Figure 3)** should be wide printed circuit traces and should be kept as short as

possible. For best results, external components should be located as close to the switcher IC as possible using ground plane construction or single point grounding.

If **open core inductors are used**, special care must be taken as to the location and positioning of this type of inductor. Allowing the inductor flux to intersect sensitive feedback, IC ground path, and C_{OUT} wiring can cause problems.

Application Information (Continued)

When using the adjustable version, special care must be taken as to the location of the feedback resistors and the associated wiring. Physically locate both resistors near the IC, and route the wiring away from the inductor, especially an open core type of inductor.

LLP PACKAGE DEVICES

The LM2675 is offered in the 16 lead LLP surface mount package to allow for increased power dissipation compared to the SO-8 and DIP.

The Die Attach Pad (DAP) can and should be connected to PCB Ground plane/island. For CAD and assembly guidelines refer to Application Note AN-1187 at <http://power.national.com>.

Physical Dimensions inches (millimeters)

unless otherwise noted

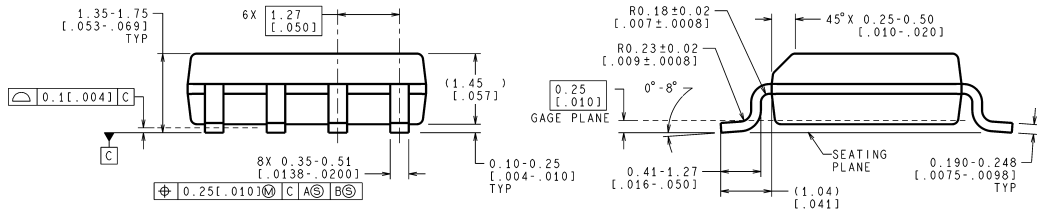
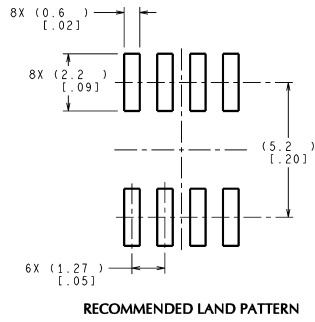
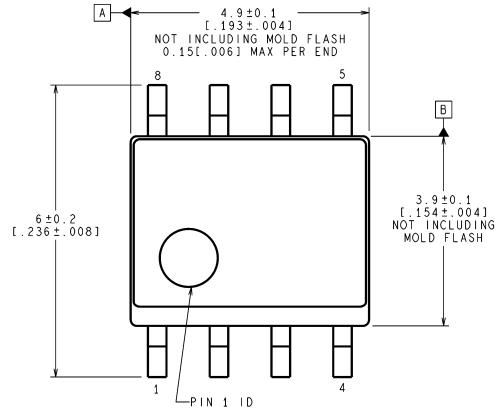

CONTROLLING DIMENSION IS MILLIMETER
 VALUES IN [] ARE INCHES
 DIMENSIONS IN () FOR REFERENCE ONLY

M08A (Rev K)

8-Lead (0.150" Wide) Molded Small Outline Package, JEDEC
Order Number LM2675M-3.3, LM2675M-5.0,
LM2675M-12 or LM2675M-ADJ
NS Package Number M08A

Physical Dimensions inches (millimeters) unless otherwise noted (Continued)

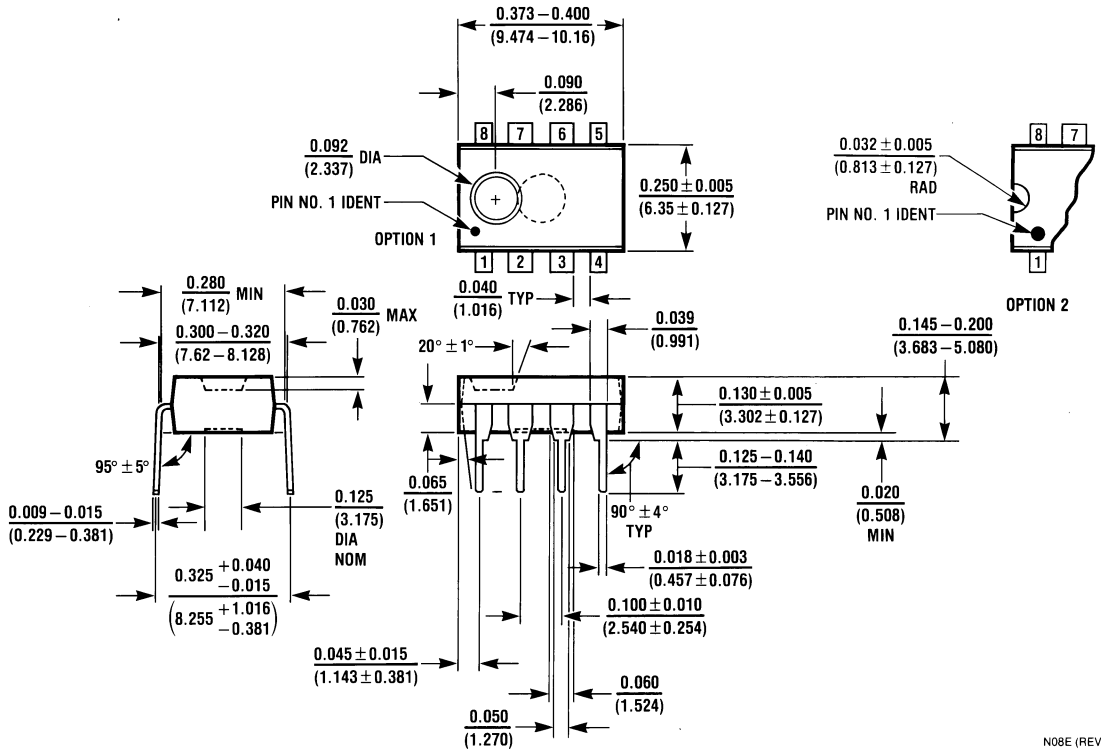

8-Lead (0.300" Wide) Molded Dual-In-Line Package
Order Number LM2675N-3.3, LM2675N-5.0,
LM2675N-12 or LM2675N-ADJ
NS Package Number N08E

N08E (REV F)

Physical Dimensions inches (millimeters) unless otherwise noted (Continued)

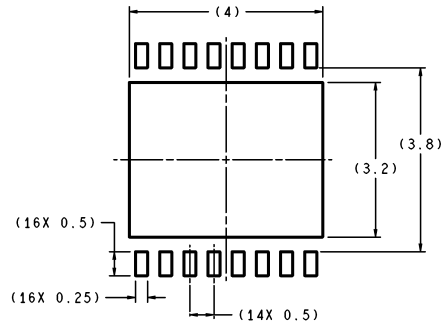

DIMENSIONS ARE IN MILLIMETERS

RECOMMENDED LAND PATTERN
1:1 RATIO WITH PKG SOLDER PADS

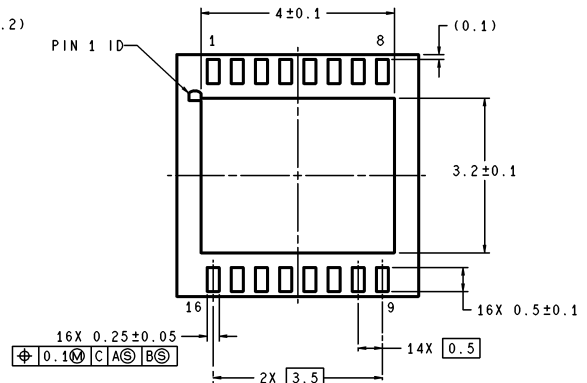
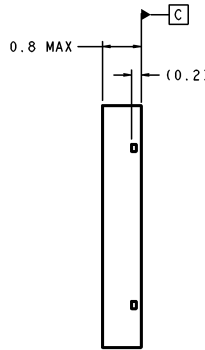
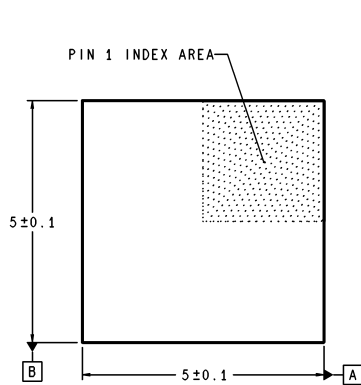

LDA16A (Rev A)

**16-Lead LLP Surface Mount Package
NS Package Number LDA16A**

National does not assume any responsibility for use of any circuitry described, no circuit patent licenses are implied and National reserves the right at any time without notice to change said circuitry and specifications.

For the most current product information visit us at www.national.com.

LIFE SUPPORT POLICY

NATIONAL'S PRODUCTS ARE NOT AUTHORIZED FOR USE AS CRITICAL COMPONENTS IN LIFE SUPPORT DEVICES OR SYSTEMS WITHOUT THE EXPRESS WRITTEN APPROVAL OF THE PRESIDENT AND GENERAL COUNSEL OF NATIONAL SEMICONDUCTOR CORPORATION. As used herein:

1. Life support devices or systems are devices or systems which, (a) are intended for surgical implant into the body, or (b) support or sustain life, and whose failure to perform when properly used in accordance with instructions for use provided in the labeling, can be reasonably expected to result in a significant injury to the user.
2. A critical component is any component of a life support device or system whose failure to perform can be reasonably expected to cause the failure of the life support device or system, or to affect its safety or effectiveness.

BANNED SUBSTANCE COMPLIANCE

National Semiconductor manufactures products and uses packing materials that meet the provisions of the Customer Products Stewardship Specification (CSP-9-111C2) and the Banned Substances and Materials of Interest Specification (CSP-9-111S2) and contain no "Banned Substances" as defined in CSP-9-111S2.

Leadfree products are RoHS compliant.



National Semiconductor
Americas Customer
Support Center
Email: new.feedback@nsc.com
Tel: 1-800-272-9959

National Semiconductor
Europe Customer Support Center
Fax: +49 (0) 180-530 85 86
Email: europe.support@nsc.com
Deutsch Tel: +49 (0) 69 9508 6208
English Tel: +44 (0) 870 24 0 2171
Français Tel: +33 (0) 1 41 91 8790

National Semiconductor
Asia Pacific Customer
Support Center
Email: ap.support@nsc.com

National Semiconductor
Japan Customer Support Center
Fax: 81-3-5639-7507
Email: jpn.feedback@nsc.com
Tel: 81-3-5639-7560