

---

# HA13153A, HA13154A

15 W × 4-Channel BTL Power IC

## HITACHI

ADE-207-181B (Z)  
3rd Edition  
Jul. 1999

---

### Description

The HA13153A/HA13154A is high output and low distortion 4 ch BTL power IC designed for digital car audio.

At 13.2 V to 4 Ω load, this power IC provides output power 15 W with 10% distortion.

### Function

- 4 ch BTL power amplifiers
- Built-in standby circuit
- Built-in muting circuit
- Built-in protection circuit (surge, T.S.D, and ASO)

### Features

- Few external parts lead to compact set-area possibility than HA13150A/HA13151/HA13152 (C: 3, R: 1)
- Popping noise minimized
- Low output noise
- Built-in high reliability protection circuit
- Pin to pin with HA13150A/HA13151/HA13152/HA13155

## Block Diagram

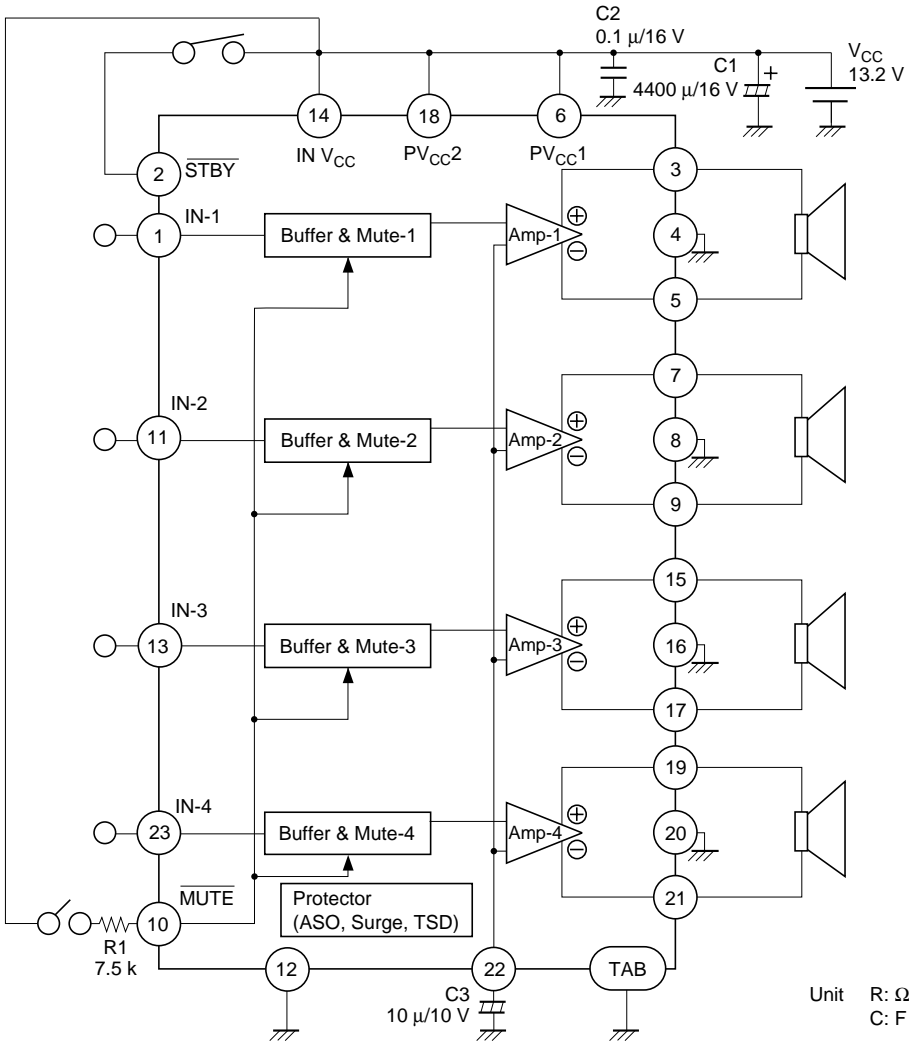

C2 should be polyester film capacitors with no secondary resonance (non-inductive), to assure stable operation.

**Notes:** 1. Standby

Power is turned on when a signal of 3.5 V or 0.05 mA is impressed at pin 2. When pin 2 is open or connected to GND, standby is turned on (output off).

2. Muting

Muting is turned off (output on) when a signal of 3.5 V or 0.2 mA is impressed at pin 10. When pin 10 is open or connected to GND, muting is turned on (output off).

3. TAB (header of IC) connected to GND.

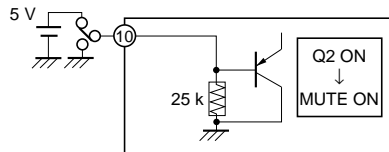
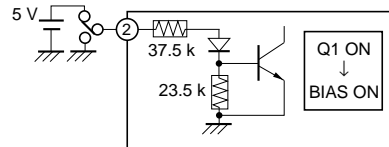

**Absolute Maximum Ratings**

Item	Symbol	Rating	Unit
Operating supply voltage	$V_{CC}$	18	V
Supply voltage when no signal* <sup>1</sup>	$V_{CC}$ (DC)	26	V
Peak supply voltage* <sup>2</sup>	$V_{CC}$ (PEAK)	50	V
Output current* <sup>3</sup>	$I_o$ (PEAK)	3	A
Power dissipation* <sup>4</sup>	$P_T$	83	W
Junction temperature	$T_j$	150	°C
Operating temperature	$T_{opr}$	-30 to +85	°C
Storage temperature	$T_{stg}$	-55 to +125	°C

- Notes: 1. Tolerance within 30 seconds.  
 2. Tolerance in surge pulse waveform.  
 3. Value per 1 channel.  
 4. Value when attached on the infinite heat sink plate at  $T_a = 25\text{ °C}$ .  
 The derating curve is as shown in the graph below.

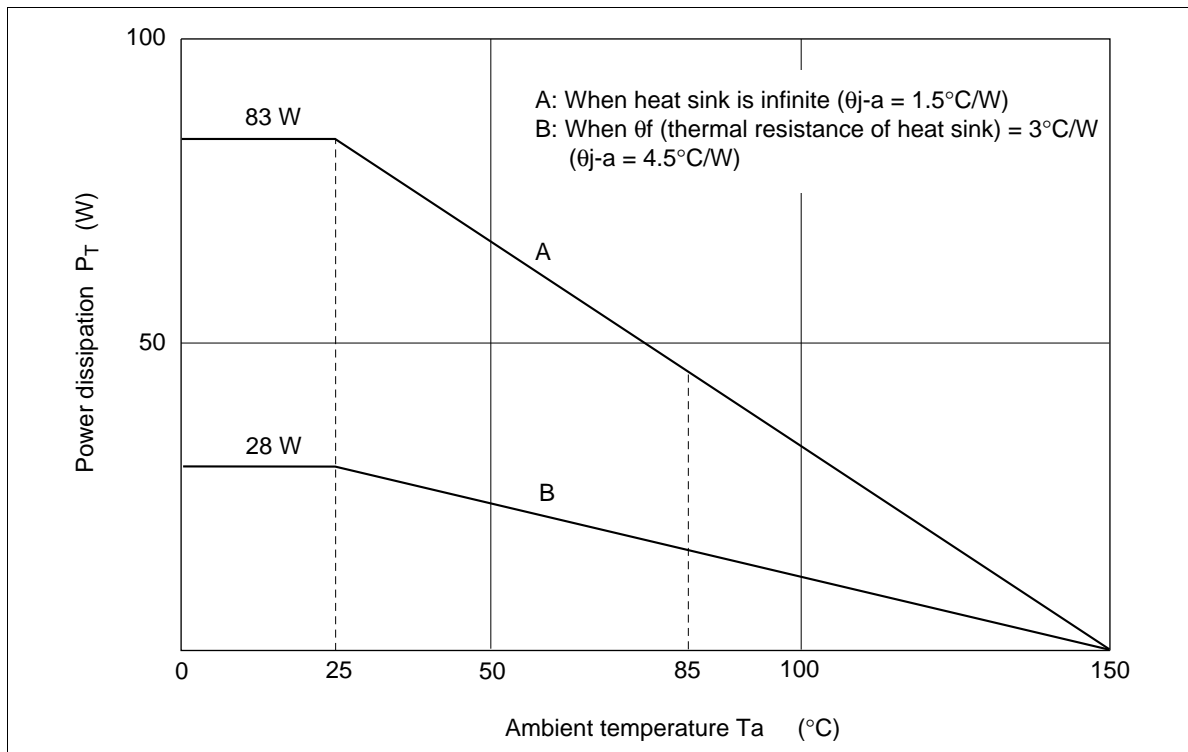

# HA13153A, HA13154A

**Electrical Characteristics** ( $V_{CC} = 13.2 \text{ V}$ ,  $f = 1 \text{ kHz}$ ,  $R_L = 4 \Omega$ ,  $R_g = 600 \Omega$ ,  $T_a = 25^\circ\text{C}$ )

## HA13153A

Item	Symbol	Min	Typ	Max	Unit	Test Conditions
Quiescent current	$I_{Q1}$	—	350	—	mA	$V_{in} = 0$
Output offset voltage	$\Delta V_Q$	-300	0	+300	mV	
Gain	$G_V$	30.5	32	33.5	dB	
Gain difference between channels	$\Delta G_V$	-1.0	0	+1.0	dB	
Rated output power	$P_o$	—	15	—	W	$V_{CC} = 13.2 \text{ V}$ THD = 10%, $R_L = 4 \Omega$
Max output power	$P_{o\max}$	—	25	—	W	$V_{CC} = 13.7 \text{ V}$ , $R_L = 4 \Omega$
Total harmonic distortion	T.H.D.	—	0.02	—	%	$P_o = 3 \text{ W}$
Output noise voltage	WBN	—	0.15	—	mVrms	$R_g = 0 \Omega$ BW = 20 to 20 kHz
Ripple rejection	SVR	—	55	—	dB	$R_g = 600 \Omega$ , $f = 120 \text{ Hz}$
Channel cross talk	C.T.	—	70	—	dB	$R_g = 600 \Omega$ $V_{out} = 0 \text{ dBm}$
Input impedance	$R_{in}$	—	25	—	k $\Omega$	
Standby current	$I_{Q2}$	—	—	10	$\mu\text{A}$	
Standby control voltage (high)	$V_{STH}$	3.5	—	$V_{CC}$	V	
Standby control voltage (low)	$V_{STL}$	0	—	1.5	V	
Muting control voltage (high)	$V_{MH}$	3.5	—	$V_{CC}$	V	
Muting control voltage (low)	$V_{ML}$	0	—	1.5	V	
Muting attenuation	ATTM	—	70	—	dB	$V_{out} = 0 \text{ dBm}$

**HA13154A**

<b>Item</b>	<b>Symbol</b>	<b>Min</b>	<b>Typ</b>	<b>Max</b>	<b>Unit</b>	<b>Test Conditions</b>
Quiescent current	$I_{Q1}$	—	350	—	mA	$V_{in} = 0$
Output offset voltage	$\Delta V_Q$	-300	0	+300	mV	
Gain	$G_V$	38.5	40	41.5	dB	
Gain difference between channels	$\Delta G_V$	-1.0	0	+1.0	dB	
Rated output power	$P_o$	—	15	—	W	$V_{CC} = 13.2\text{ V}$ THD = 10%, $R_L = 4\ \Omega$
Max output power	$P_{o\max}$	—	25	—	W	$V_{CC} = 13.7\text{ V}$ , $R_L = 4\ \Omega$
Total harmonic distortion	T.H.D.	—	0.02	—	%	$P_o = 3\text{ W}$
Output noise voltage	WBN	—	0.25	—	mVrms	$R_g = 0\ \Omega$ BW = 20 to 20 kHz
Ripple rejection	SVR	—	45	—	dB	$R_g = 600\ \Omega$ , $f = 120\text{ Hz}$
Channel cross talk	C.T.	—	60	—	dB	$R_g = 600\ \Omega$ $V_{out} = 0\text{ dBm}$
Input impedance	$R_{in}$	—	25	—	k $\Omega$	
Standby current	$I_{Q2}$	—	—	10	$\mu\text{A}$	
Standby control voltage (high)	$V_{STH}$	3.5	—	$V_{CC}$	V	
Standby control voltage (low)	$V_{STL}$	0	—	1.5	V	
Muting control voltage (high)	$V_{MH}$	3.5	—	$V_{CC}$	V	
Muting control voltage (low)	$V_{ML}$	0	—	1.5	V	
Muting attenuation	ATTM	—	60	—	dB	$V_{out} = 0\text{ dBm}$

Characteristics Curve

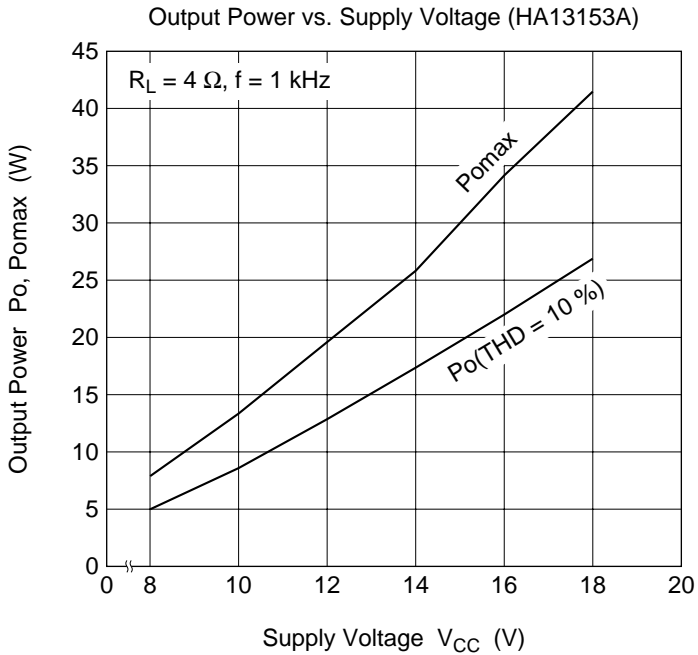
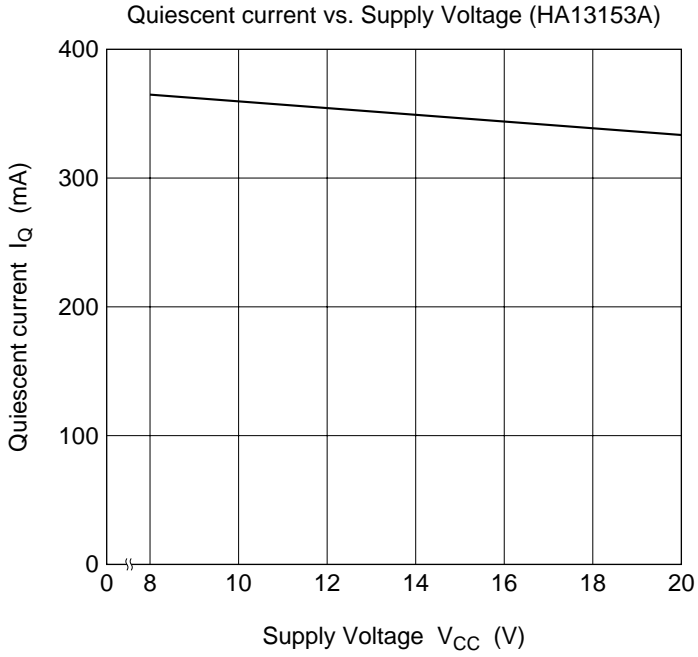

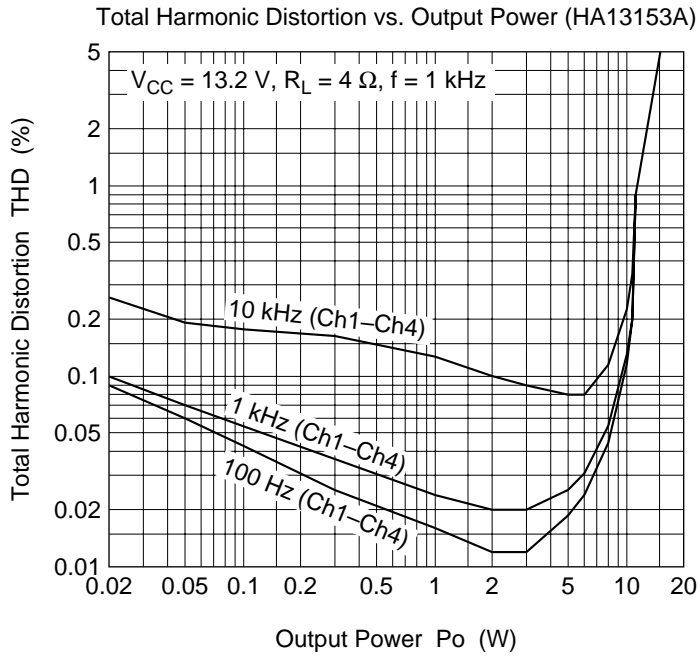
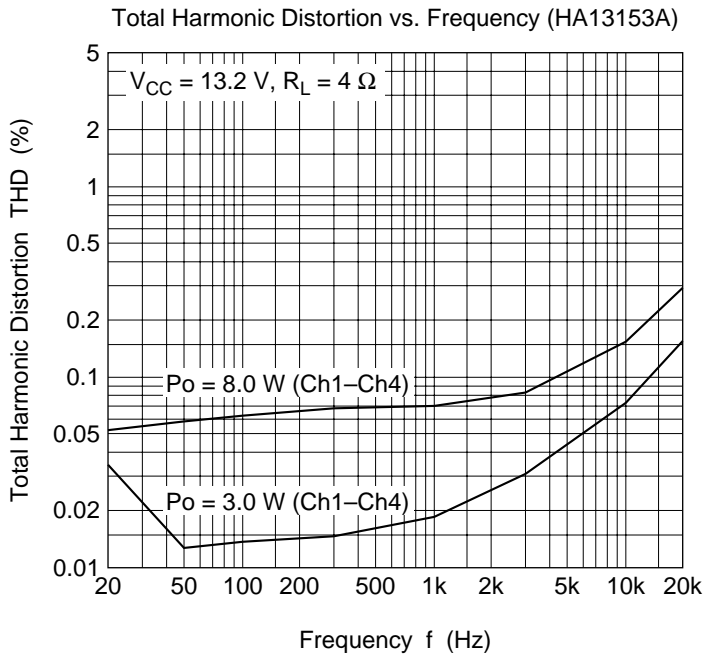

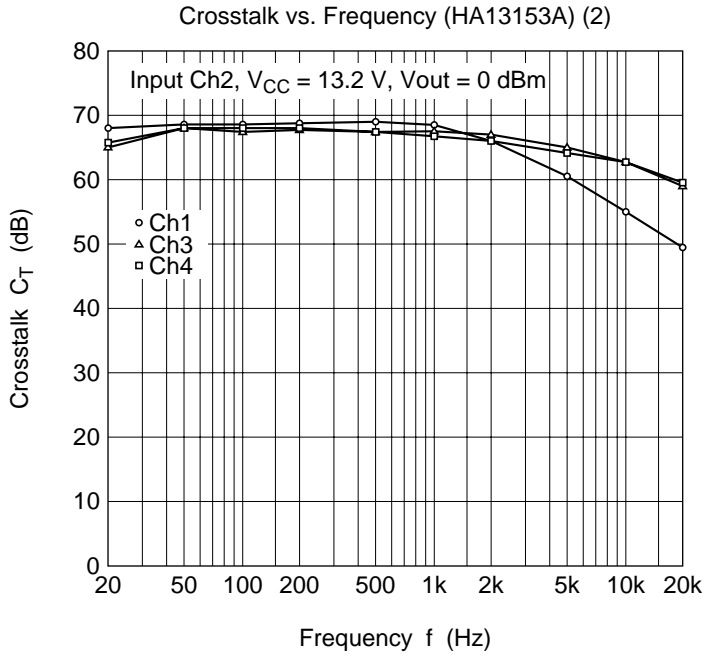
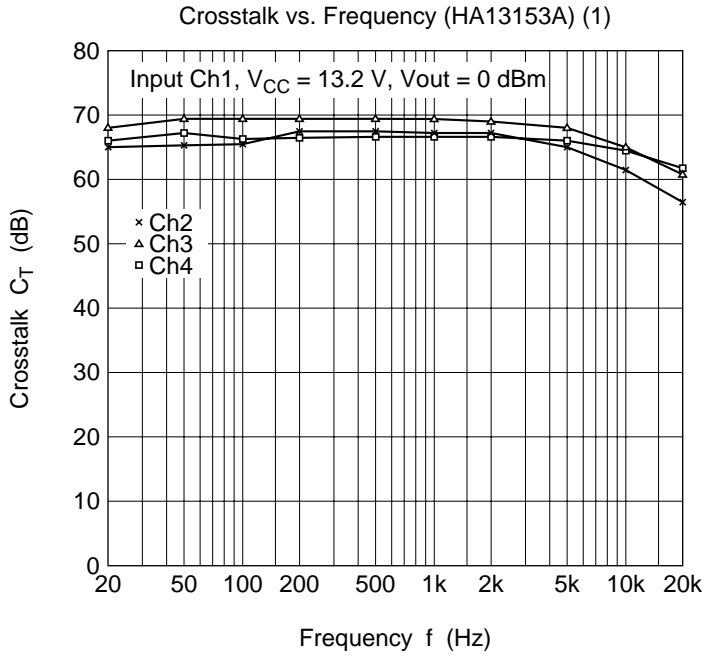



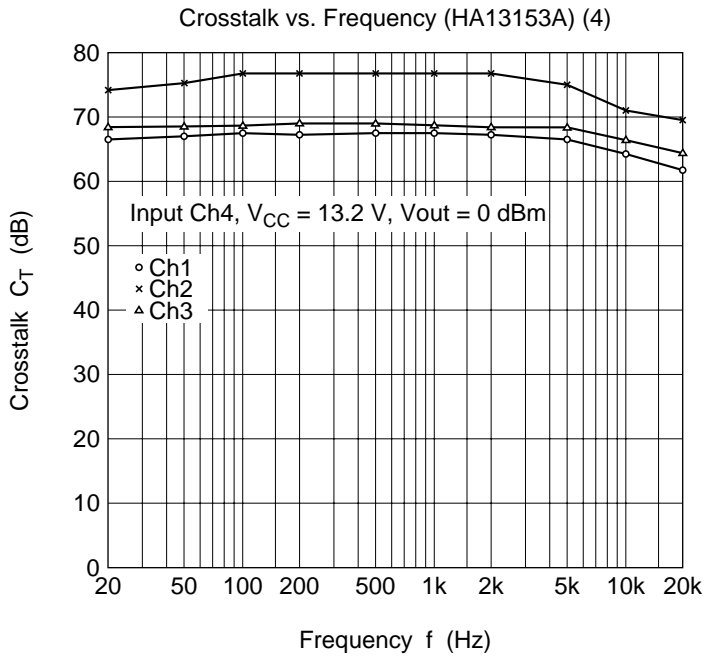
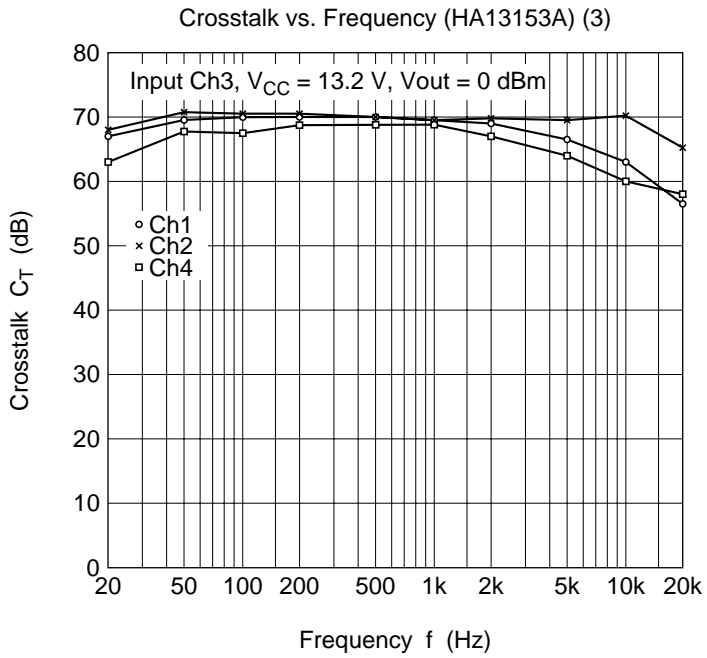

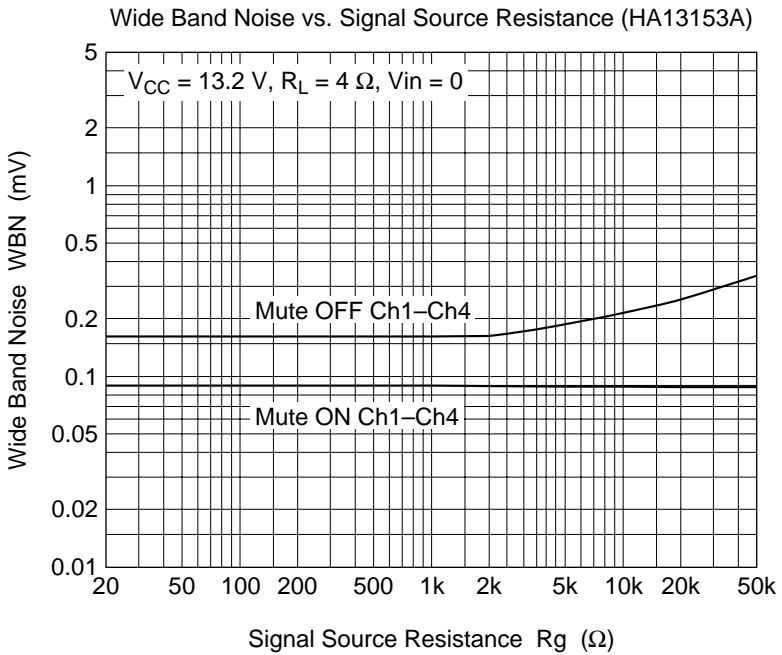
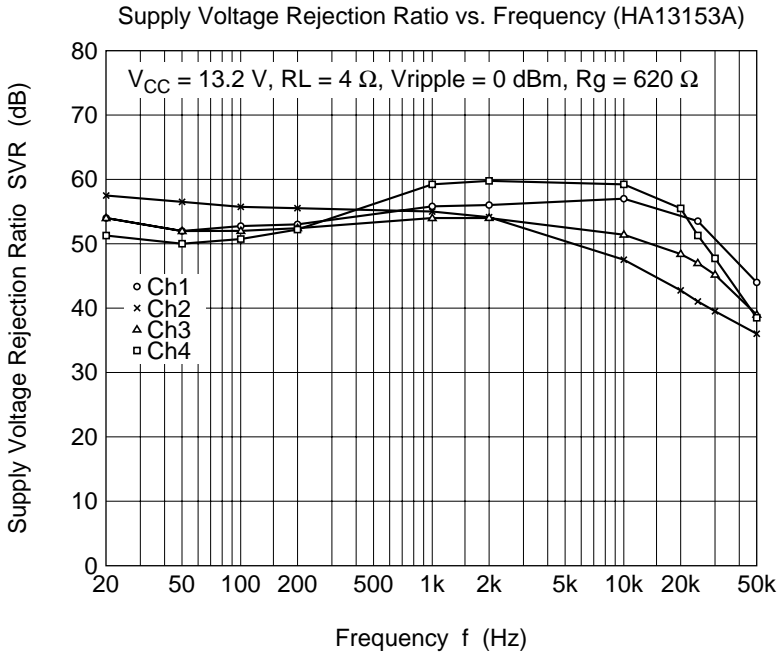

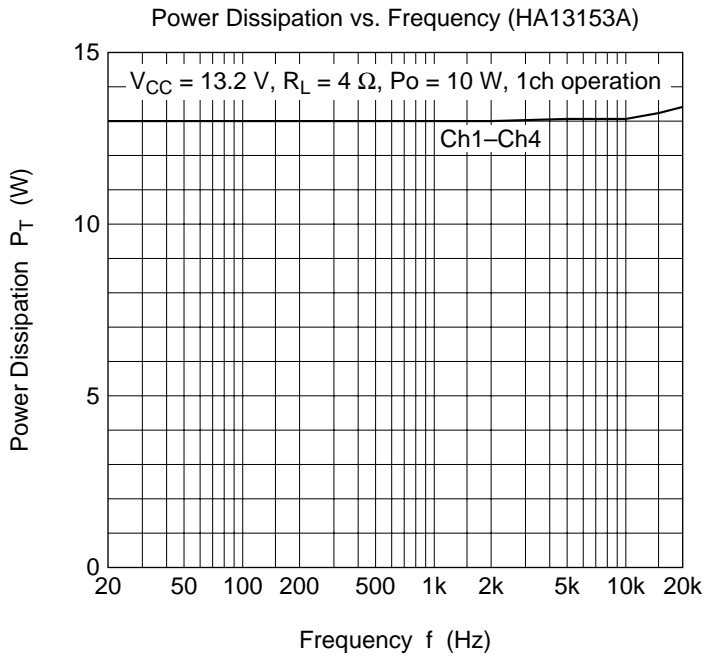
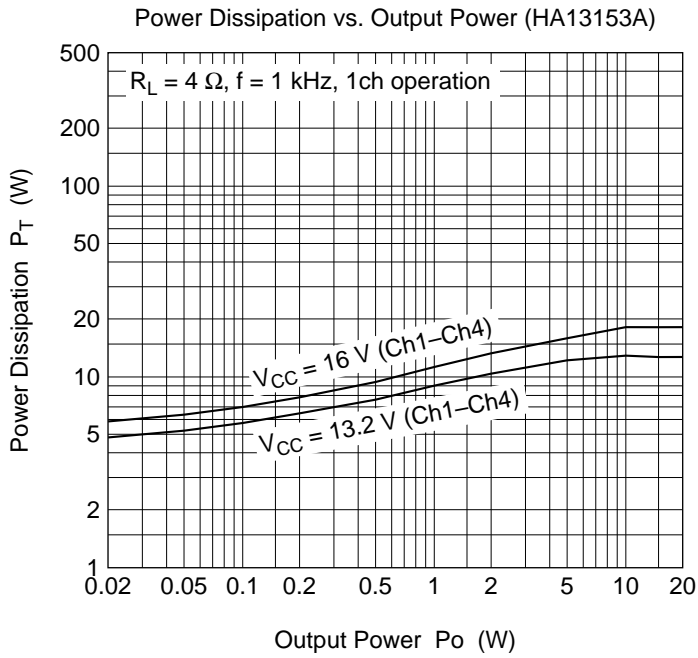

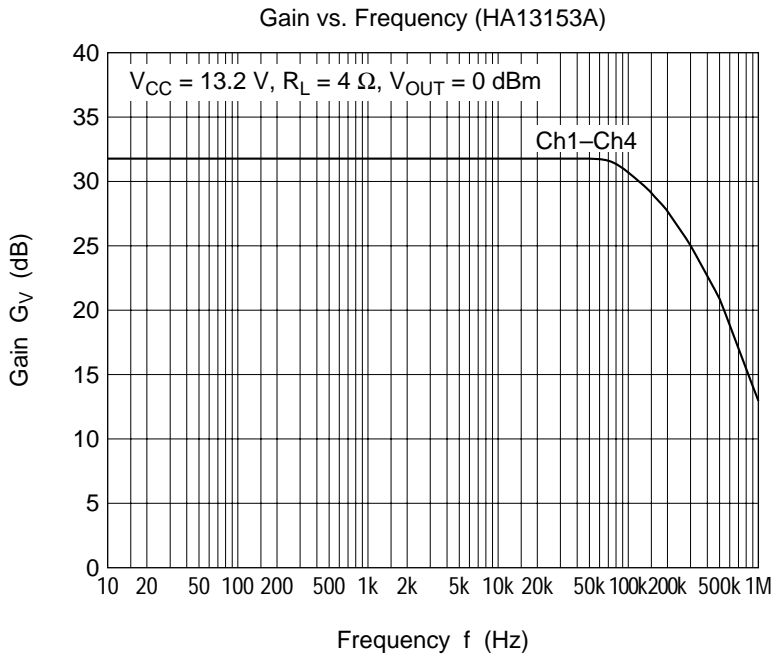

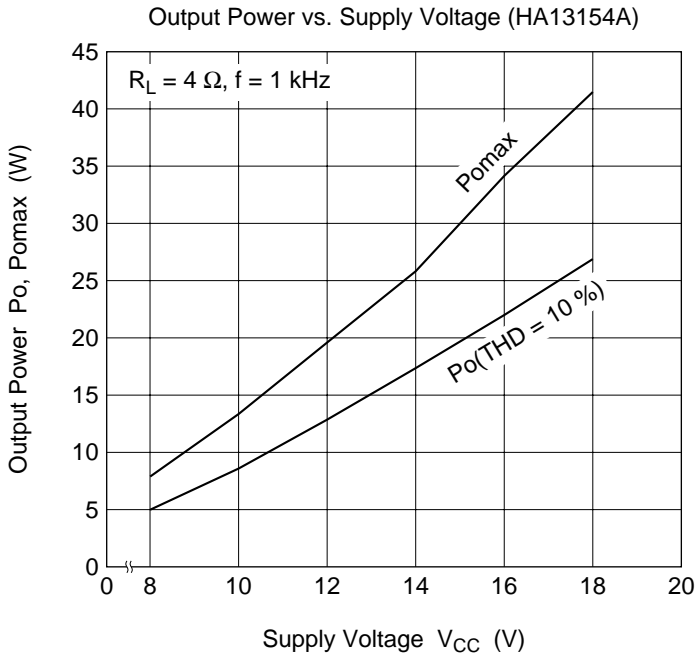
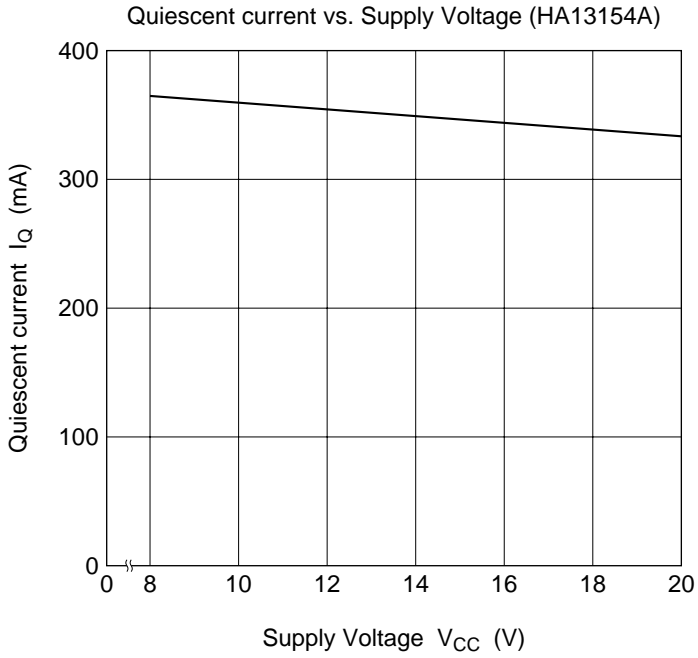

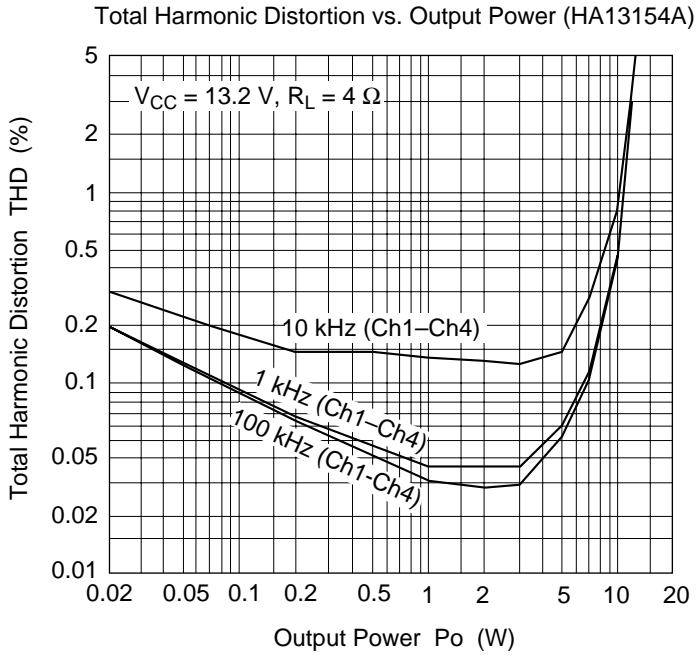
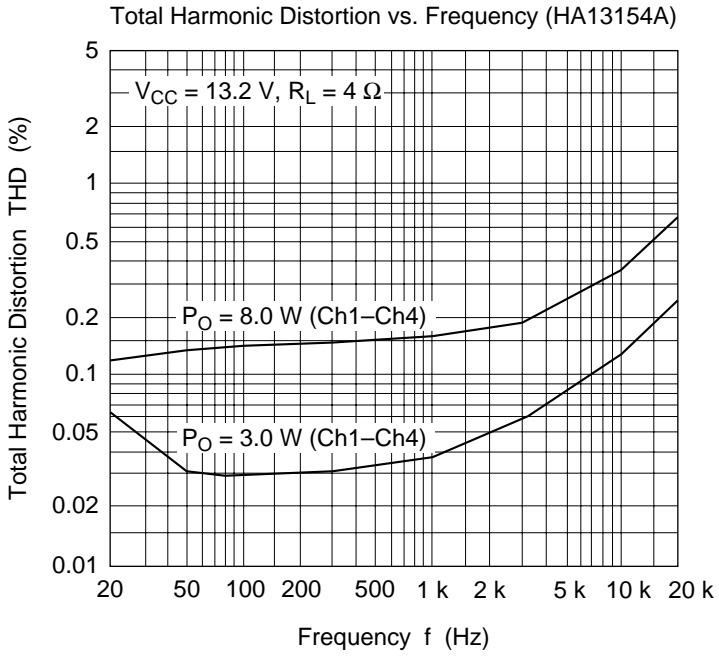

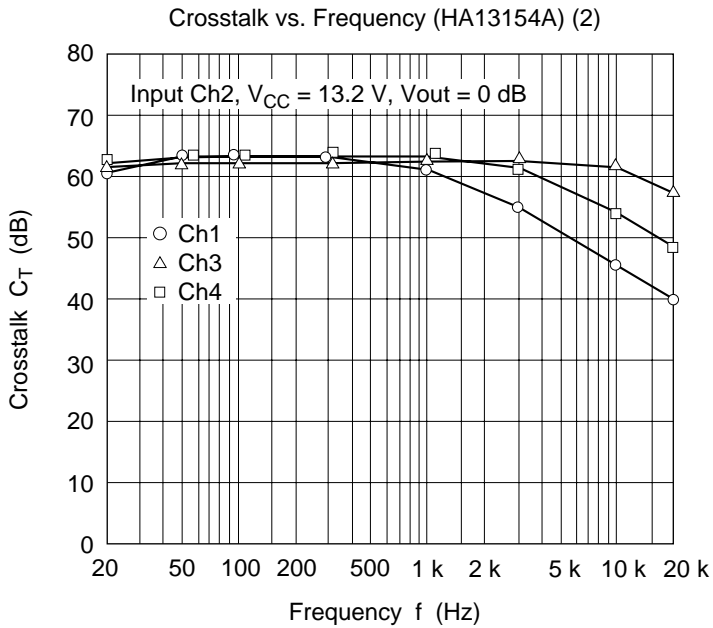
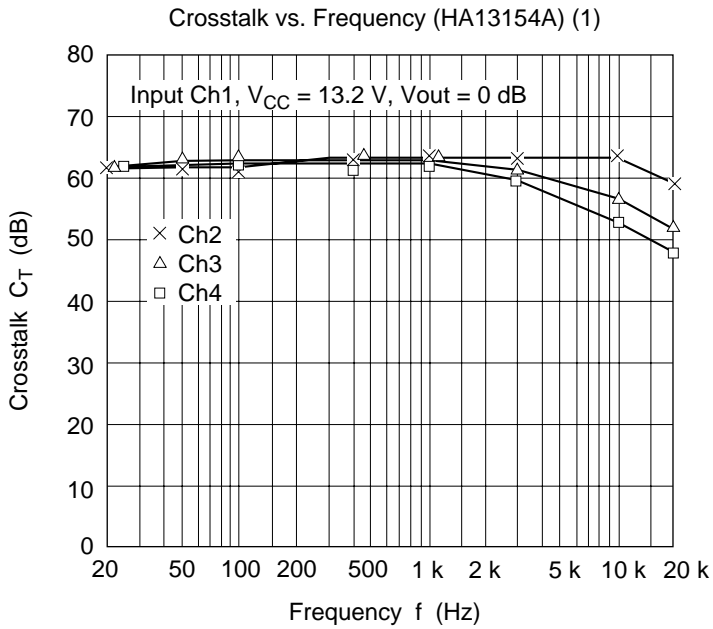

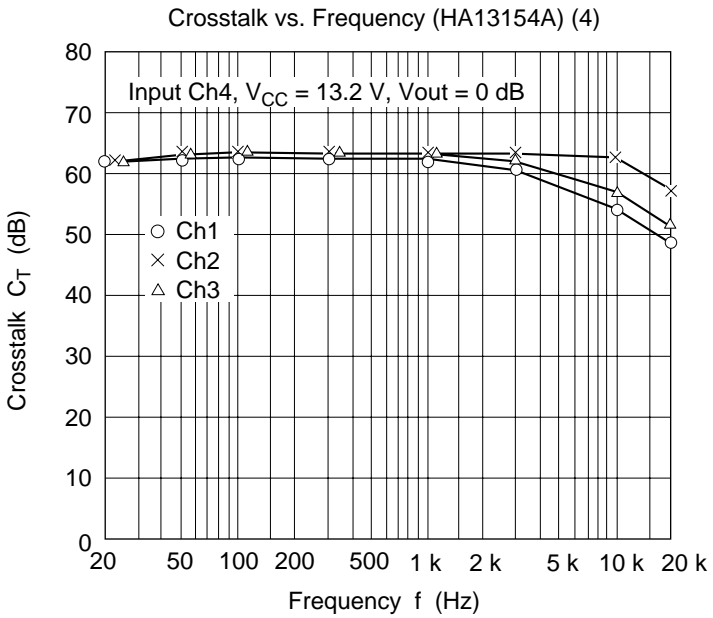
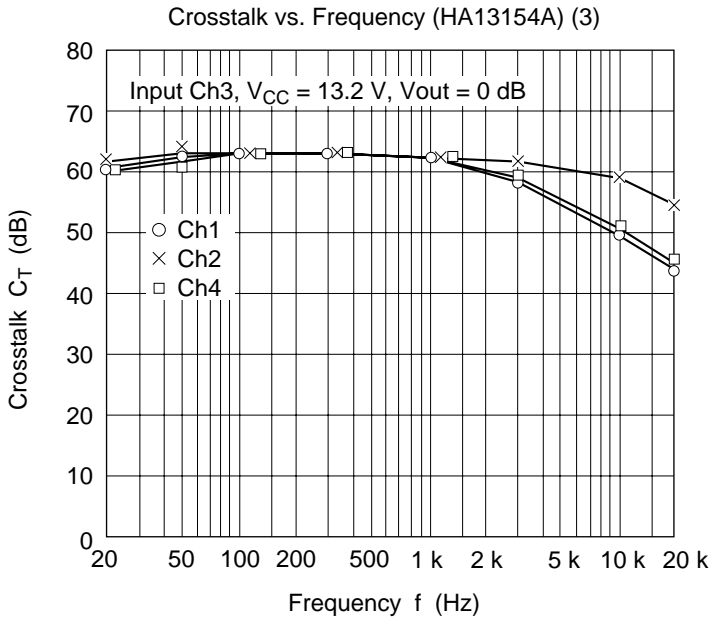



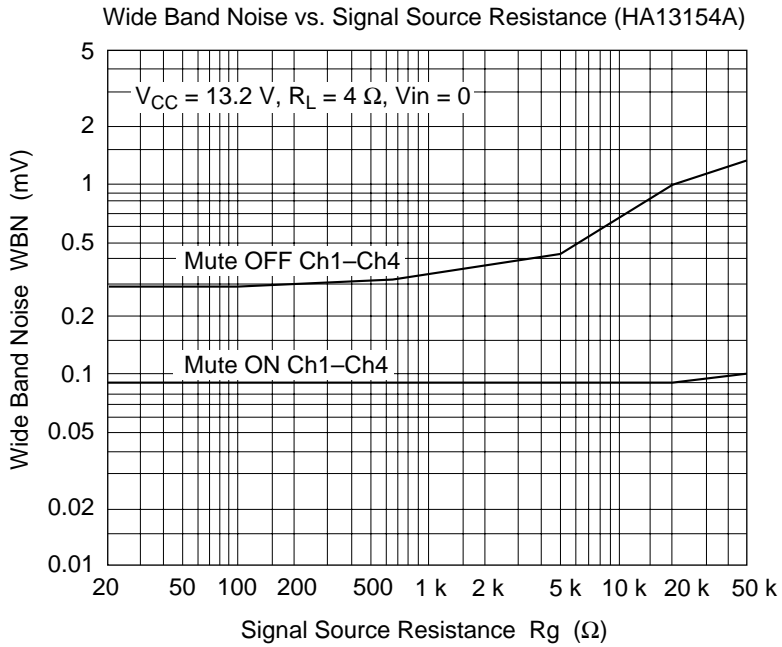
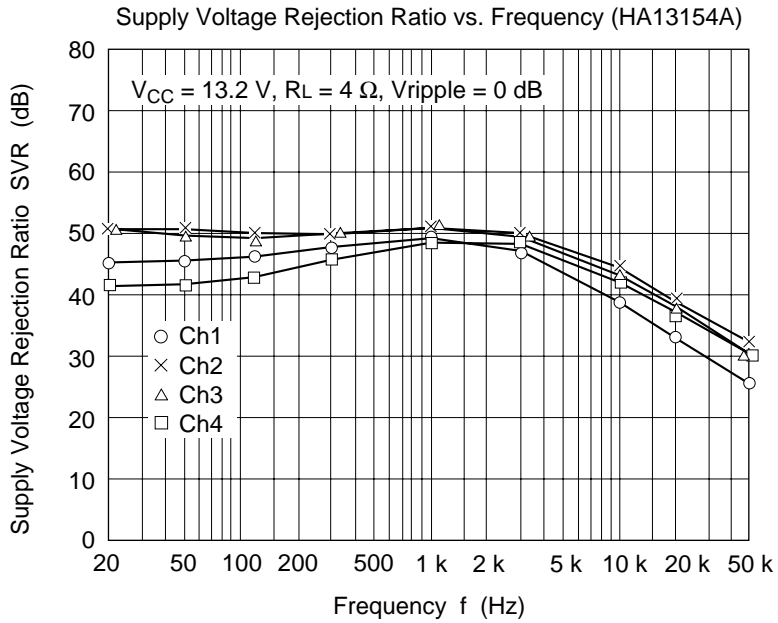

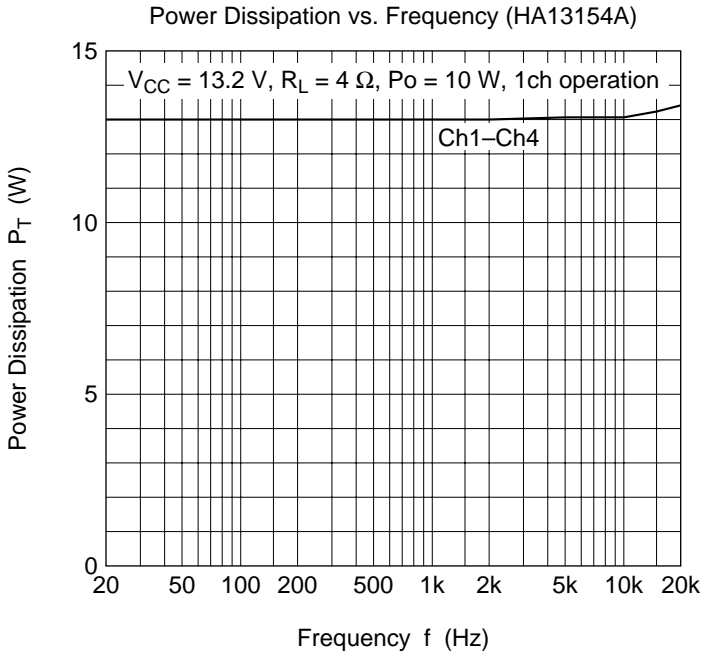
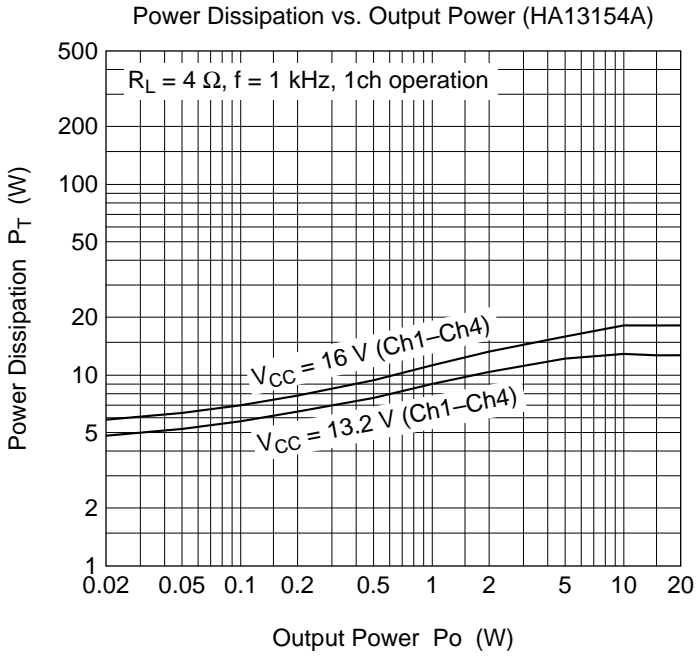

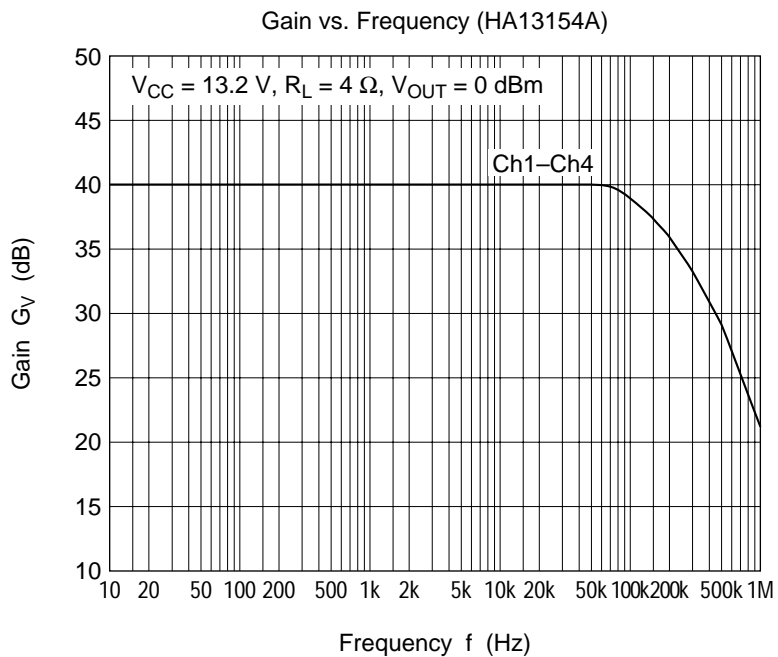

Package Dimensions

Unit: mm

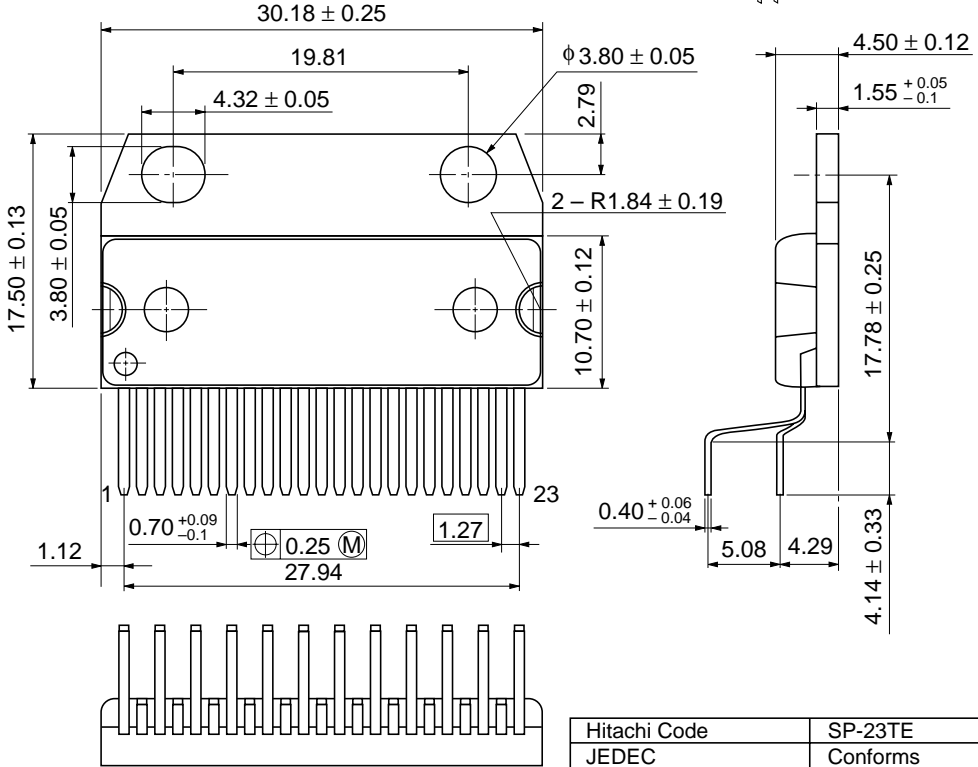
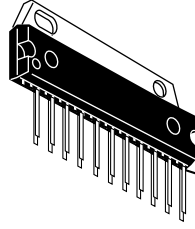

Hitachi Code	SP-23TE
JEDEC	Conforms
EIAJ	—
Weight (reference value)	8.5 g

**Cautions**

1. Hitachi neither warrants nor grants licenses of any rights of Hitachi's or any third party's patent, copyright, trademark, or other intellectual property rights for information contained in this document. Hitachi bears no responsibility for problems that may arise with third party's rights, including intellectual property rights, in connection with use of the information contained in this document.
2. Products and product specifications may be subject to change without notice. Confirm that you have received the latest product standards or specifications before final design, purchase or use.
3. Hitachi makes every attempt to ensure that its products are of high quality and reliability. However, contact Hitachi's sales office before using the product in an application that demands especially high quality and reliability or where its failure or malfunction may directly threaten human life or cause risk of bodily injury, such as aerospace, aeronautics, nuclear power, combustion control, transportation, traffic, safety equipment or medical equipment for life support.
4. Design your application so that the product is used within the ranges guaranteed by Hitachi particularly for maximum rating, operating supply voltage range, heat radiation characteristics, installation conditions and other characteristics. Hitachi bears no responsibility for failure or damage when used beyond the guaranteed ranges. Even within the guaranteed ranges, consider normally foreseeable failure rates or failure modes in semiconductor devices and employ systemic measures such as fail-safes, so that the equipment incorporating Hitachi product does not cause bodily injury, fire or other consequential damage due to operation of the Hitachi product.
5. This product is not designed to be radiation resistant.
6. No one is permitted to reproduce or duplicate, in any form, the whole or part of this document without written approval from Hitachi.
7. Contact Hitachi's sales office for any questions regarding this document or Hitachi semiconductor products.

# HITACHI

**Hitachi, Ltd.**

Semiconductor & Integrated Circuits.  
 Nippon Bldg., 2-6-2, Ohte-machi, Chiyoda-ku, Tokyo 100-0004, Japan  
 Tel: Tokyo (03) 3270-2111 Fax: (03) 3270-5109

URL      North America      : <http://semiconductor.hitachi.com/>  
              Europe                 : <http://www.hitachi-eu.com/hel/ecg>  
              Asia (Singapore)      : <http://www.has.hitachi.com.sg/grp3/sicd/index.htm>  
              Asia (Taiwan)            : [http://www.hitachi.com.tw/E/Product/SICD\\_Frame.htm](http://www.hitachi.com.tw/E/Product/SICD_Frame.htm)  
              Asia (HongKong)        : <http://www.hitachi.com.hk/eng/bo/grp3/index.htm>  
              Japan                        : <http://www.hitachi.co.jp/Sicd/indx.htm>

**For further information write to:**

Hitachi Semiconductor  
 (America) Inc.  
 179 East Tasman Drive,  
 San Jose, CA 95134  
 Tel: <1> (408) 433-1990  
 Fax: <1>(408) 433-0223

Hitachi Europe GmbH  
 Electronic components Group  
 Dornacher Straße 3  
 D-85622 Feldkirchen, Munich  
 Germany  
 Tel: <49> (89) 9 9180-0  
 Fax: <49> (89) 9 29 30 00

Hitachi Europe Ltd.  
 Electronic Components Group.  
 Whitebrook Park  
 Lower Cookham Road  
 Maidenhead  
 Berkshire SL6 8YA, United Kingdom  
 Tel: <44> (1628) 585000  
 Fax: <44> (1628) 778322

Hitachi Asia Pte. Ltd.  
 16 Collyer Quay #20-00  
 Hitachi Tower  
 Singapore 049318  
 Tel: 535-2100  
 Fax: 535-1533

Hitachi Asia Ltd.  
 Taipei Branch Office  
 3F, Hung Kuo Building, No.167,  
 Tun-Hwa North Road, Taipei (105)  
 Tel: <886> (2) 2718-3666  
 Fax: <886> (2) 2718-8180

Hitachi Asia (Hong Kong) Ltd.  
 Group III (Electronic Components)  
 7/F., North Tower, World Finance Centre,  
 Harbour City, Canton Road, Tsim Sha Tsui,  
 Kowloon, Hong Kong  
 Tel: <852> (2) 735 9218  
 Fax: <852> (2) 730 0281  
 Telex: 40815 HITEC HX

Copyright ' Hitachi, Ltd., 1998. All rights reserved. Printed in Japan.