HA13119

Dual 5.5 W Audio Power Amplifier

HITACHI

Description

The HA13119 is power IC designed for car radio and car stereo amplifiers. At 13.2 V to 4 Ω load, this power IC provides output power of 5.5 W with 10 % distortion.

It is easy to design as this IC employs internal each protection circuit and the new small package.

Features

- Low distortion
THD = 0.1% typ
($P_o = 0.5$ W, $f = 100$ Hz to 10 kHz)
THD = 1% typ
($P_o = 3$ W, $f = 70$ Hz to 40 kHz)
- Internal each protection circuits
 - Surge protection circuit (more than 50 V)
 - Thermal shut-down circuit
 - Ground fault protection circuit
 - Power supply fault protection circuit
- Low external components count

HA13119

Absolute Maximum Ratings (Ta = 25°C)

Item	Symbol	Rating	Unit	Note
Operating supply voltage	V _{CC}	18	V	
DC supply voltage	V _{CC} (DC)	26	V	1
Peak supply voltage	V _{CC} (peak)	50	V	2
Output current	I _o (peak)	4	A	3
Power dissipation	P _T	15	W	4
Thermal resistance	j - c	3.5	°C/W	
Junction temperature	T _j	150	°C	
Operating temperature	T _{opr}	-30 to +80	°C	
Storage temperature	T _{stg}	-55 to +125	°C	

Notes: 1. Value at t = 30 sec.

2. Value at width tw = 200 ms and rise time tr = 1 ms.

3. Per channel

4. Per package

Electrical Characteristics (V_{CC} = 13.2 V, f = 1 kHz, R_L = 4 Ω, Ta = 25°C)

1 channel operation

Item	Symbol	Min	Typ	Max	Unit	Test Conditions
Quiescent current	I _Q	—	80	160	mA	V _{in} = 0 V
Input bias voltage	V _B	—	—	10	mV	V _{in} = 0 V, R _g = 10 k
Voltage gain	G _v	48	50	52	dB	V _{in} = -50 dBm
Voltage gain difference	G _v	—	—	+1.5	dB	V _{in} = -50 dBm
Output power	P _{out}	5.0	5.5	—	W	R _L = 4 Ω, V _{CC} = 13.2 V
		—	6.5	—		THD = 10 % V _{CC} = 14.4 V
Total harmonic distortion	THD	—	0.05	0.5	%	P _{out} = 1.5 W
Wide band noise	WBN	—	0.6	1.2	mV	R _g = 10 k Ω, BW = 20 Hz to 20 kHz
Supply voltage rejection ratio	SVR	35	50	—	dB	R _g = 600 Ω, f = 500 Hz
Input impedance	R _{in}	—	33	—	k	f = 1 kHz, V _{in} = -50 dBm
Roll off frequency	f _L	—	55	—	Hz	G _v = -3 dB Low
	f _H	—	50	—	kHz	from f = 1 kHz Ref High
Cross-talk	C.T	40	55	—	dB	R _g = 600 Ω, V _{in} = -50 dBm

2 channel operation

Item	Symbol	Min	Typ	Max	Unit	Test Conditions
Output power	Pout	—	5.3	—	W	THD = 10 %
Total harmonic distortion	THD	—	0.10	—	%	Pout = 1.5 W

Block Diagram

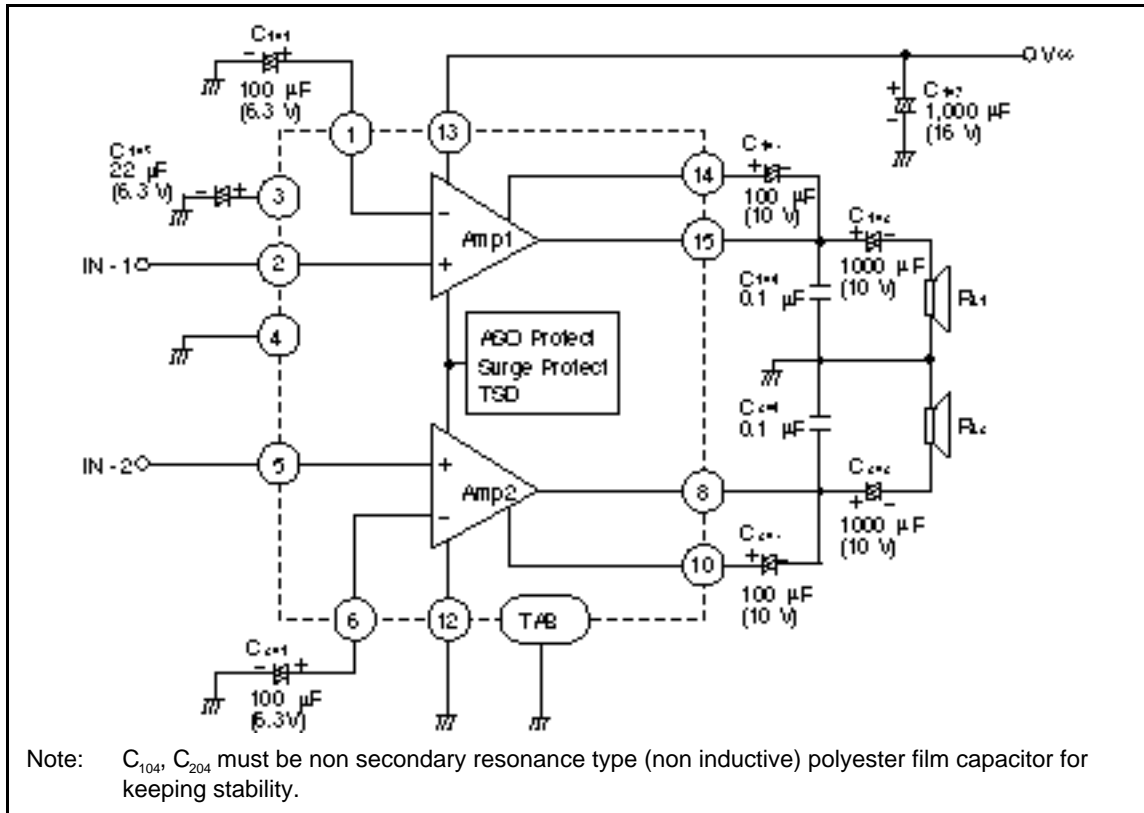

Figure 1 Typical Application Circuit

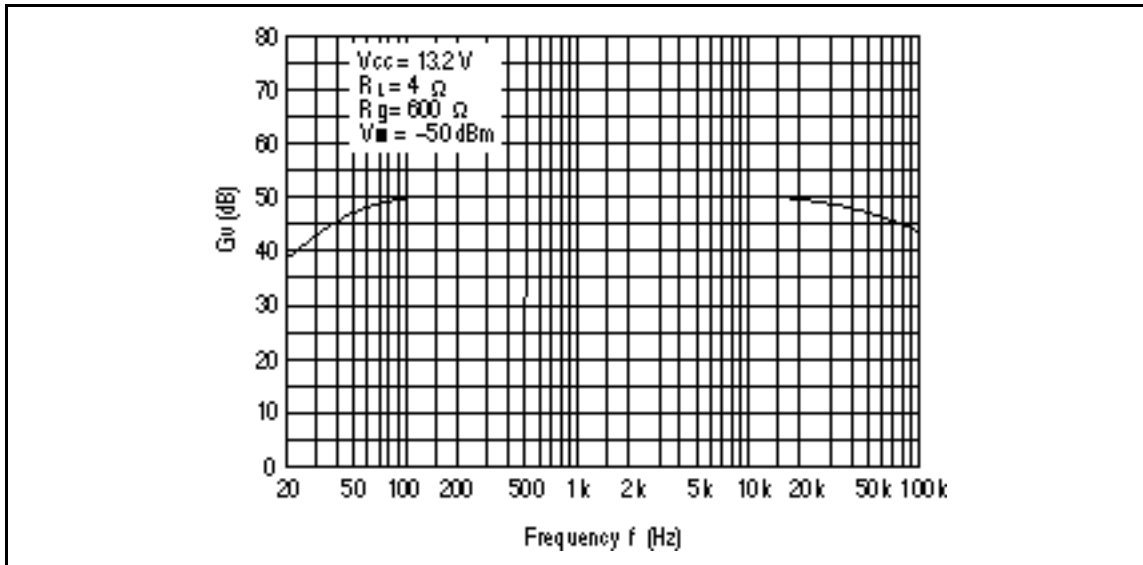

Figure 2 Voltage Gain vs. Frequency

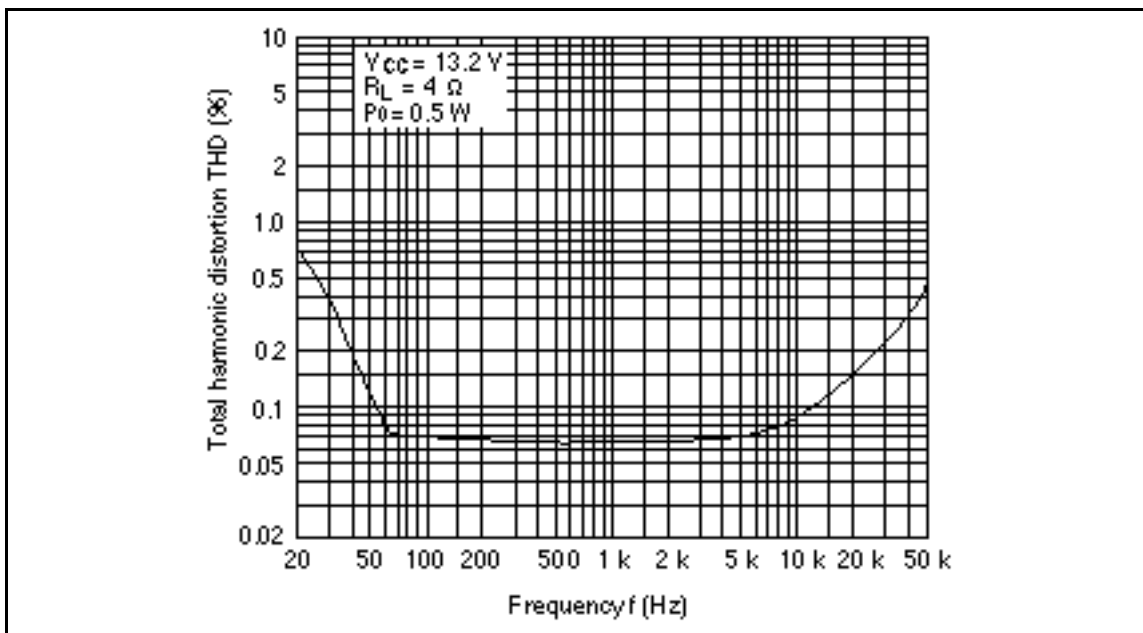

Figure 3 Total Harmonic Distortion vs. Frequency

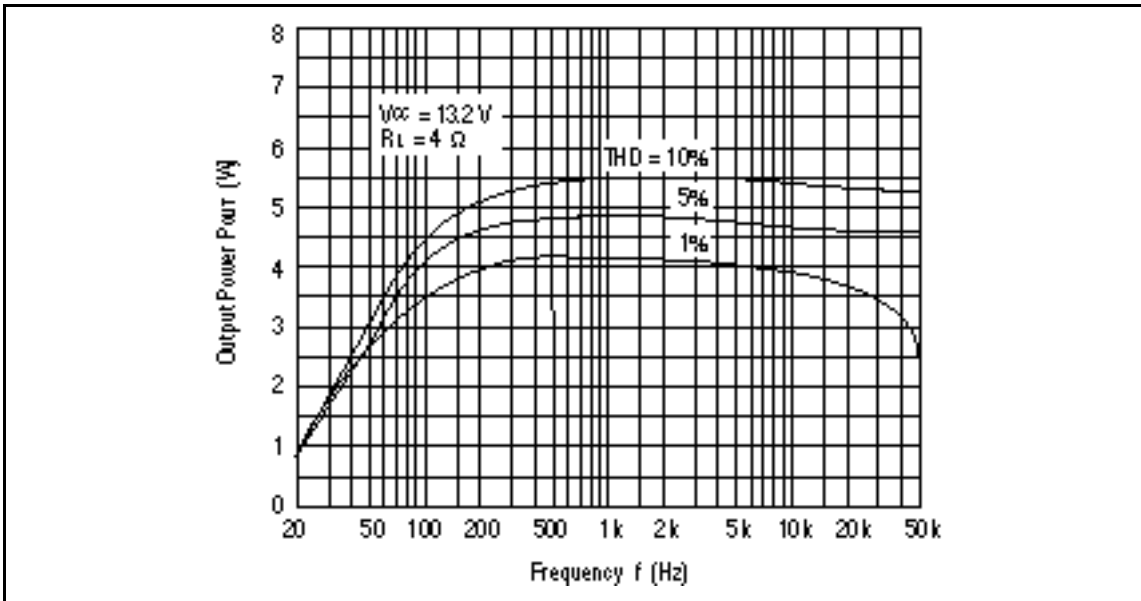

Figure 4 Output Power vs. Frequency

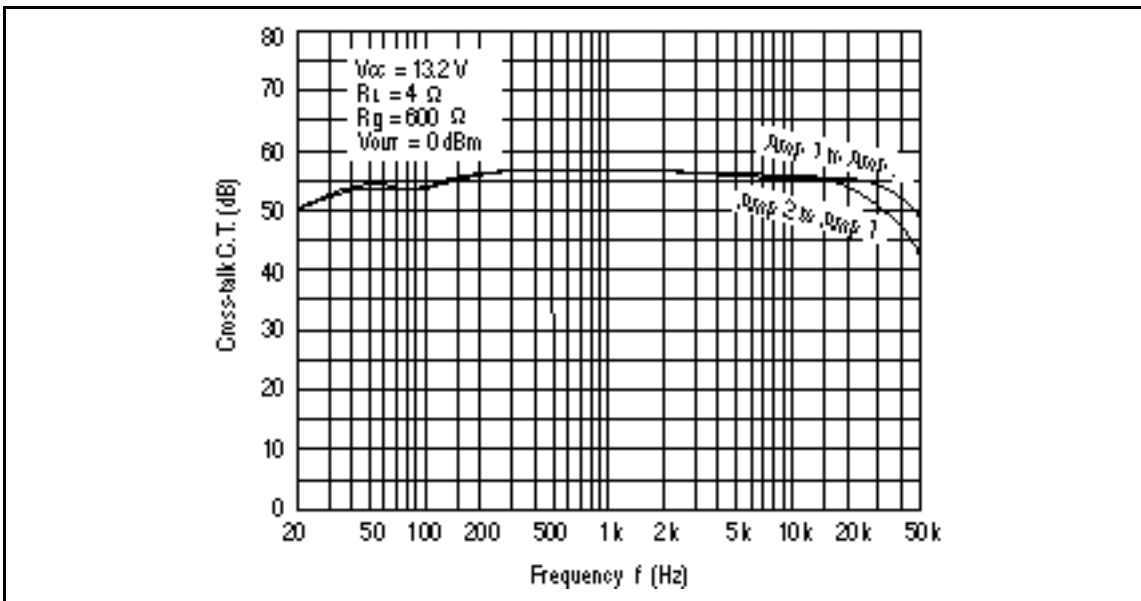

Figure 5 Cross-talk vs. Frequency

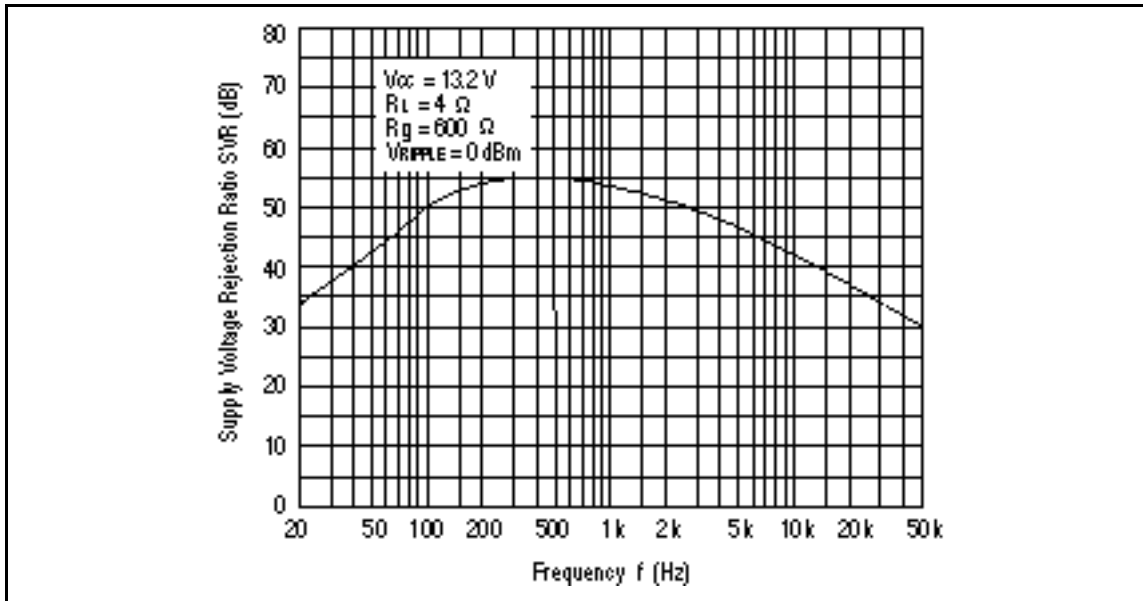

Figure 6 Supply Voltage Rejection Ratio vs. Frequency

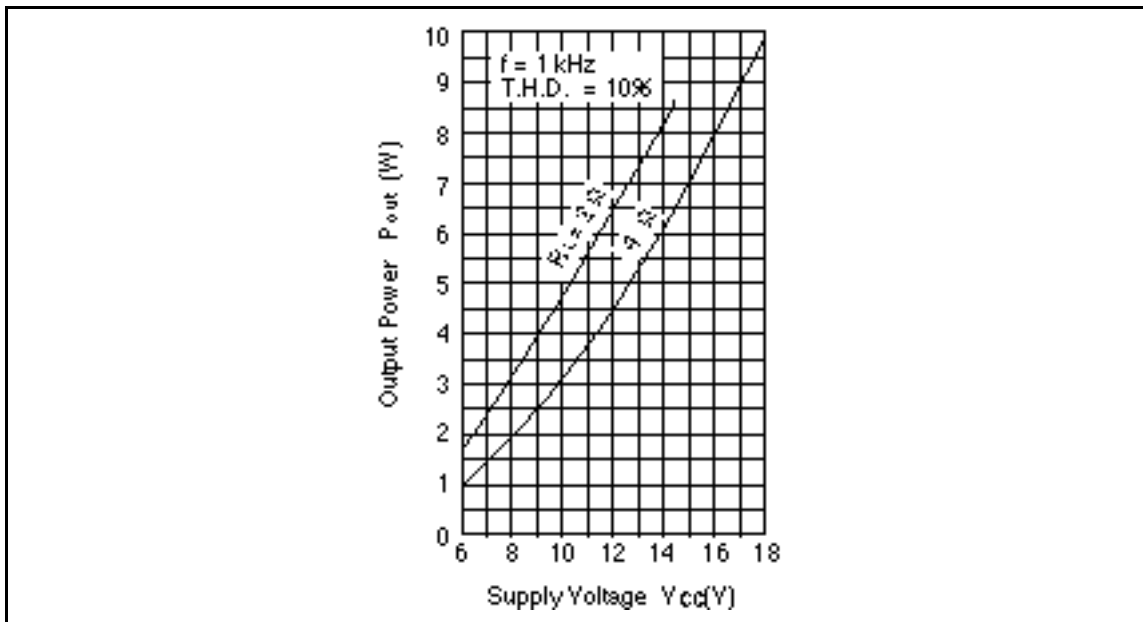

Figure 7 Output Power vs. Supply Voltage

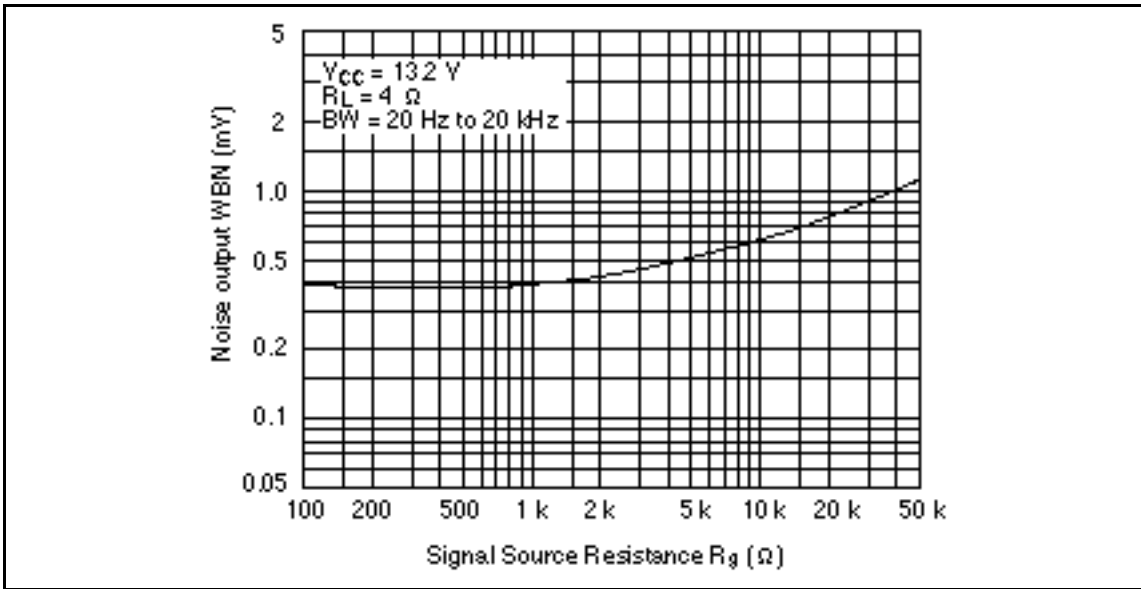

Figure 8 Noise Output vs. Signal Source Resistance

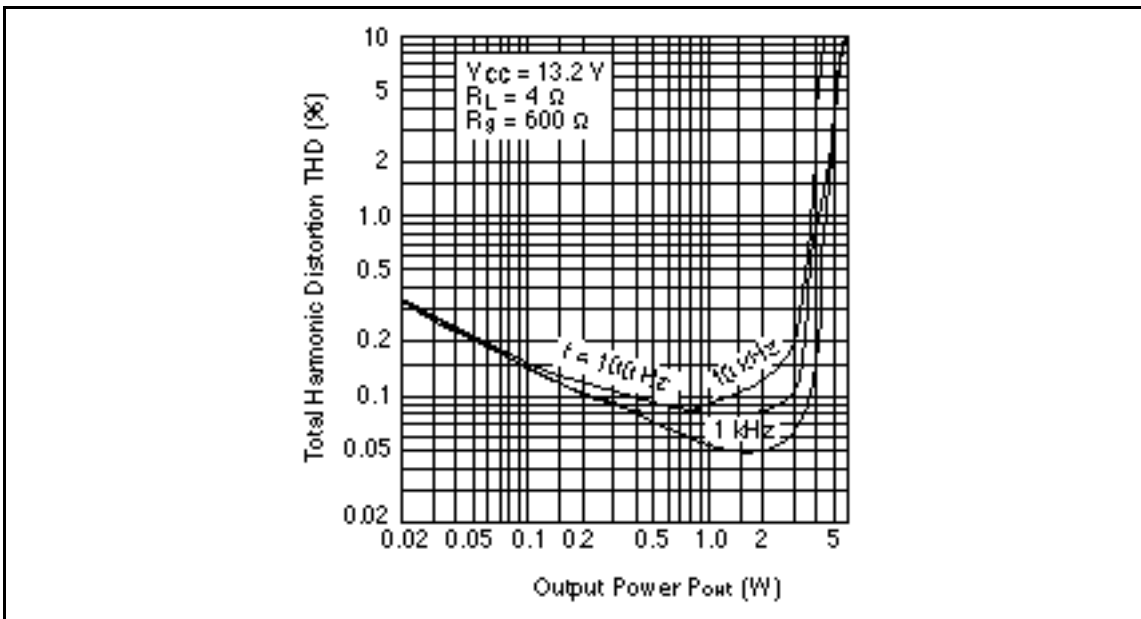

Figure 9 Total Harmonic Distortion vs. Output Power

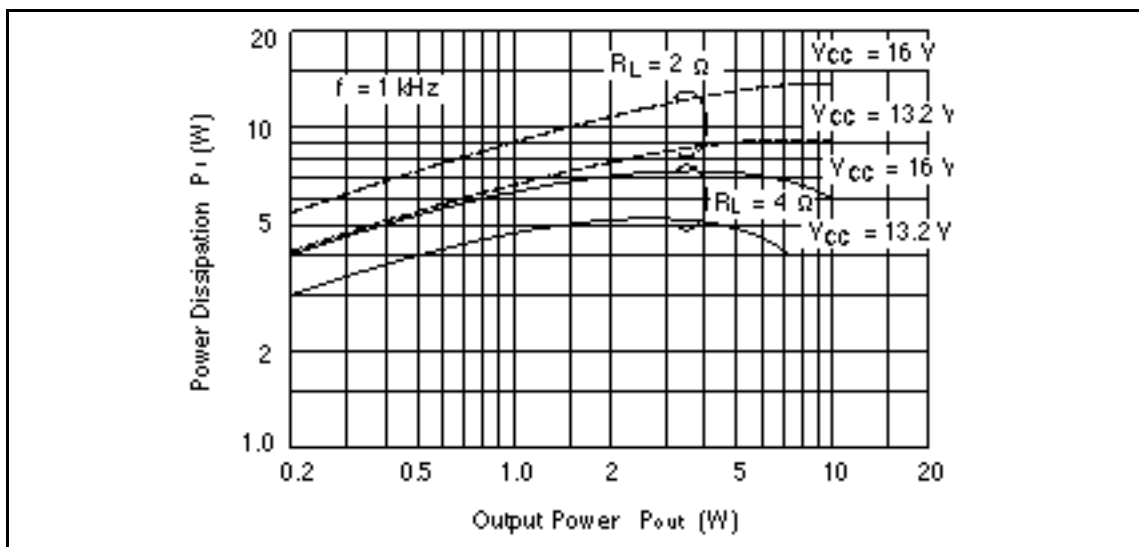

Figure 10 Power Dissipation vs. Output Power

When using this document, keep the following in mind:

1. This document may, wholly or partially, be subject to change without notice.
2. All rights are reserved: No one is permitted to reproduce or duplicate, in any form, the whole or part of this document without Hitachi's permission.
3. Hitachi will not be held responsible for any damage to the user that may result from accidents or any other reasons during operation of the user's unit according to this document.
4. Circuitry and other examples described herein are meant merely to indicate the characteristics and performance of Hitachi's semiconductor products. Hitachi assumes no responsibility for any intellectual property claims or other problems that may result from applications based on the examples described herein.
5. No license is granted by implication or otherwise under any patents or other rights of any third party or Hitachi, Ltd.
6. **MEDICAL APPLICATIONS:** Hitachi's products are not authorized for use in **MEDICAL APPLICATIONS** without the written consent of the appropriate officer of Hitachi's sales company. Such use includes, but is not limited to, use in life support systems. Buyers of Hitachi's products are requested to notify the relevant Hitachi sales offices when planning to use the products in **MEDICAL APPLICATIONS**.

HITACHI

Hitachi, Ltd.

Semiconductor & IC Div.

Nippon Bldg., 2-5-2, Ohite-machi, Chiyoda-ku, Tokyo 100, Japan

Tel Tokyo (03) 3270-2111

Fax (03) 3270-5109

For further information write to:

Hitachi America, Ltd.

Semiconductor & IC Div.

2000 Sierra Point Parkway

Brisbane, CA 94005-4835

U.S.A.

Tel 415-589-8300

Fax 415-589-4207

Hitachi Europe GmbH

Electronic Components Group

Continental Europe

Darnecker Straße 3

D-85622 Feldkirchen

München

Tel 089-9 91 80-0

Fax 089-9 29 30 00

Hitachi Europe Ltd.

Electronic Components Div.

Northern Europe Headquarters

Whitebrook Park

Lower Cookham Road

High Wycombe

Berkshire SL6 6YA

United Kingdom

Tel 0628-885000

Fax 0628-778322

Hitachi Asia Pte. Ltd.

45 Collyer Quay #20-00

Hitachi Tower

Singapore 0104

Tel 535-2100

Fax 535-1533

Hitachi Asia (Hong Kong) Ltd.

Unit 705, North Tower,

World Finance Centre

Harbour City, Canton Road

Tsim Sha Tsui, Kowloon

Hong Kong

Tel 27359218

Fax 27308074