

# HA12017

## Low Noise Preamplifier

### FEATURES

- Low Noise:  $V_n(\text{in})=0.185\mu\text{V}$  typ. (IHF-A Network,  $R_g=43\Omega$ , RIAA)
- Wide dynamic range:  $V_{in}=235\text{mVrms}$  typ. ( $V_{cc}=\pm 24.0\text{V}$ ,  $f=1\text{kHz}$ , THD=0.1%,  $G_v=35.9\text{dB}$ )
- Low distortion: THD=0.002% typ. ( $f=20\text{Hz}$  to  $20\text{kHz}$ ,  $V_{out}=10\text{Vrms}$ , RIAA)
- Excellent supply ripple rejection:
  - SVR(+ $V_{cc}$ )=56dB typ. ( $f=100\text{Hz}$ ,  $R_g=43\Omega$ )
  - SVR(- $V_{cc}$ )=45dB typ. ( $f=100\text{Hz}$ ,  $R_g=43\Omega$ )



(SP-7)

### BLOCK DIAGRAM & TYPICAL APPLICATION CIRCUIT

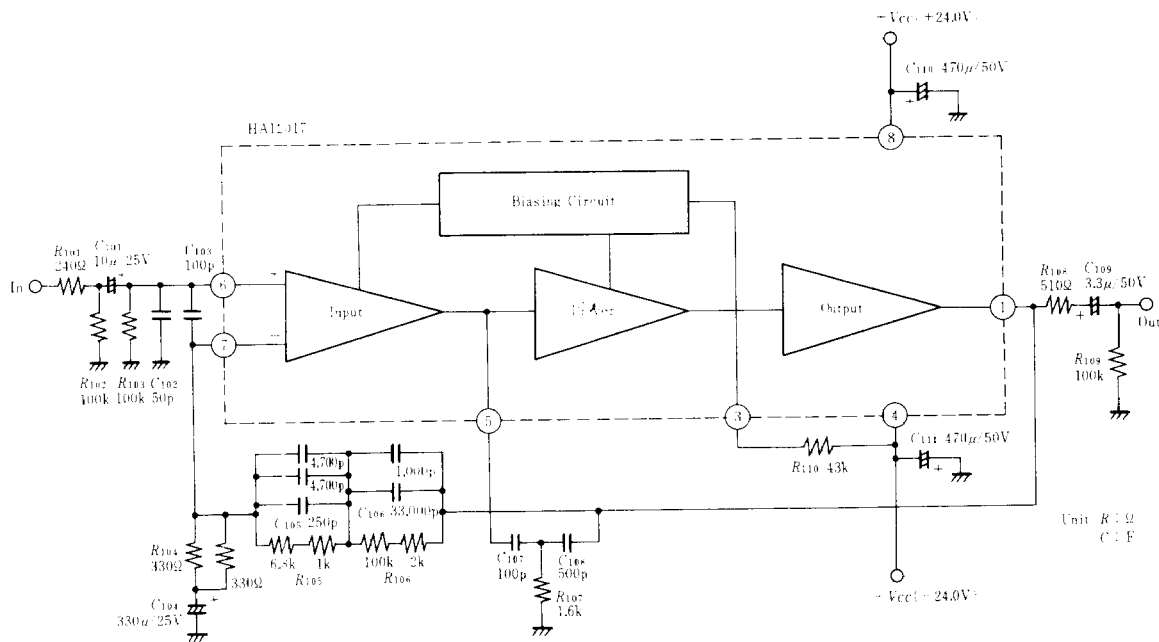

### ABSOLUTE MAXIMUM RATINGS

Item	Symbol	Rating	Unit
Supply Voltage	$V_{cc}$	$\pm 26.5$	V
Power Dissipation	$P_T^*$	500	mW
Operating Temperature Range	$T_{opr}$	-30 to +75	$^{\circ}\text{C}$
Storage Temperature Range	$T_{stg}$	-55 to +125	$^{\circ}\text{C}$

\* Value at  $T_a = 75^{\circ}\text{C}$

■ ELECTRICAL CHARACTERISTICS ( $V_{CC} = \pm 24V$ ,  $T_a = 25^\circ C$ )

Item*	Symbol	Test Conditions	min.	typ.	max.	Item
Quiescent Current	$I_Q$	no input signal	—	4.0	6.0	mA
Open Loop Voltage Gain	$G_{V(OL)}$	$f = 1kHz$	95	105	—	dB
Total Harmonic Distortion	THD	$f = 1kHz$ , $V_{out} = 10V$	—	0.002	0.01	%
Output Voltage	$V_{out}$	$f = 1kHz$ , THD = 0.1%	13.5	14.7	—	V
Output Noise Voltage 1**	$V_{n1}$	$R_g = 43\Omega$ , IHF-A Network	—	1.15	1.56	mV
Output Noise Voltage 2**	$V_{n2}$	$R_g = 3.3k\Omega$ , BW = 20Hz to 20kHz	—	5.3	9.0	mV

Notes : \* All the items except  $G_{V(OL)}$  is tested with RIAA curve and  $G_V = 35.9dB$ .

\*\*These items are measured after the flat amplifier ( $G_V = 40dB$ ).

■ TEST CIRCUIT

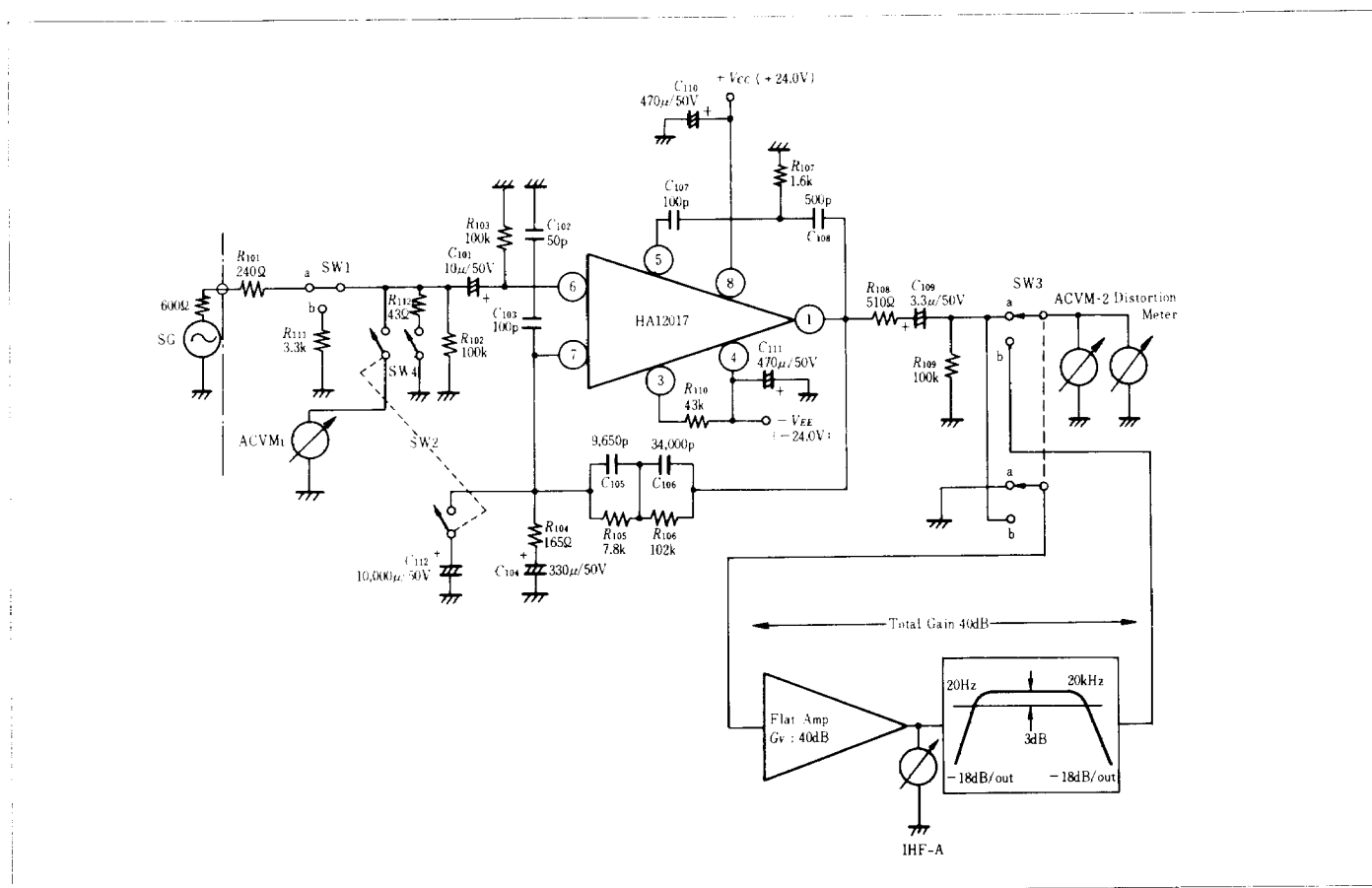

● NOTES "ON" TESTING

1. Measuring Apparatus

- SG: Matsushita VP7220B
- Distortion Meter: NF DM155
- IHF-A ACVM 3: B & K 2112
- ACVM 1 & 2: HP 400EL

2. Tolerance of External Parts

- Resistors:  $\pm 1\%$
- Mira Capacitor ( $C_{105}$ ,  $C_{106}$ ):  $\pm 2\%$
- Chemical Capacitor:  $\pm 10\%$
- Ceramic Capacitor ( $C_{102}$ ,  $C_{105}$ ,  $C_{107}$ ,  $C_{108}$ ):  $\pm 5\%$
- Temp. Coefficient  $-80ppm/^\circ C$

3. Positions of Switches

Item	SW 1	SW 2	SW 3	SW 4
$G_{V(OL)}$	a	ON	a	OFF
$V_{out}$	a	OFF	a	OFF
THD	a	OFF	a	OFF
$V_{n1}$	b	OFF	b	ON
$V_{n2}$	b	OFF	b	OFF

PC-BOARD LAYOUT PATTERN

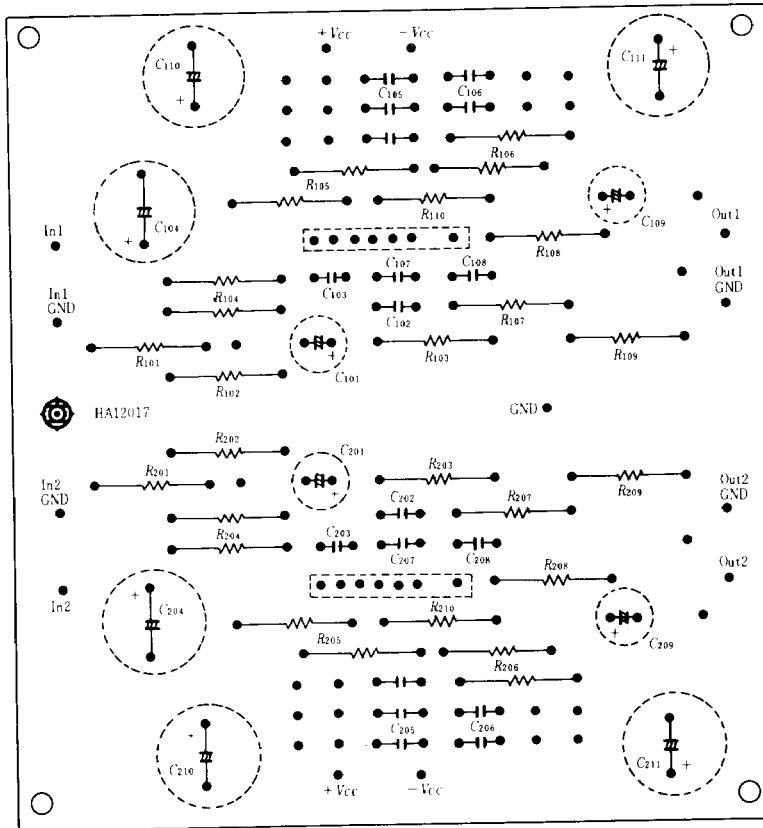

(Top View)

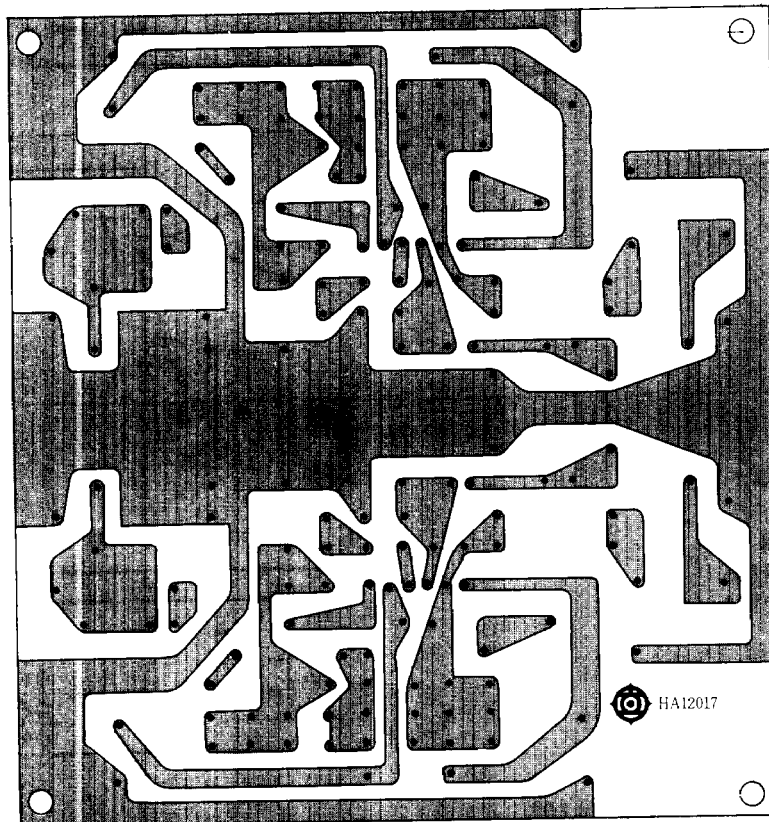

(Bottom View)

■ EXTERNAL COMPONENTS

1. Resistor

Part No.	Recommended Value	Functions	Deteriorations by using a value less than recommended	Deteriorations by using a value more than recommended	Cautions
R <sub>101</sub>	240Ω	<ul style="list-style-type: none"> <li>Protects the IC from abnormal input voltage.</li> <li>Prevents parastic oscillation caused by signal-source impedance.</li> <li>Decreases high-frequency disturbance.</li> </ul>	<ul style="list-style-type: none"> <li>High-frequency often disturbed.</li> <li>Using less than 43Ω deteriorates stability to a high degree.</li> </ul>	<ul style="list-style-type: none"> <li>Thermal noise generates, resulting in signal-to-noise ratio deterioration.</li> </ul>	
R <sub>102</sub>	100kΩ	<ul style="list-style-type: none"> <li>Passes the electric charge of C<sub>101</sub>.</li> <li>Decides R<sub>in</sub> (input resistance) <math>R_{in} = R_{101} + (R_{102}/R_{103})</math></li> </ul>	<ul style="list-style-type: none"> <li>Input resistance decreases.</li> </ul>	<ul style="list-style-type: none"> <li>Electric-charge passing lowered.</li> </ul>	
R <sub>103</sub>	100kΩ	<ul style="list-style-type: none"> <li>Supplies DC bias to pin-6 (input pin)</li> <li>Decides input resistance.</li> </ul>	<ul style="list-style-type: none"> <li>Input resistance decreases.</li> </ul>	<ul style="list-style-type: none"> <li>Output offset voltage increases.</li> </ul>	<ul style="list-style-type: none"> <li><math>R_{103} \cong R_{105} + R_{106}</math></li> </ul>
R <sub>104</sub>	165Ω	<ul style="list-style-type: none"> <li>Decides voltage gain as feedback resistance.</li> </ul>	<ul style="list-style-type: none"> <li>Load of pin-1 (output pin) increases in high-frequency range, reducing output voltage.</li> </ul>	<ul style="list-style-type: none"> <li>Thermal noise generates, resulting in signal-to-noise ratio deterioration.</li> </ul>	
R <sub>105</sub> R <sub>106</sub>	7.8kΩ 102kΩ	<ul style="list-style-type: none"> <li>Decides RIAA characteristics, in pairs with C<sub>105</sub> and C<sub>106</sub>.</li> </ul>	<ul style="list-style-type: none"> <li>Unbalance with R<sub>103</sub> increases output offset voltage.</li> </ul>	<ul style="list-style-type: none"> <li>Unbalance with C<sub>103</sub> increases output offset voltage.</li> </ul>	<ul style="list-style-type: none"> <li>The errors of R<sub>105</sub> and R<sub>106</sub> must be small enough.</li> </ul>
R <sub>107</sub>	1.6kΩ	<ul style="list-style-type: none"> <li>In a pair with C<sub>108</sub>, decides the frequency at which G<sub>V(OL)</sub> characteristic changes from -12dB/oct to -6dB/oct.</li> </ul>	<ul style="list-style-type: none"> <li>Incomplete phase-compensation deteriorates stability.</li> </ul>	<ul style="list-style-type: none"> <li>Total harmonic distortion increases.</li> </ul>	
R <sub>108</sub>	510Ω	<ul style="list-style-type: none"> <li>Prevents parastic oscillation caused by capacitive load.</li> </ul>	<ul style="list-style-type: none"> <li>Prevention of parastic oscillation lowered.</li> </ul>		
R <sub>109</sub>	100kΩ	<ul style="list-style-type: none"> <li>Keeps the voltage of output terminals at DC standard level.</li> <li>Prevents shock noise caused by function-switching.</li> </ul>	<ul style="list-style-type: none"> <li>Load increasing, max. output voltage decreases.</li> </ul>	<ul style="list-style-type: none"> <li>Prevention of shock noise lowered.</li> </ul>	
R <sub>110</sub>	43kΩ	<ul style="list-style-type: none"> <li>Decides basic bias current <math>R_{110} = (+V_{CC} - (-V_{CC}) - 5) \text{ k}\Omega</math></li> </ul>	<ul style="list-style-type: none"> <li>Excessive P<sub>7</sub> causes breakdown</li> <li>G<sub>V(OL)</sub> increasing, stability deteriorates.</li> <li>Noise caused by current increases.</li> </ul>	<ul style="list-style-type: none"> <li>G<sub>V(OL)</sub> decreasing, total harmonic distortion increases.</li> <li>Noise increases.</li> </ul>	<ul style="list-style-type: none"> <li>Capacitance must not connect-ed between R<sub>110</sub> and pin-4 /GND.</li> </ul>

2. Capacitor

Part No.	Recommended Value	Functions	Deteriorations by using a value less than recommended	Deteriorations by using a value more than recommended	Cautions
C <sub>101</sub>	10μF	<ul style="list-style-type: none"> <li>Makes input-coupling.</li> </ul>	<ul style="list-style-type: none"> <li>Impedance of signal source increasing, 1/f noise increases.</li> </ul>		<ul style="list-style-type: none"> <li>The leakage-current of C<sub>101</sub> must be small enough.</li> </ul>
C <sub>102</sub>	50pF	<ul style="list-style-type: none"> <li>In combination with C<sub>103</sub>, increases stability of large-amplitude operation in high frequency range.</li> </ul>	<ul style="list-style-type: none"> <li>Prevention of parastic oscillation lowered.</li> </ul>	<ul style="list-style-type: none"> <li>Input impedance decreases at high frequency range.</li> <li>Prevention of parastic oscillation lowered.</li> </ul>	<ul style="list-style-type: none"> <li>High-frequency characteristic of C<sub>102</sub> must be sufficient.</li> </ul>
C <sub>103</sub>	100pF	<ul style="list-style-type: none"> <li>In strong field, prevents detection of TV, FM and AM signals.</li> </ul>	<ul style="list-style-type: none"> <li>High-frequency often disturbed in a strong field.</li> <li>Prevention of parastic oscillation lowered.</li> </ul>	<ul style="list-style-type: none"> <li>Prevention of parastic oscillation lowered.</li> </ul>	<ul style="list-style-type: none"> <li>High-frequency characteristic of C<sub>103</sub> must be sufficient.</li> </ul>
C <sub>104</sub>	330μF	<ul style="list-style-type: none"> <li>Supplies full DC-feedback.</li> <li>Decides roll-off frequency (f<sub>L</sub>) in low frequency range. <math>f_L = 3\text{Hz}</math> (Typical application) <math>f_L = \frac{1}{2\pi C_{104} \cdot R_{104}}</math></li> </ul>	<ul style="list-style-type: none"> <li>Roll-off frequency in low-frequency range goes higher.</li> </ul>	<ul style="list-style-type: none"> <li>More time is required to stabilize the potential of pin-1.</li> </ul>	
C <sub>105</sub> C <sub>106</sub>	9650pF 34000pF	<ul style="list-style-type: none"> <li>Decides RIAA characteristics in pairs with R<sub>105</sub> and R<sub>106</sub>.</li> </ul>	<ul style="list-style-type: none"> <li>RIAA characteristics deteriorates.</li> </ul>	<ul style="list-style-type: none"> <li>RIAA characteristics deteriorates.</li> </ul>	<ul style="list-style-type: none"> <li>The errors of C<sub>105</sub> and C<sub>106</sub> must be small enough.</li> </ul>
C <sub>107</sub>	100pF	<ul style="list-style-type: none"> <li>Supplies phase-compensation.</li> </ul>	<ul style="list-style-type: none"> <li>Incomplete phase-compensation deteriorates stability.</li> </ul>	<ul style="list-style-type: none"> <li>Total harmonic distortion increases.</li> </ul>	<ul style="list-style-type: none"> <li>For C<sub>107</sub>, temperature and high-frequency characteristics must be sufficient, and the error must be small enough.</li> </ul>
C <sub>108</sub>	500pF	<ul style="list-style-type: none"> <li>In a pair with R<sub>107</sub>, decides the frequency at which G<sub>V(OL)</sub> characteristic changes from -12dB/oct to -6dB/oct.</li> </ul>	<ul style="list-style-type: none"> <li>Incomplete phase-compensation deteriorates stability.</li> </ul>	<ul style="list-style-type: none"> <li>Total harmonic distortion increases.</li> </ul>	<ul style="list-style-type: none"> <li>For C<sub>108</sub>, temperature and high-frequency characteristics must be sufficient, and the error must be small enough.</li> </ul>
C <sub>109</sub>	3.3μF	<ul style="list-style-type: none"> <li>Makes output-coupling.</li> </ul>	<ul style="list-style-type: none"> <li>Too low capacitance increases output-impedance and reduces output voltage in low frequency range.</li> </ul>		
C <sub>110</sub> C <sub>111</sub>	470μF 470μF	<ul style="list-style-type: none"> <li>Removes ripple on V<sub>CC</sub> line.</li> </ul>	<ul style="list-style-type: none"> <li>Increases cross-talk between left and right channels.</li> </ul>		

**INPUT NOISE VOLTAGE  
vs. SOURCE IMPEDANCE**

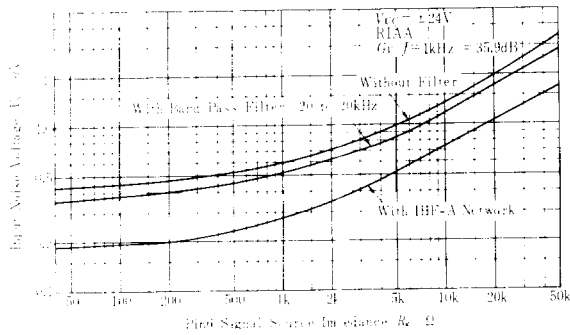

**TOTAL HARMONIC DISTORTION  
vs. OUTPUT VOLTAGE**

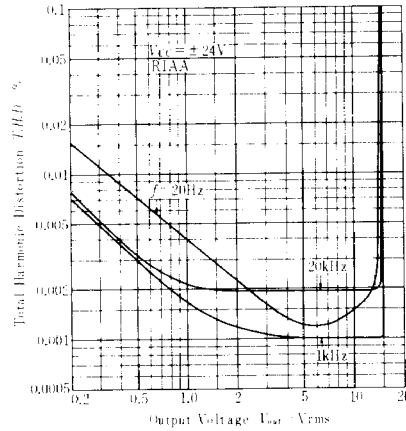

**OUTPUT VOLTAGE  
vs. INPUT VOLTAGE**

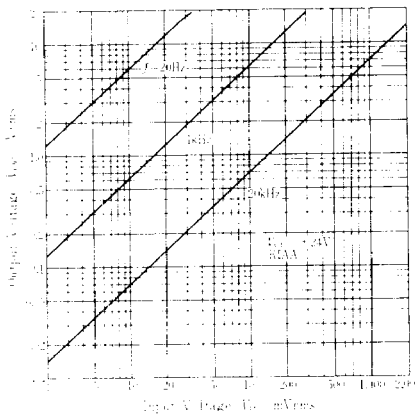

**OPEN-LOOP VOLTAGE GAIN  
vs. FREQUENCY**

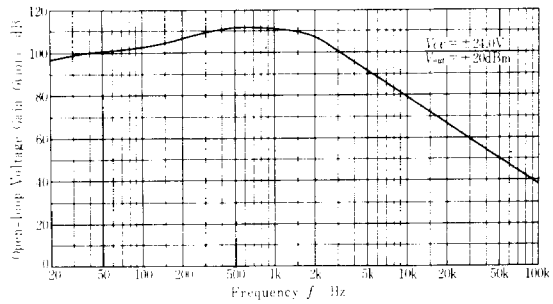

**CLOSED-LOOP VOLTAGE GAIN  
vs. FREQUENCY**

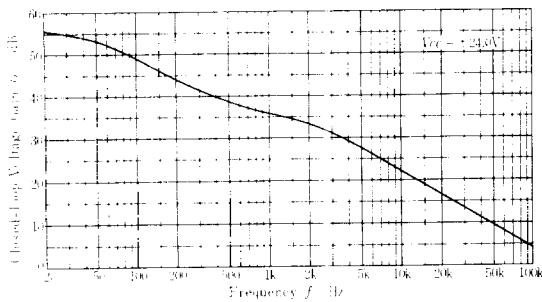

**OUTPUT VOLTAGE AND TOTAL HARMONIC DISTORTION vs. FREQUENCY**

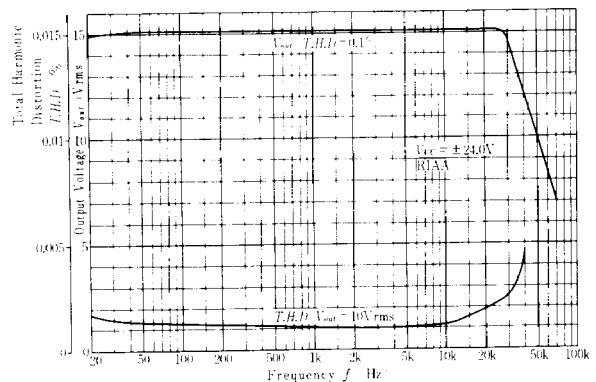

**RIPPLE REJECTION VS. FREQUENCY**

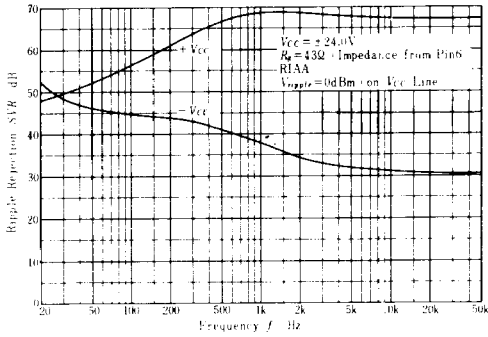

**RIPPLE REJECTION VS. SOURCE IMPEDANCE**

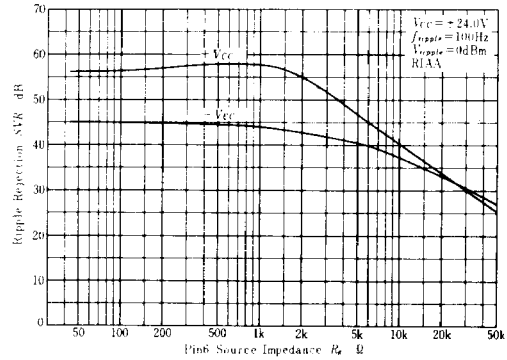

**QUIESCENT CURRENT VS. SUPPLY VOLTAGE**

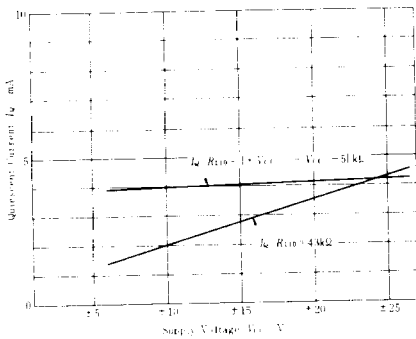

**OUTPUT VOLTAGE VS. SUPPLY VOLTAGE**

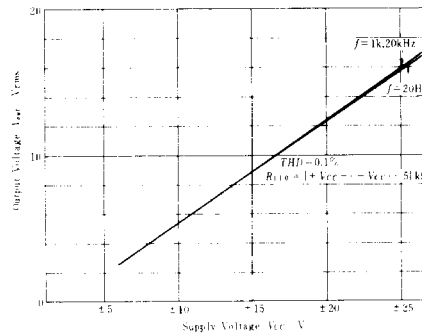

**INPUT NOISE VOLTAGE VS. SUPPLY VOLTAGE**

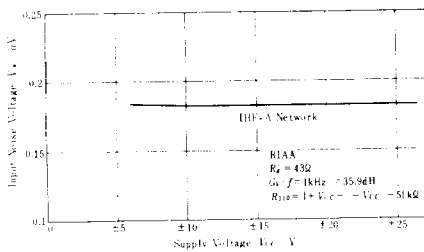

**OUTPUT VOLTAGE AND TOTAL HARMONIC DISTORTION VS. AMBIENT TEMPERATURE**

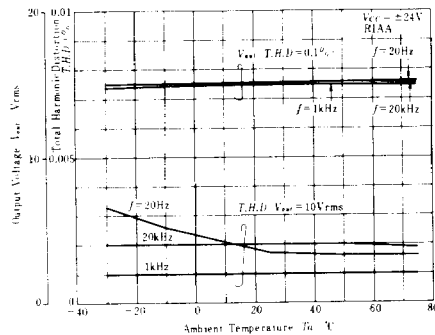

**QUIESCENT CURRENT VS. AMBIENT TEMPERATURE**

