

HA11235

Synchronous Signal Processing System

Functions

- Sync separator
- Horizontal automatic frequency control (AFC)
- Horizontal oscillator
- X-ray protector
- Vertical oscillator
- Vertical driver

Features

- Fewer external components
- 10 V_{p-p} sync separator output
- Voltage regulator for horizontal supply voltage
- 7.5 Hz/rad horizontal AFC DC loop gain
- Output stage positive feedback eliminated by vertical oscillator's astable multivibrator
- Vertical oscillator waveform used for vertical output drive; only one high-stability (tantalum) capacitor required for vertical stage
- Vertical output stage stabilized by DC feedback to pin 3
- Vertical linearity adjustment can be eliminated

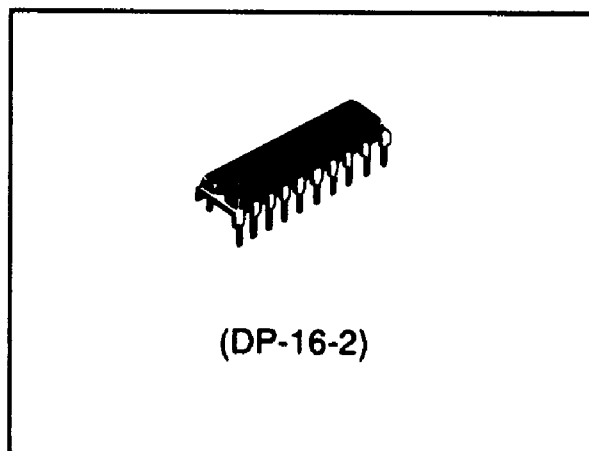

Ordering Information

Type No.	Package
HA11235	DP-16-2

Pin Description

Pin No.	Function	Max. Input/Output Voltage/Current
1	Connected to capacitor to prevent parasitic oscillation	Less than V _{CC}
2	Vertical output pin	15 mA
3	Feedback input pin for vertical DC/AC output voltage	Less than V _{CC}
4	Connected to resistor to determine vertical oscillation discharge time constant	5 mA
5	Connected to capacitor for vertical oscillation frequency	Less than V _{CC}
6	Vertical oscillator power supply pin	16 V
7	Vertical sync input pin	Less than V _{CC}
8	Determines vertical oscillation frequency	5 mA
9	X-ray protector input pin	5 mA
10	Horizontal section output pin	15 mA
11	Horizontal oscillator power supply pin	25 mA
12	Connected to horizontal oscillator CR	12 V



Pin Description (cont)

Pin No.	Function	Max. Input/Output Voltage/Current
13	Phase detector FBP (flyback pulse) input pin	5 V _{p-p}
14	Phase detector output pin	2 mA
15	Sync separator video signal input pin	3 mA
16	Sync separator output pin	15 mA
17	Sync separator feedback pin	12 V
18	GND pin	—

Block Diagram

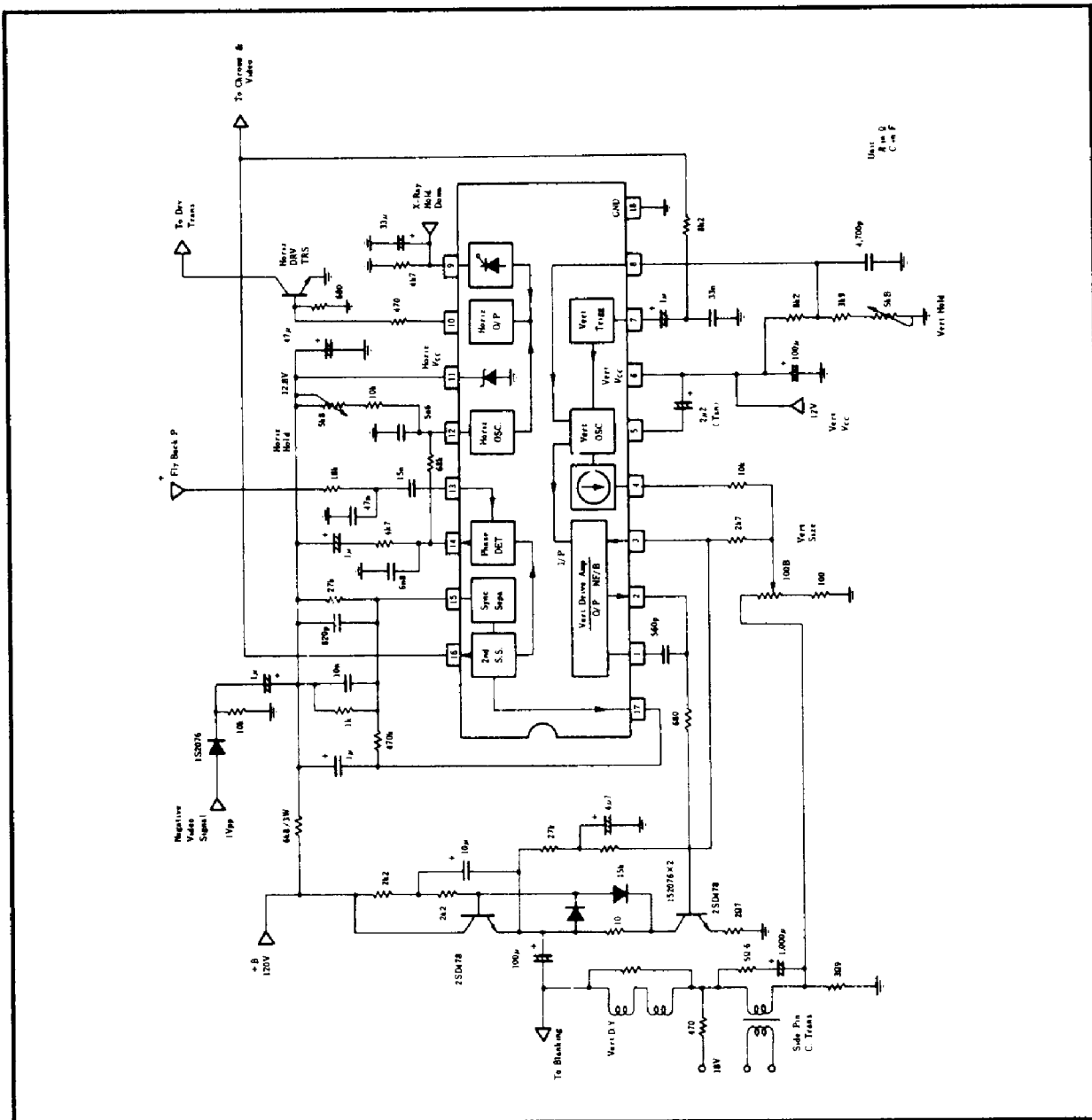

Circuit Schematics

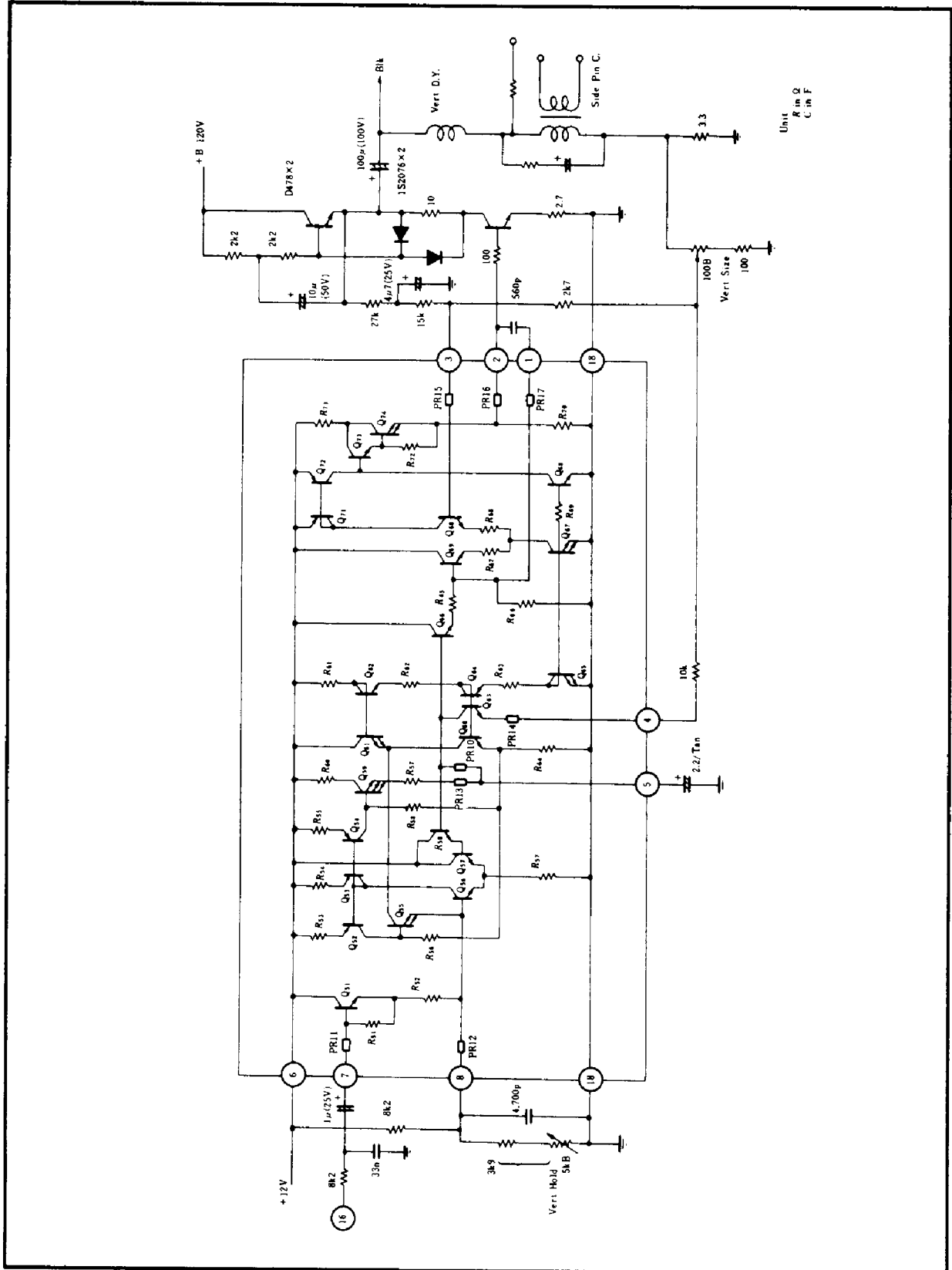

Figure 1 Vertical Oscillator and Driver



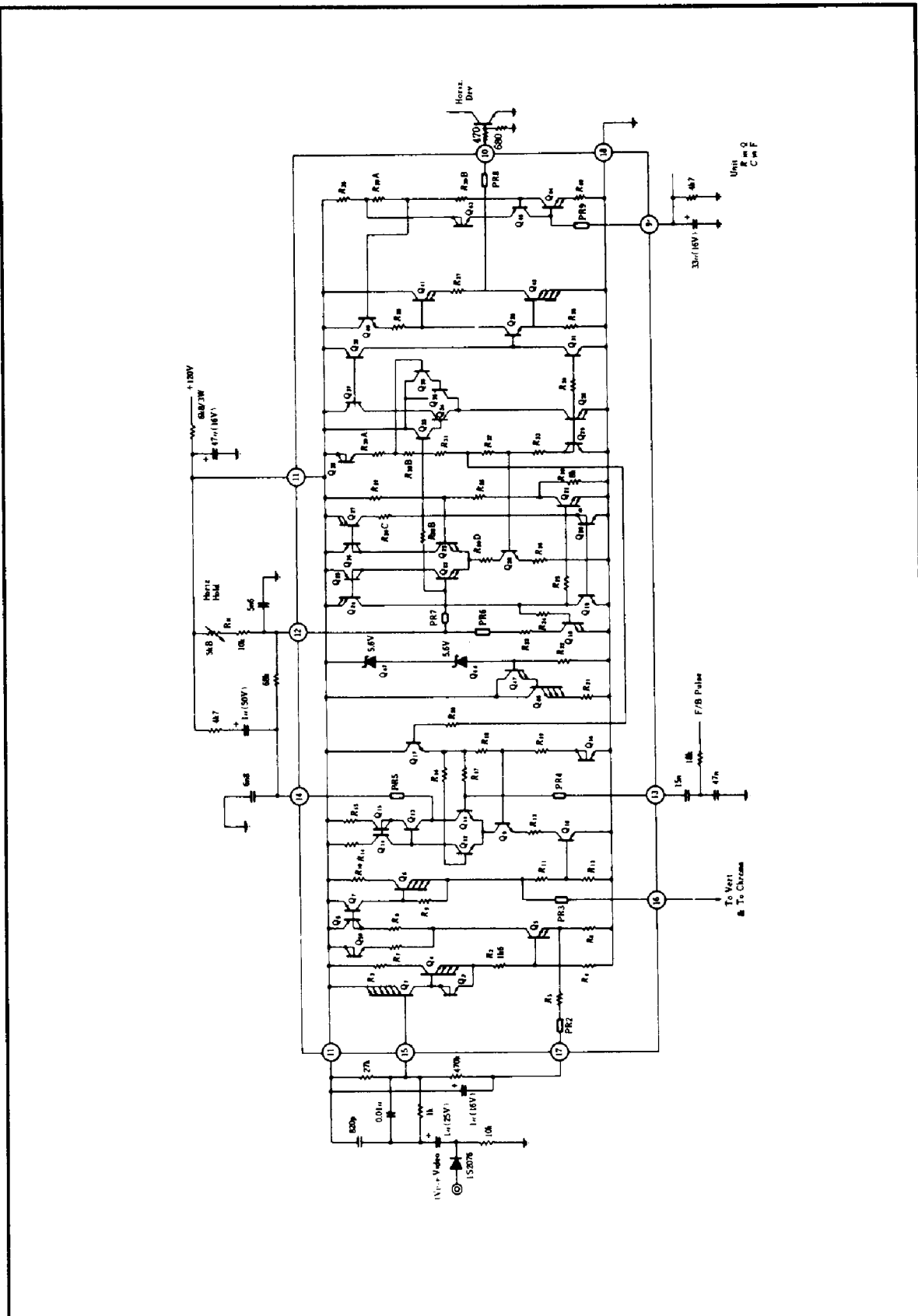

Figure 2 Circuit Schematic (Sync Separator and Horizontal APC)



Hitachi America, Ltd. • Hitachi Plaza • 2000 Sierra Point Pkwy. • Brisbane, CA 94005-1819 • (415) 589-8300

External Parts Functions

Pin No.	Part No.	Functions	
1, 2, 3	C ₁₀₉	<ul style="list-style-type: none"> • Feedback capacitor preventing parasitic oscillation • Determines closed loop gain (560 pF recommended to prevent abnormal oscillation and crossover distortion) 	
	R ₁₁₁	<ul style="list-style-type: none"> • Current limiter • Prevents excessive current and surge breakdown • Determines Q₂₀₂ base current value 	
	R ₁₁₀	<ul style="list-style-type: none"> • Determines vertical oscillation section's idling current 	
	R ₁₀₆	<ul style="list-style-type: none"> • Determines DC feedback to pin 3 <p>where $V_{1\ DC} = \text{DC voltage at pin 1 (3.3 V type)}$ $V_{+B} = +B \text{ supply voltage applied to the vertical}$</p> $\frac{V_{1\ DC}}{R_{112}} \times (R_{112} + R_{109} + R_{108}) = \frac{V_{+B}}{2}$ $I_{dy} = \frac{V_{p-p}(R_{112} + R_{109})}{R_{109} R_{117}}$ <p>output I_{dy} = current into the deflection yoke V_{p-p} = peak-to-peak voltage at pin 1 (1.5 V_{p-p})</p>	
	R ₁₁₇	<ul style="list-style-type: none"> • Determines deflection current 	
	C ₁₀₆	<ul style="list-style-type: none"> • Decoupling capacitor 	
	C ₁₀₅	<ul style="list-style-type: none"> • Bootstrap capacitor 	
	R ₁₁₅	<ul style="list-style-type: none"> • Determines vertical size 	
	4	R ₁₀₅	<ul style="list-style-type: none"> • Determines vertical oscillator's discharging time • Vertical deflection yoke current linearity adjustment (Large R₁₀₅ value lengthens discharging time and reduces oscillation frequency)
		C ₁₀₄	<ul style="list-style-type: none"> • Determines vertical oscillation discharging time constant (Tantalum capacitor recommended)
7	R ₁₀₁ , C ₁₀₁	<ul style="list-style-type: none"> • Integrates composite vertical sync pulse • Determines vertical pull-in range 	
	C ₁₀₂	<ul style="list-style-type: none"> • AC coupling capacitor 	
8	R ₁₀₂ , R ₁₀₃ , R ₁₀₄	<ul style="list-style-type: none"> • Determines vertical oscillation bottom voltage (Lower bias voltage at pin 8 increases peak-to-peak oscillation level and reduces oscillation frequency) 	
	C ₁₀₃	<ul style="list-style-type: none"> • Integrates composite vertical sync pulse • Eliminates horizontal sync component 	
9	R ₁₃₂ , C ₁₃₀	<ul style="list-style-type: none"> • Highpass filter in X-ray protection circuit 	
10	R ₁₃₀	<ul style="list-style-type: none"> • Protects against surge breakdown 	
	R ₁₃₁	<ul style="list-style-type: none"> • Determines horizontal drive transistor on/off level 	



HA11235

External Parts Functions (cont)

Pin No.	Part No.	Functions
11	R ₁₂₉	• Determines +B supply current into horizontal drive transistor (Supply 15 mA current. Approximately 9 mA consumed internally and 6 mA used to keep V _{CC} level constant.)
	C ₁₂₉	• Decoupling capacitor for constant V _{CC}
12	C ₁₂₈ , R ₁₂₆ , R ₁₂₇	• Horizontal oscillation (Larger time constant reduces oscillation frequency)
14	R ₁₂₅ , R ₁₂₈ , C ₁₂₇	• Determine AFC circuit AC loop gain
	C ₁₂₆	• Bypass capacitor
15, 17	C ₁₂₀	• Eliminates high frequency noise
	C ₁₂₁ , R ₁₂₀ , R ₁₂₁ , R ₁₂₂ , C ₁₂₂ , C ₁₂₃	• Determines sync separator base time constant R ₁₂₀ : Discharging R ₁₂₂ : Negative feedback C ₁₂₂ : Pin 17 time constant credit C ₁₂₃ : Separates stable sync
	D ₁₀₃	• Noise limiter

- Notes
1. Use the service switch to turn the vertical output off, with pin 3 grounded.
 2. C₁₂₈ (horizontal oscillator): Use polyester capacitors and polypropylene capacitors in 1:1 ratio for zero of the temperature coefficient of the horizontal oscillation frequency.

Notes for Pattern Wiring

1. To avoid problems like frequency offset, the GND pin should be connected to the GND line in the video detection section.
2. The GND lines in the external application circuit's horizontal and vertical sections should be kept separate until connected at the same point.
3. Problems like offset in the horizontal oscillator section have been caused by separation and long wiring of pin 12 and 14 V_{CC} lines.
4. 470 Ω and 680 Ω resistances at pin 10 should be connected close to the GND.



Absolute Maximum Ratings ($T_a = 25^\circ\text{C}$ unless otherwise specified)

Item	Symbol	Rating	Unit
Supply Voltage	V_{CC}	16	V
Operating Temperature Range	T_{opr}	-20 to +75	$^\circ\text{C}$
Storage Temperature Range	T_{stg}	-55 to +125	$^\circ\text{C}$
Power Dissipation ($T_a = 75^\circ\text{C}$)	P_T	500	mW
Output Current (Pin 2, 10, and 16)	I_O	20	mA

Electrical Characteristics**Table 1 Line Circuitry**

Item	Symbol	Min	Typ	Max	Unit	Test Conditions
Regulated Voltage	V_{11}	—	12.8	—	V	$I_{CC} = 15 \text{ mA}$
Supply Current	I_{CC}	—	15	—	mA	
Free-Running Frequency	f_{oh}	14,734	15,734	16,734	Hz	$R_h = 12.6 \text{ k}\Omega$, $C_h = 5.6 \text{ nF}$
Pull-In Range	Δf_{ph}	± 450	± 650	—	Hz	
APC Loop Gain	f_c	577.5	750	1070	Hz/ μs	
Temperature Coefficient	Δf_{oh}	-6.0	-3.0	0	Hz/ $^\circ\text{C}$	
Output Pulse Width	t_{hw}	22.5	25.0	27.5	μs	Pin 10

Table 2 Frame Circuitry

Item	Symbol	Min	Typ	Max	Unit	Test Conditions
Free-Running Frequency	f_{ov}	55	60	65	Hz	$R_v = 5.2 \text{ k}\Omega$
Pull-In Range	Δf_{pv}	—	-10	-7.5	Hz	
Temperature Coefficient	Δf_{ov}	-0.03	0	+0.03	Hz/ $^\circ\text{C}$	

Table 3 Sync Separator

Item	Symbol	Min	Typ	Max	Unit	Test Conditions
Input Voltage Peak-to-Peak Value	V_{15}	0.2	—	—	V	Negative-going sync
Output Voltage	V_{sy}	8.0	10.0	—	V	Peak-to-peak value
Output Pulse Width	t_{sy}	4.5	5.0	5.5	μs	Pin 16



Typical Performance Curves

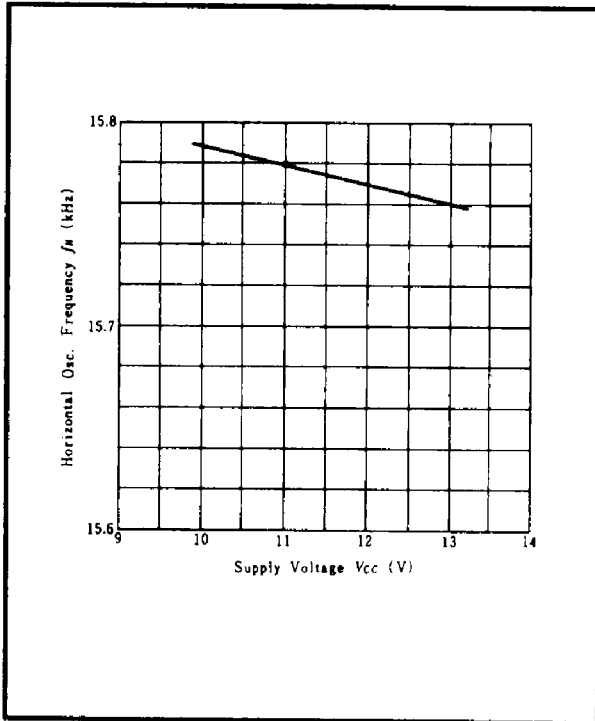

Figure 4 Horizontal Oscillation Frequency vs. Supply Voltage

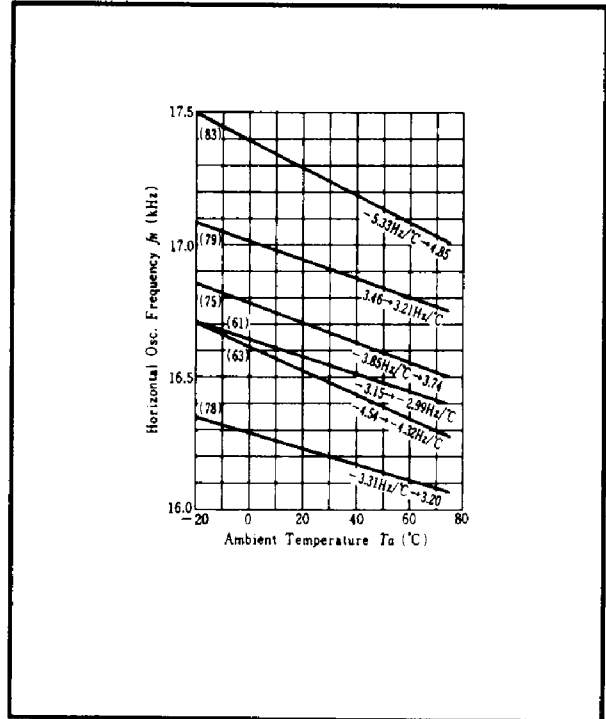

Figure 5 Horizontal Frequency vs. Ambient Temperature

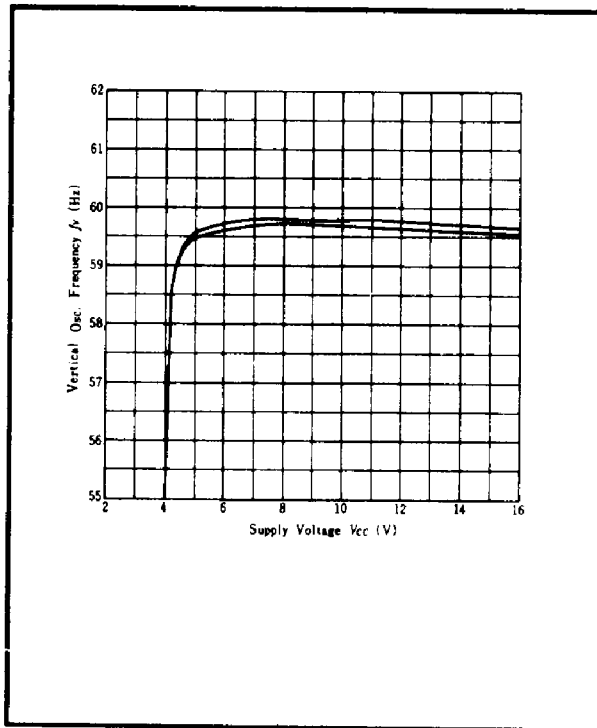

Figure 6 Vertical Oscillation Frequency vs. Supply Voltage

