

## 54121/DM54121/DM74121 One-Shot with Clear and Complementary Outputs

### General Description

The DM54/74121 is a monostable multivibrator featuring both positive and negative edge triggering with complementary outputs. An internal  $2k\Omega$  timing resistor is provided for design convenience minimizing component count and layout problems. This device can be used with a single external capacitor. Inputs (A) are active-low trigger transition inputs and input (B) is an active-high transition Schmitt-trigger input that allows jitter-free triggering from inputs with transition rates as slow as 1 volt/second. A high immunity to  $V_{CC}$  noise of typically 1.5V is also provided by internal circuitry at the input stage.

To obtain optimum and trouble free operation please read operating rules and NSC one-shot application notes carefully and observe recommendations.

### Features

- Triggered from active-high transition or active-low transition inputs
- Variable pulse width from 30 ns to 28 seconds

- Jitter free Schmitt-trigger input
- Excellent noise immunity typically 1.2V
- Stable pulse width up to 90% duty cycle
- TTL, DTL compatible
- Compensated for  $V_{CC}$  and temperature variations
- Input clamp diodes
- Alternate Military/Aerospace device (54121) is available. Contact a National Semiconductor Sales Office/Distributor for specifications.

### Functional Description





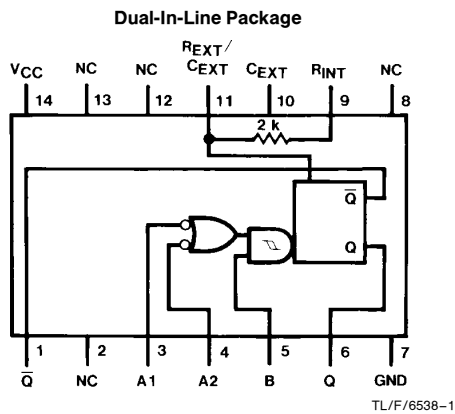





The basic output pulse width is determined by selection of an internal resistor  $R_{INT}$  or an external resistor ( $R_X$ ) and capacitor ( $C_X$ ). Once triggered the output pulse width is independent of further transitions of the inputs and is a function of the timing components. Pulse width can vary from a few nano-seconds to 28 seconds by choosing appropriate  $R_X$  and  $C_X$  combinations. There are three trigger inputs from the device, two negative edge-triggering (A) inputs, one positive edge Schmitt-triggering (B) input.



### Connection Diagram



Order Number 54121DMQB, 54121FMQB,  
DM54121J, DM54121W or DM74121N  
See NS Package Number J14A, N14A or W14B

### Function Table

Inputs			Outputs	
A1	A2	B	Q	$\bar{Q}$
L	X	H	L	H
X	L	H	L	H
X	X	L	L	H
H	H	X	L	H
H	H	H		
↓	H	H		
↓	↓	H		
L	X	↑		
X	L	↑		

- H = High Logic Level
- L = Low Logic Level
- X = Can Be Either Low or High
- ↑ = Positive Going Transition
- ↓ = Negative Going Transition
-  = A Positive Pulse
-  = A Negative Pulse

## Absolute Maximum Ratings (Note)

If Military/Aerospace specified devices are required, please contact the National Semiconductor Sales Office/Distributors for availability and specifications.

Supply Voltage	7V
Input Voltage	5.5V
Operating Free Air Temperature Range	
DM54	-55°C to +125°C
DM74	0°C to +70°C
Storage Temperature Range	-65°C to +150°C

Note: The "Absolute Maximum Ratings" are those values beyond which the safety of the device cannot be guaranteed. The device should not be operated at these limits. The parametric values defined in the "Electrical Characteristics" table are not guaranteed at the absolute maximum ratings. The "Recommended Operating Conditions" table will define the conditions for actual device operation.

## Recommended Operating Conditions

Symbol	Parameter	DM54121			DM74121			Units
		Min	Nom	Max	Min	Nom	Max	
V <sub>CC</sub>	Supply Voltage	4.5	5	5.5	4.75	5	5.25	V
V <sub>T+</sub>	Positive-Going Input Threshold Voltage at the A Input (V <sub>CC</sub> = Min)		1.4	2		1.4	2	V
V <sub>T-</sub>	Negative-Going Input Threshold Voltage at the A Input (V <sub>CC</sub> = Min)	0.8	1.4		0.8	1.4		V
V <sub>T+</sub>	Positive-Going Input Threshold Voltage at the B Input (V <sub>CC</sub> = Min)		1.5	2		1.5	2	V
V <sub>T-</sub>	Negative-Going Input Threshold Voltage at the B Input (V <sub>CC</sub> = Min)	0.8	1.3		0.8	1.3		V
I <sub>OH</sub>	High Level Output Current			-0.4			-0.4	mA
I <sub>OL</sub>	Low Level Output Current			16			16	mA
t <sub>w</sub>	Input Pulse Width (Note 1)	40			40			ns
dV/dt	Rate of Rise or Fall of Schmidt Input (B) (Note 1)			1			1	V/s
dV/dt	Rate of Rise or Fall of Logic Input (A) (Note 1)			1			1	V/μs
R <sub>EXT</sub>	External Timing Resistor (Note 1)	1.4		30	1.4		40	kΩ
C <sub>EXT</sub>	External Timing Capacitance (Note 1)	0		1000	0		1000	μF
DC	Duty Cycle (Note 1)	R <sub>T</sub> = 2 kΩ		67			67	%
		R <sub>T</sub> = R <sub>EXT</sub> (Max)		90			90	
T <sub>A</sub>	Free Air Operating Temperature	-55		125	0		70	°C

Note 1: T<sub>A</sub> = 25°C and V<sub>CC</sub> = 5V.

## Electrical Characteristics over recommended operating free air temperature range (unless otherwise noted)

Symbol	Parameter	Conditions	Min	Typ (Note 1)	Max	Units
V <sub>I</sub>	Input Clamp Voltage	V <sub>CC</sub> = Min, I <sub>I</sub> = -12 mA			-1.5	V
V <sub>OH</sub>	High Level Output Voltage	V <sub>CC</sub> = Min, I <sub>OH</sub> = Max, V <sub>IL</sub> = Max, V <sub>IH</sub> = Min	2.4	3.4		V
V <sub>OL</sub>	Low Level Output Voltage	V <sub>CC</sub> = Min, I <sub>OL</sub> = Max, V <sub>IH</sub> = Min, V <sub>IL</sub> = Max		0.2	0.4	V
I <sub>I</sub>	Input Current @ Max Input Voltage	V <sub>CC</sub> = Max, V <sub>I</sub> = 5.5V			1	mA
I <sub>IH</sub>	High Level Input Current	V <sub>CC</sub> = Max V <sub>I</sub> = 2.4V	A1, A2		40	μA
			B		80	
I <sub>IL</sub>	Low Level Input Current	V <sub>CC</sub> = Max V <sub>I</sub> = 0.4V	A1, A2		-1.6	mA
			B		-3.2	
I <sub>OS</sub>	Short Circuit Output Current	V <sub>CC</sub> = Max (Note 2)	DM54	-20	-55	mA
			DM74	-18	-55	
I <sub>CC</sub>	Supply Current	V <sub>CC</sub> = Max	Quiescent	13	25	mA
			Triggered		23	

Note 1: All typicals are at V<sub>CC</sub> = 5V, T<sub>A</sub> = 25°C.

Note 2: Not more than one output should be shorted at a time.

## Switching Characteristics at $V_{CC} = 5V$ and $T_A = 25^\circ C$ (See Section 1 for Test Waveforms and Output Load)

Symbol	Parameter	From (Input) To (Output)	Conditions	Min	Max	Units
$t_{PLH}$	Propagation Delay Time Low to High Level Output	A1, A2 to Q	$C_{EXT} = 80 \text{ pF}$ $R_{INT} \text{ to } V_{CC}$ $C_L = 15 \text{ pF}$ $R_L = 400\Omega$		70	ns
$t_{PLH}$	Propagation Delay Time Low to High Level Output	B to Q			55	ns
$t_{PHL}$	Propagation Delay Time High to Low Level Output	A1, A2 to $\bar{Q}$			80	ns
$t_{PHL}$	Propagation Delay Time High to Low Level Output	B to $\bar{Q}$			65	ns
$t_{W(OUT)}$	Output Pulse Width Using the Internal Timing Resistor	A1, A2 or B to Q, $\bar{Q}$	$C_{EXT} = 80 \text{ pF}$ $R_{INT} \text{ to } V_{CC}$ $R_L = 400\Omega$ $C_L = 15 \text{ pF}$	70	150	ns
$t_{W(OUT)}$	Output Pulse Width Using Zero Timing Capacitance	A1, A2 to Q, $\bar{Q}$	$C_{EXT} = 0 \text{ pF}$ $R_{INT} \text{ to } V_{CC}$ $R_L = 400\Omega$ $C_L = 15 \text{ pF}$		50	ns
$t_{W(OUT)}$	Output Pulse Width Using External Timing Resistor	A1, A2 to Q, $\bar{Q}$	$C_{EXT} = 100 \text{ pF}$ $R_{INT} = 10 \text{ k}\Omega$ $R_L = 400\Omega$ $C_L = 15 \text{ pF}$	600	800	ns
		A1, A2 to Q, $\bar{Q}$	$C_{EXT} = 1 \mu\text{F}$ $R_{INT} = 10 \text{ k}\Omega$ $R_L = 400\Omega$ $C_L = 15 \text{ pF}$	6	8	ms

## Operating Rules

- To use the internal 2 k $\Omega$  timing resistor, connect the  $R_{INT}$  pin to  $V_{CC}$ .
- An external resistor ( $R_X$ ) or the internal resistor (2 k $\Omega$ ) and an external capacitor ( $C_X$ ) are required for proper operation. The value of  $C_X$  may vary from 0 to any necessary value. For small time constants use high-quality mica, glass, polypropylene, polycarbonate, or polystyrene capacitors. For large time constants use solid tantalum or special aluminum capacitors. If the timing capacitors have leakages approaching 100 nA or if stray capacitance from either terminal to ground is greater than 50 pF the timing equations may not represent the pulse width the device generates.
- The pulse width is essentially determined by external timing components  $R_X$  and  $C_X$ . For  $C_X < 1000 \text{ pF}$  see *Figure 1* design curves on  $T_W$  as function of timing components value. For  $C_X > 1000 \text{ pF}$  the output is defined as:

$$t_W = K R_X C_X$$

where [ $R_X$  is in Kilo-ohm]

[ $C_X$  is in pico Farad]

[ $T_W$  is in nano second]

[ $K \approx 0.7$ ]

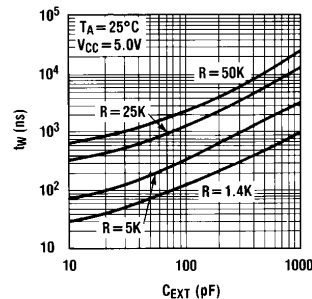

TL/F/6538-2

FIGURE 1

- If  $C_X$  is an electrolytic capacitor a switching diode is often required for standard TTL one-shots to prevent high inverse leakage current (*Figure 2*).

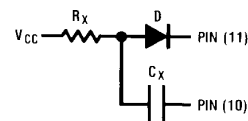

FIGURE 2

TL/F/6538-3

## Operating Rules (Continued)

5. Output pulse width versus  $V_{CC}$  and operation temperatures: *Figure 3* depicts the relationship between pulse width variation versus  $V_{CC}$ . *Figure 4* depicts pulse width variation versus ambient temperature.

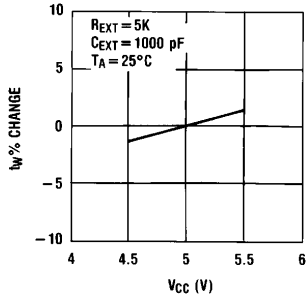

FIGURE 3

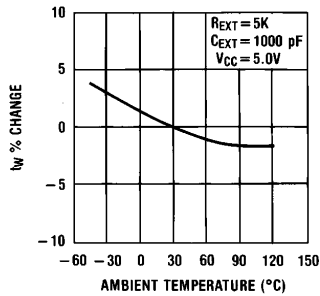

FIGURE 4

6. The "K" coefficient is not a constant, but varies as a function of the timing capacitor  $C_X$ . *Figure 5* details this characteristic.

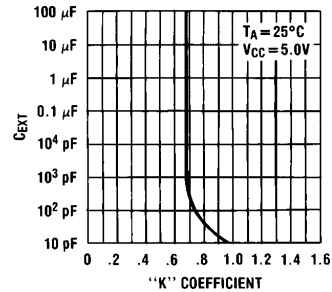

FIGURE 5

7. Under any operating condition  $C_X$  and  $R_X$  must be kept as close to the one-shot device pins as possible to minimize stray capacitance, to reduce noise pick-up, and to reduce  $I \times R$  and  $L di/dt$  voltage developed along their connecting paths. If the lead length from  $C_X$  to pins (10) and (11) is greater than 3 cm, for example, the output pulse width might be quite different from values predicted from the appropriate equations. A non-inductive and low capacitive path is necessary to ensure complete discharge of  $C_X$  in each cycle of its operation so that the output pulse width will be accurate.

8.  $V_{CC}$  and ground wiring should conform to good high-frequency standards and practices so that switching transients on the  $V_{CC}$  and ground return leads do not cause interaction between one-shots. A  $0.01 \text{ }\mu\text{F}$  to  $0.10 \text{ }\mu\text{F}$  bypass capacitor (disk ceramic or monolithic type) from  $V_{CC}$  to ground is necessary on each device. Furthermore, the bypass capacitor should be located as close to the  $V_{CC}$ -pin as space permits.

For further detailed device characteristics and output performance please refer to the NSC one-shot application note, AN-366.

**Physical Dimensions** inches (millimeters)

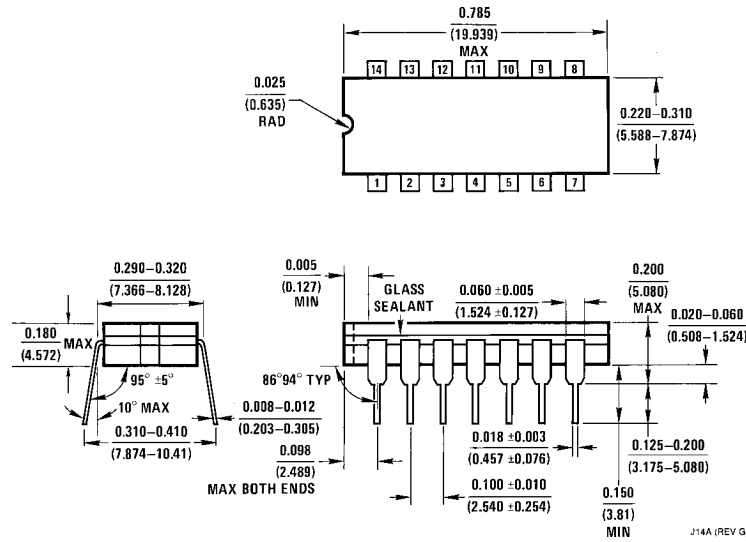

**14-Lead Ceramic Dual-In-Line Package (J)**  
**Order Number 54121DMQB or DM54121J**  
**NS Package Number J14A**

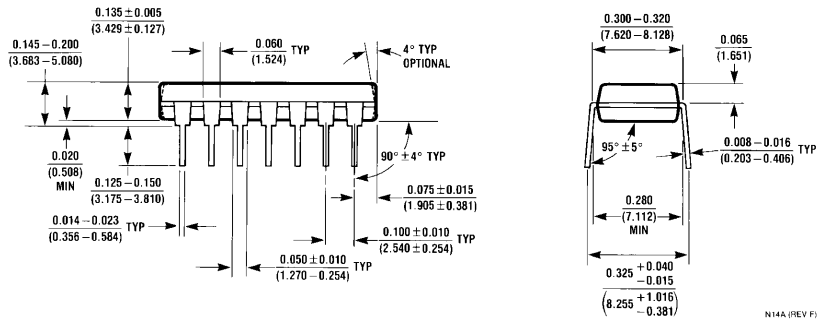
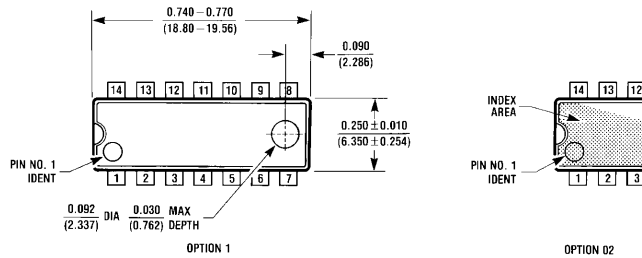

**14-Lead Molded Dual-In-Line Package (N)**  
**Order Number DM74121N**  
**NS Package Number N14A**

**Physical Dimensions** inches (millimeters) (Continued)

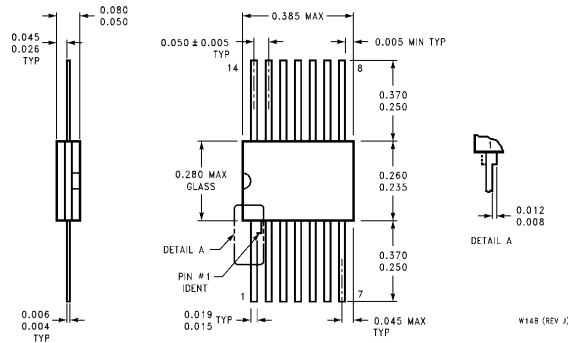

**14-Lead Ceramic Flat Package (W)**  
**Order Number 54121FMQB or DM54121W**  
**NS Package Number W14B**

**LIFE SUPPORT POLICY**

NATIONAL'S PRODUCTS ARE NOT AUTHORIZED FOR USE AS CRITICAL COMPONENTS IN LIFE SUPPORT DEVICES OR SYSTEMS WITHOUT THE EXPRESS WRITTEN APPROVAL OF THE PRESIDENT OF NATIONAL SEMICONDUCTOR CORPORATION. As used herein:

1. Life support devices or systems are devices or systems which, (a) are intended for surgical implant into the body, or (b) support or sustain life, and whose failure to perform, when properly used in accordance with instructions for use provided in the labeling, can be reasonably expected to result in a significant injury to the user.
2. A critical component is any component of a life support device or system whose failure to perform can be reasonably expected to cause the failure of the life support device or system, or to affect its safety or effectiveness.



**National Semiconductor Corporation**  
 1111 West Bardin Road  
 Arlington, TX 76017  
 Tel: 1(800) 272-9959  
 Fax: 1(800) 737-7018

**National Semiconductor Europe**  
 Fax: (+49) 0-180-530 85 86  
 Email: cnjwge@tevm2.nsc.com  
 Deutsch Tel: (+49) 0-180-530 85 85  
 English Tel: (+49) 0-180-532 78 32  
 Français Tel: (+49) 0-180-532 93 58  
 Italiano Tel: (+49) 0-180-534 16 80

**National Semiconductor Hong Kong Ltd.**  
 19th Floor, Straight Block,  
 Ocean Centre, 5 Canton Rd.  
 Tsimshatsui, Kowloon  
 Hong Kong  
 Tel: (852) 2737-1600  
 Fax: (852) 2736-9960

**National Semiconductor Japan Ltd.**  
 Tel: 81-043-299-2309  
 Fax: 81-043-299-2408

National does not assume any responsibility for use of any circuitry described, no circuit patent licenses are implied and National reserves the right at any time without notice to change said circuitry and specifications.