

Features

- High surge current capability
- Designed for a wide range of applications
- Stud cathode and stud anode version
- Leaded version available
- Types up to 1600V V_{RRM}

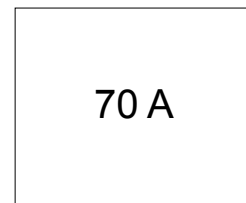

Typical Applications

- Battery charges
- Converters
- Power supplies
- Machine tool controls

Major Ratings and Characteristics

Parameters	70HF(R)		Units
	10 to 120	140 to 160	
$I_{F(AV)}$	70	70	A
@ T_C	140	110	°C
$I_{F(RMS)}$	110		A
I_{FSM} @ 50Hz	1200		A
@ 60Hz	1250		A
I^2t @ 50Hz	7100		A ² s
@ 60Hz	6450		A ² s
V_{RRM} range	100 to 1200	1400 to 1600	V
T_J range	- 65 to 180	- 65 to 150	°C



70HF(R) Series

Bulletin I20202 rev. F 01/05

International
IR Rectifier

ELECTRICAL SPECIFICATIONS

Voltage Ratings

Type number	Voltage Code	V_{RRM} , maximum repetitive peak reverse voltage V	V_{RSM} , maximum non-repetitive peak reverse voltage V	$V_{R(BR)}$, minimum avalanche voltage V	I_{RRM} max. @ $T_J = T_J$ max. mA
70HF(R)	10	100	200	200	15
	20	200	300	300	
	40	400	500	500	
	60	600	720	725	9
	80	800	960	950	
	100	1000	1200	1150	
	120	1200	1440	1350	
	140	1400	1650	1550	4.5
160	1600	1900	1750		

Forward Conduction

Parameter	70HF(R)		Units	Conditions	
	10 to 120	140 to 160			
$I_{F(AV)}$ Max. average forward current @ Case temperature	70	70	A	180° conduction, half sine wave	
	140	110	°C		
$I_{F(RMS)}$ Max. RMS forward current	110		A		
I_{FSM} Max. peak, one-cycle forward, non-repetitive surge current	1200		A	t = 10ms	No voltage reappplied
	1250			t = 8.3ms	
	1000			t = 10ms	100% V_{RRM} reappplied
	1050			t = 8.3ms	
I^2t Maximum I^2t for fusing	7100		A ² s	t = 10ms	No voltage reappplied
	6450			t = 8.3ms	
	5000			t = 10ms	100% V_{RRM} reappplied
	4550			t = 8.3ms	
I^2/t Maximum I^2/t for fusing	71000		A ² /s	t = 0.1 to 10ms, no voltage reappplied	
$V_{F(TO)1}$ Low level value of threshold voltage	0.79		V	(16.7% $\times \pi \times I_{F(AV)} < I < \pi \times I_{F(AV)}$), $T_J = T_J$ max.	
$V_{F(TO)2}$ High level value of threshold voltage	1.00			(I $> \pi \times I_{F(AV)}$), $T_J = T_J$ max.	
r_{f1} Low level value of forward slope resistance	2.33		m Ω	(16.7% $\times \pi \times I_{F(AV)} < I < \pi \times I_{F(AV)}$), $T_J = T_J$ max.	
r_{f2} High level value of forward slope resistance	1.53			(I $> \pi \times I_{F(AV)}$), $T_J = T_J$ max.	
V_{FM} Max. forward voltage drop	1.35	1.46	V	$I_{pk} = 220A$, $T_J = 25^\circ C$, $t_p = 400\mu s$ rectangular wave	

Thermal and Mechanical Specifications

Parameter	70HF(R)		Units	Conditions
	10 to 120	140 to 160		
T _J Max. junction operating temperature range	-65 to 180	-65 to 150	°C	
T _{stg} Max. storage temperature range	-65 to 180	-65 to 150		
R _{thJC} Max. thermal resistance, junction to case	0.45		K/W	DC operation
R _{thCS} Max. thermal resistance, case to heatsink	0.25			Mounting surface, smooth, flat and greased
T Allowable mounting torque	3.4 ^{+0-10%}		Nm	Not lubricated threads
			lbf·in	
	2.3 ^{+0-10%}		Nm	Lubricated threads
			lbf·in	
wt Approximate weight	17 (0.6)		g (oz)	
Case style	DO-203AB (DO5)			See Outline Table

ΔR_{thJC} Conduction

(The following table shows the increment of thermal resistance R_{thJC} when devices operate at different conduction angles than DC)

Conduction angle	Sinusoidal conduction	Rectangular conduction	Units	Conditions
180°	0.08	0.06	K/W	T _J = T _J max.
120°	0.10	0.11		
90°	0.13	0.14		
60°	0.19	0.20		
30°	0.30	0.30		

Ordering Information Table

Device Code

70	HF	R	160	M
1	2	3	4	5

- 1** - 70 = Standard device
71 = Not isolated lead
72 = Isolated lead with silicone sleeve
(Red = Reverse polarity)
(Blue = Normal polarity)
- 2** - HF = Standard diode
- 3** - None = Stud Normal Polarity (Cathode to Stud)
R = Stud Reverse Polarity (Anode to Stud)
- 4** - Voltage code: Code x 10 = V_{RRM} (See Voltage Ratings table)
- 5** - None = Stud base DO-203AB (DO-5) 1/4" 28UNF-2A
M = Stud base DO-203AB (DO-5) M6 X 1

70HF(R) Series

Bulletin I20202 rev. F 01/05

Outlines Table

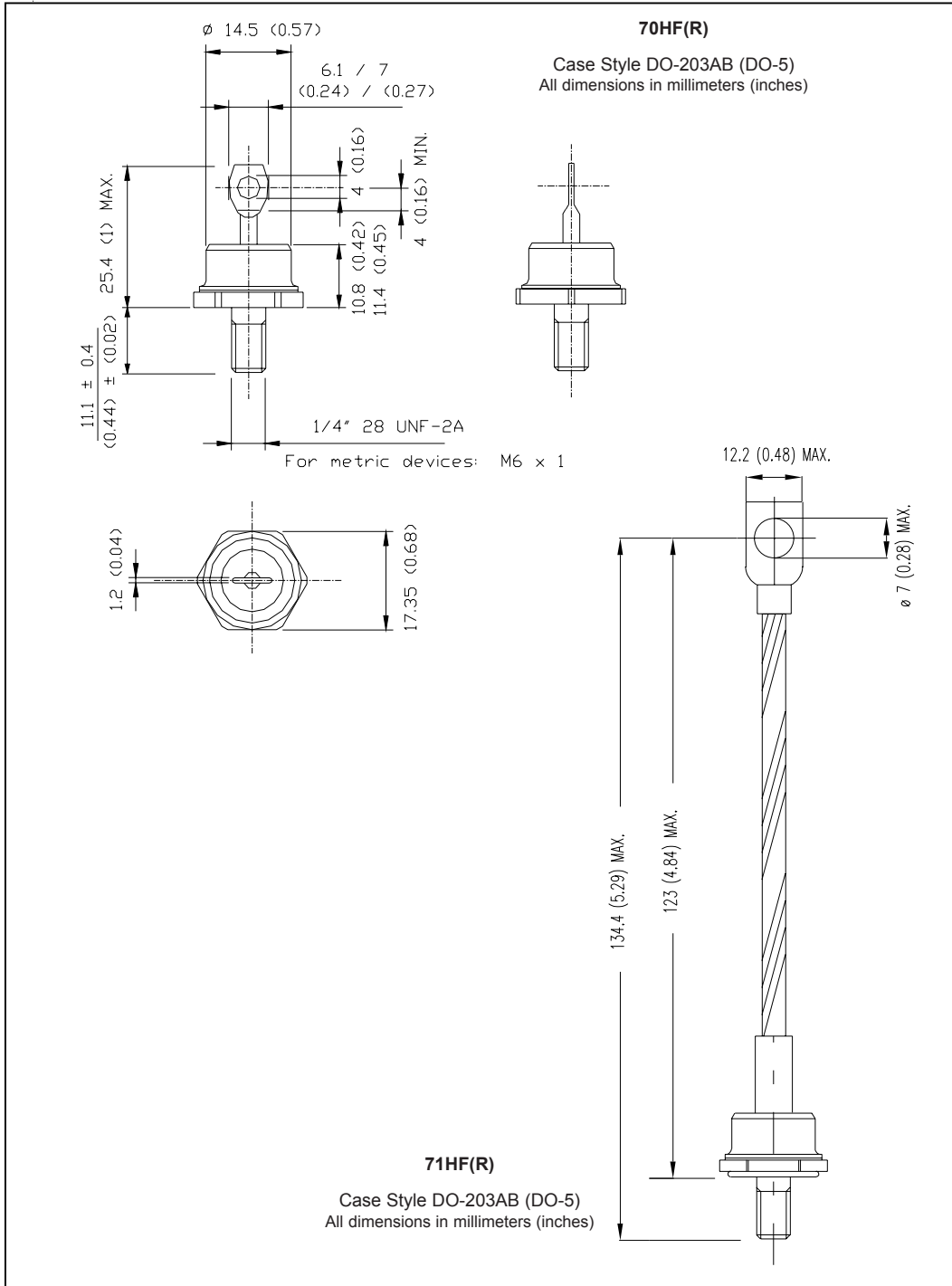

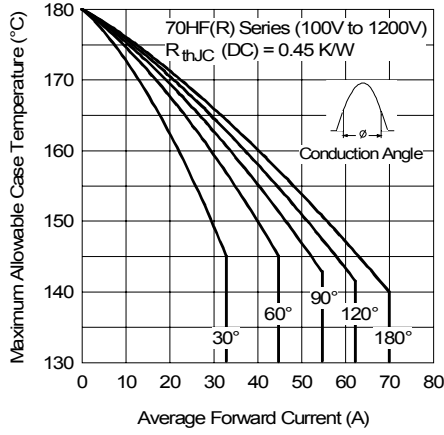

Fig. 1 - Current Ratings Characteristics

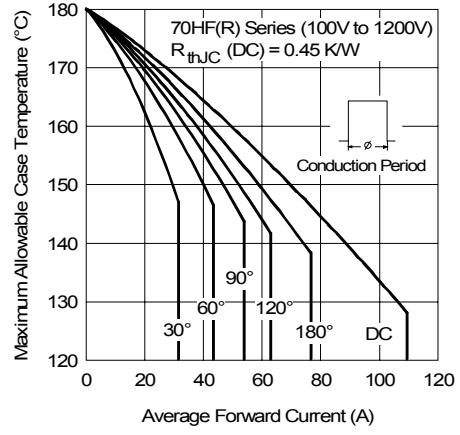

Fig. 2 - Current Ratings Characteristics

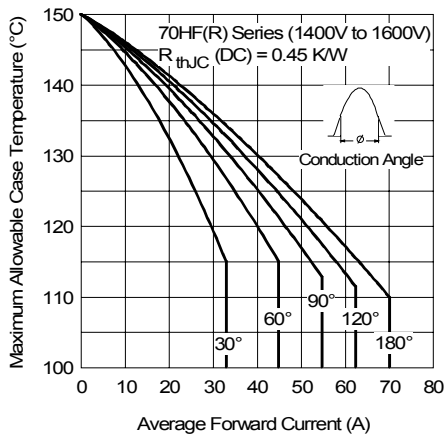

Fig. 3 - Current Ratings Characteristics

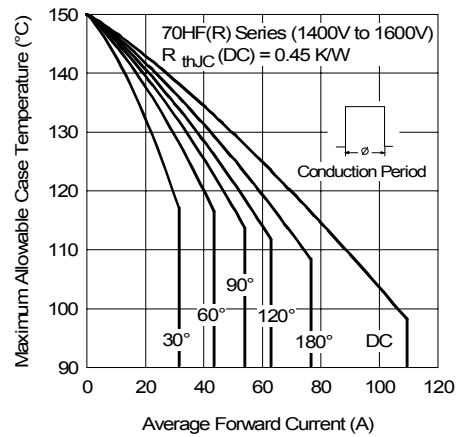

Fig. 4 - Current Ratings Characteristics



Fig. 5 - Forward Power Loss Characteristics

70HF(R) Series

Bulletin I20202 rev. F 01/05

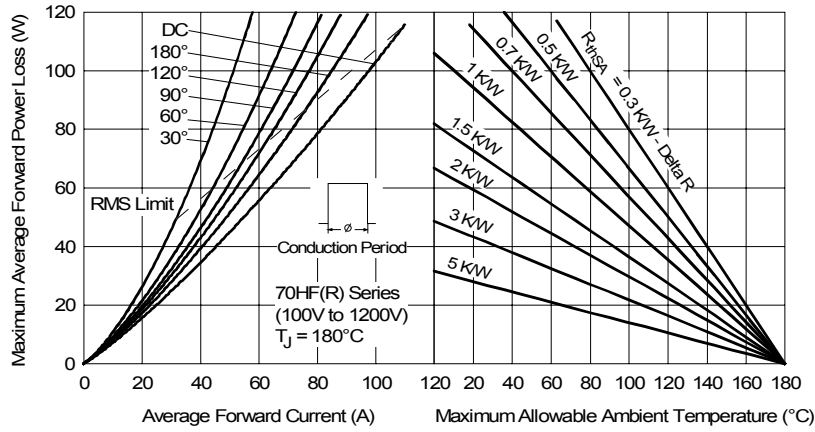

Fig. 6 - Forward Power Loss Characteristics

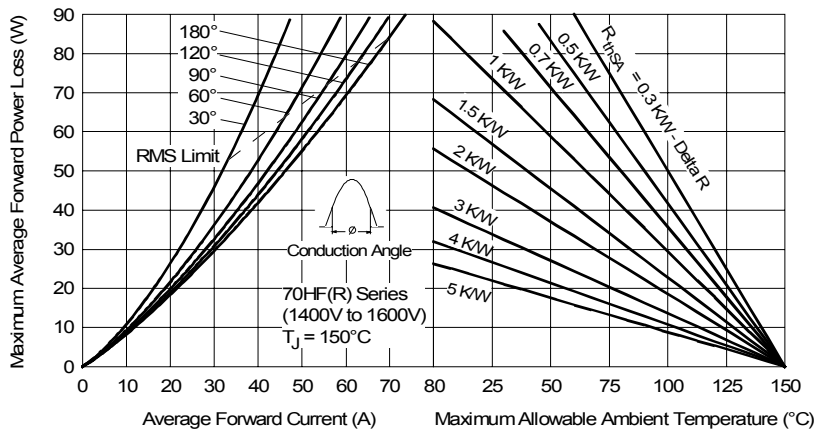

Fig. 7 - Forward Power Loss Characteristics



Fig. 8 - Forward Power Loss Characteristics



Fig. 9 - Maximum Non-Repetitive Surge Current

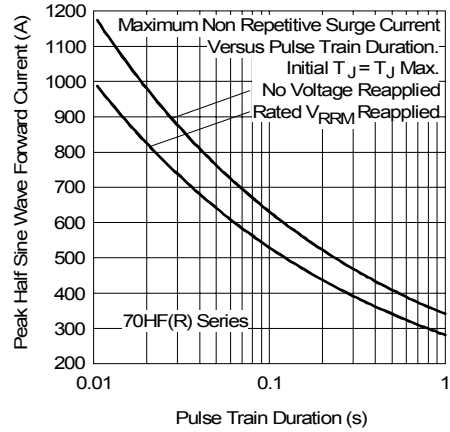

Fig. 10 - Maximum Non-Repetitive Surge Current

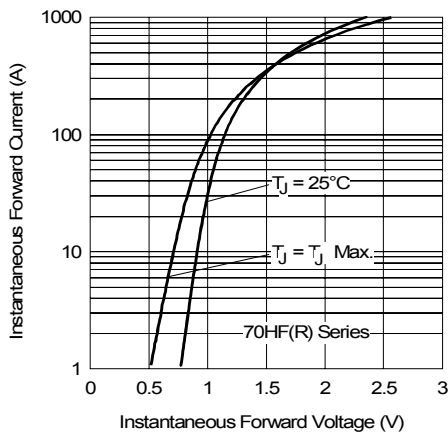

Fig. 11 - Forward Voltage Drop Characteristics

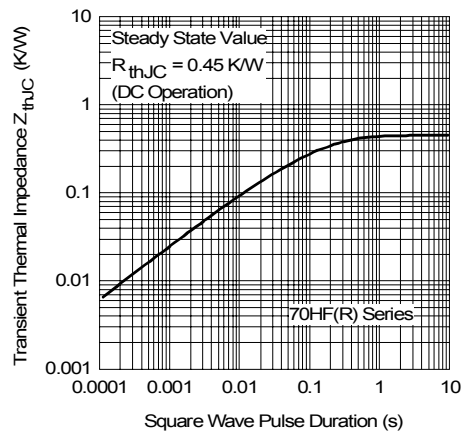

Fig. 12 - Thermal Impedance Z_{thjC} Characteristics



Fig. 13 - Forward Voltage Drop Characteristics

70HF(R) Series

Bulletin I20202 rev. F 01/05

International
IOR Rectifier

Data and specifications subject to change without notice.
This product has been designed and qualified for Industrial Level.
Qualification Standards can be found on IR's Web site.

International
IOR Rectifier

IR WORLD HEADQUARTERS: 233 Kansas St., El Segundo, California 90245, USA Tel: (310) 252-7105
TAC Fax: (310) 252-7309
Visit us at www.irf.com for sales contact information. 01/05