

STANDARD RECOVERY DIODES

Stud Version

Features

- Wide current range
- High surge current capabilities
- Stud cathode and stud anode version
- Standard JEDEC types

400A

Typical Applications

- Converters
- Power supplies
- Machine tool controls
- High power drives

Major Ratings and Characteristics

Parameters	400U/R	Units
$I_{F(AV)}$	400	A
@ T_C	120	°C
$I_{F(RMS)}$	630	A
I_{FSM} @ 50Hz	8250	A
@ 60Hz	8640	A
I^2t @ 50Hz	340	KA ² s
@ 60Hz	311	KA ² s
V_{RRM} range	800 to 1600	V
T_J	- 40 to 200	°C

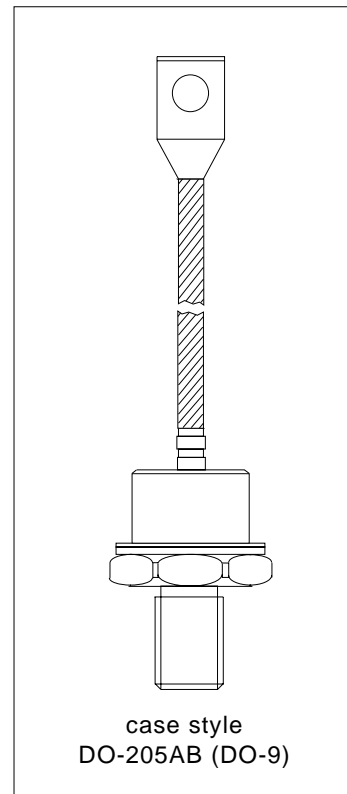

400U(R) Series

Bulletin I2059 rev. C 03/03

International
IR Rectifier

ELECTRICAL SPECIFICATIONS

Voltage Ratings

Type number	Voltage Code	V_{RRM} , maximum repetitive peak reverse voltage V	V_{RSM} , maximum non-repetitive peak rev. voltage V	I_{RRM} max. @ $T_J = T_J$ max. mA
400U(R)	80	800	900	15
	120	1200	1300	
	160	1600	1700	

Forward Conduction

Parameter	400U(R)	Units	Conditions
$I_{F(AV)}$ Max. average forward current @ Case temperature	400	A	180° conduction, half sine wave
	120	°C	
$I_{F(RMS)}$ Max. RMS forward current	630	A	DC @ 110°C case temperature
I_{FSM} Max. peak, one-cycle forward, non-repetitive surge current	8250	A	t = 10ms No voltage
	8640		t = 8.3ms reapplied
	6940		t = 10ms 100% V_{RRM}
	7270		t = 8.3ms reapplied
I^2t Maximum I^2t for fusing	340	KA ² s	t = 10ms No voltage
	311		t = 8.3ms reapplied
	241		t = 10ms 100% V_{RRM}
	220		t = 8.3ms reapplied
$I^2\sqrt{t}$ Maximum $I^2\sqrt{t}$ for fusing	3400	KA ² √s	t = 0.1 to 10ms, no voltage reapplied
$V_{F(TO)1}$ Low level value of threshold voltage	0.77	V	($16.7\% \times \pi \times I_{F(AV)} < I < \pi \times I_{F(AV)}$), $T_J = T_J$ max.
$V_{F(TO)2}$ High level value of threshold voltage	0.85		($I > \pi \times I_{F(AV)}$), $T_J = T_J$ max.
r_{f1} Low level value of forward slope resistance	0.49	mΩ	($16.7\% \times \pi \times I_{F(AV)} < I < \pi \times I_{F(AV)}$), $T_J = T_J$ max.
r_{f2} High level value of forward slope resistance	0.49		($I > \pi \times I_{F(AV)}$), $T_J = T_J$ max.
V_{FM} Max. forward voltage drop	1.62	V	$I_{pk} = 1500A$, $T_J = T_J$ max, $t_p = 10ms$ sinusoidal wave

Thermal and Mechanical Specifications

Parameter	400U(R)	Units	Conditions
T_J Max. junction operating temperature range	-40 to 200	°C	
T_{stg} Max. storage temperature range	-40 to 200		
R_{thJC} Max. thermal resistance, junction to case	0.15	K/W	DC operation
R_{thCS} Max. thermal resistance, case to heatsink	0.04		Mounting surface, smooth, flat and greased
T Max. allowed mounting torque ±10%	27	Nm	Not lubricated threads
wt Approximate weight	250	g	
Case style	DO-205AB (DO-9)		See Outline Table

ΔR_{thJC} Conduction

(The following table shows the increment of thermal resistance R_{thJC} when devices operate at different conduction angles than DC)

Conduction angle	Sinusoidal conduction	Rectangular conduction	Units	Conditions
180°	0.020	0.013	K/W	$T_J = T_{J \text{ max.}}$
120°	0.023	0.023		
90°	0.029	0.031		
60°	0.042	0.044		
30°	0.073	0.074		

Ordering Information Table

Device Code

40	0	U	R	160	D
1	2	3	4	5	6

- 1** - 40 = Essential Part Number
- 2** - 0 = Standard Recovery Device
- 3** - U = Stud Normal Polarity (Cathode to Stud)
- 4** - None = Stud Normal Polarity (Cathode to Stud)
R = Stud Reverse Polarity (Anode to Stud)
- 5** - Voltage code: Code x 10 = V_{RRM} (See Voltage Ratings table)
- 6** - Diffused diode

NOTE: For Metric device M16 x 1.5 Contact Factory

Outline Table

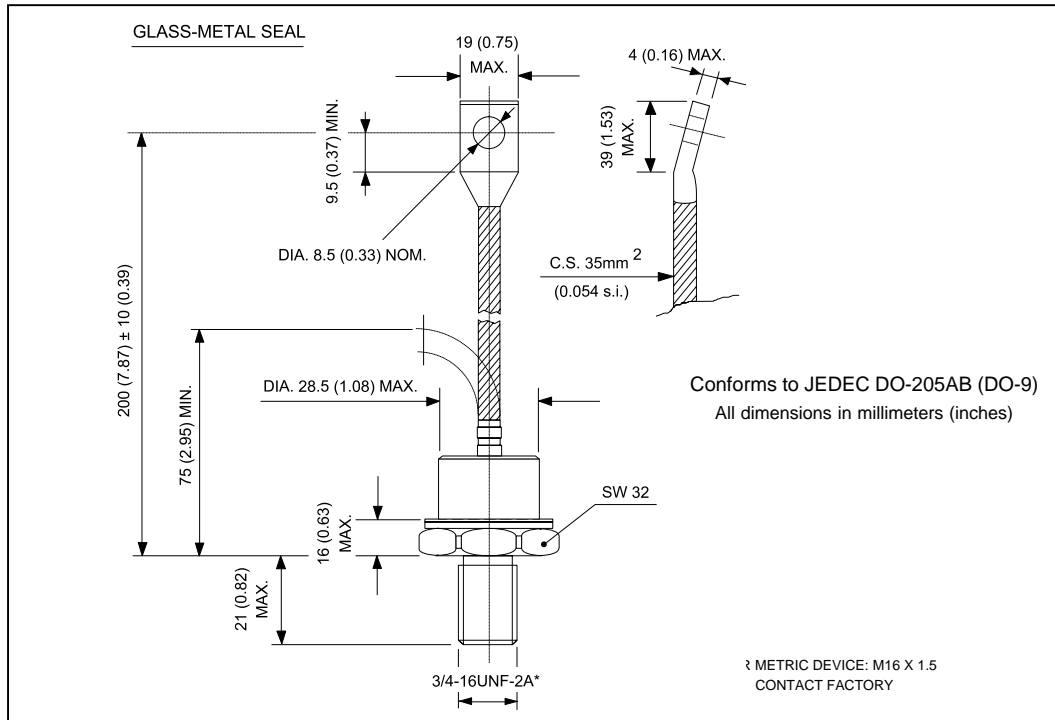

400U(R) Series

Bulletin I2059 rev. C 03/03

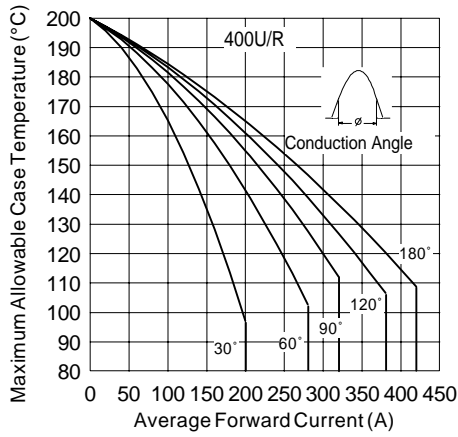

Fig. 1 - Current Ratings Characteristics

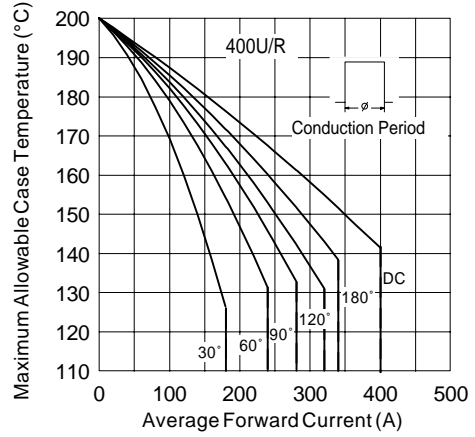

Fig. 2 - Current Ratings Characteristics

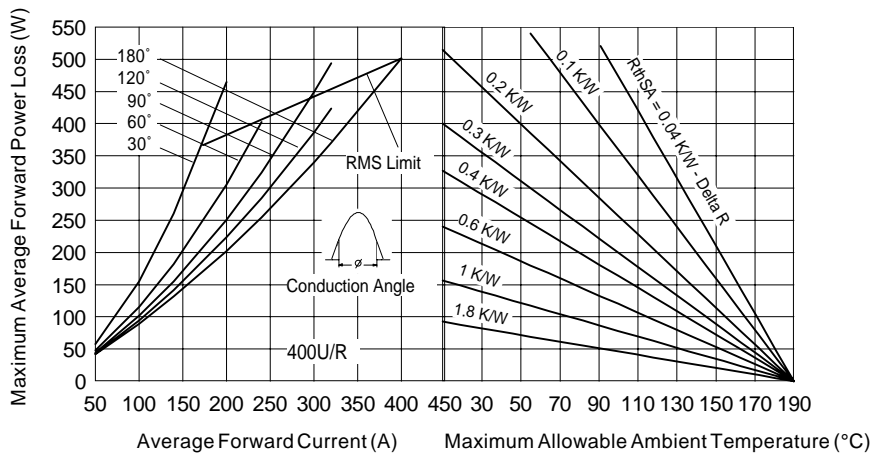

Fig. 3 - Forward Power Loss Characteristics

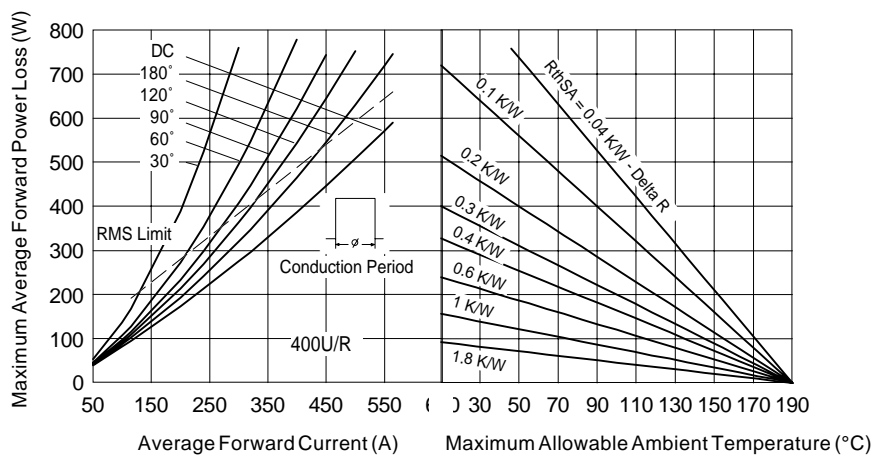

Fig. 4 - Forward Power Loss Characteristics

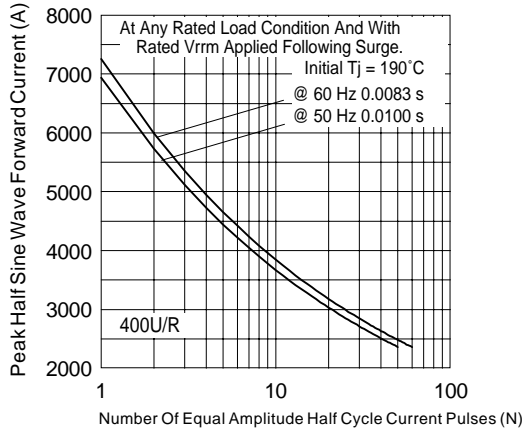

Fig. 5 - Maximum Non-Repetitive Surge Current

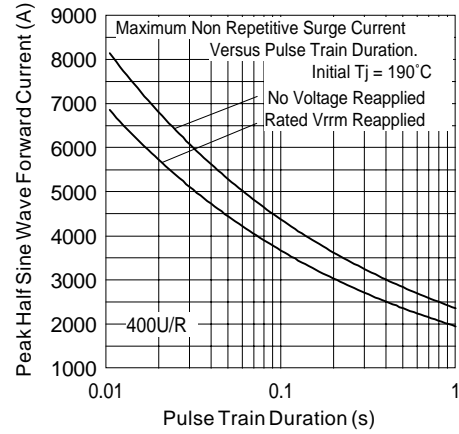

Fig. 6 - Maximum Non-Repetitive Surge Current

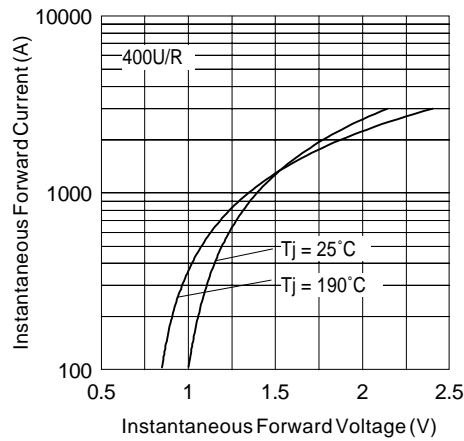

Fig. 7 - Forward Voltage Drop Characteristics

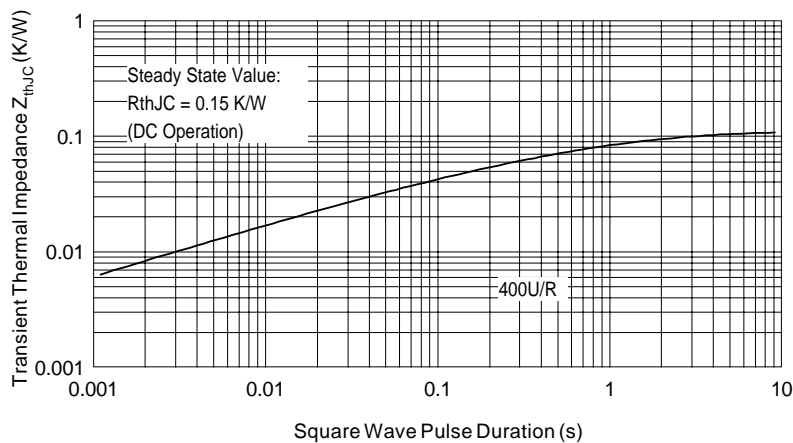

Fig. 8 - Thermal Impedance Z_{thJC} Characteristic

400U(R) Series

Bulletin I2059 rev. C 03/03

International
IR Rectifier

Data and specifications subject to change without notice.
This product has been designed and qualified for Industrial Level.
Qualification Standards can be found on IR's Web site.

International
IR Rectifier

IR WORLD HEADQUARTERS: 233 Kansas St., El Segundo, California 90245, USA Tel: (310) 252-7105
TAC Fax: (310) 252-7309
Visit us at www.irf.com for sales contact information. 03/03