

### STANDARD RECOVERY DIODES

Stud Version

#### Features

- Alloy diode
- Peak reverse voltage up to 1000V
- Popular series for rough service
- Standard JEDEC types
- Stud cathode and stud anode version

250A  
300A

#### Typical Applications

- Welders
- Power supplies
- Motor controls
- Battery chargers
- General industrial current rectification

#### Major Ratings and Characteristics

Parameters	70U	300U	Units
$I_{F(AV)}$	250	300	A
@ $T_C$	150	130	°C
$I_{FSM}$ @ 50Hz	6550		A
@ 60Hz	6850		A
$I^2t$ @ 50Hz	214		KA <sup>2</sup> s
@ 60Hz	195		KA <sup>2</sup> s
$V_{RRM}$ range	100 to 1000	50 to 1000	V
$T_J$	-65 to 200		°C

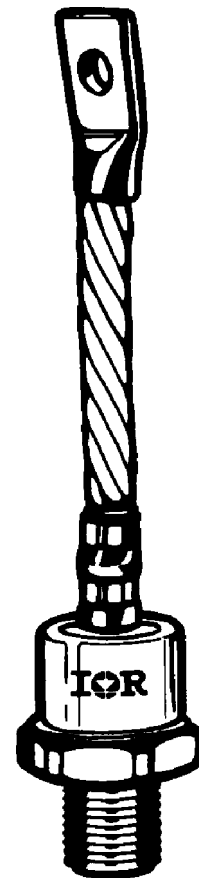

case style  
DO-205AB (DO-9)

**ELECTRICAL SPECIFICATIONS**

## Voltage Ratings

Type number *	Voltage Code	$V_{RRM}$ , maximum repetitive peak reverse voltage V	$V_{RSM}$ , maximum non-repetitive peak rev. voltage V	$I_{RRM}$ max. $T_J = 200^\circ\text{C}$ mA
70U	10	100	200	60
	20	200	300	
	40	400	500	
	60	600	720	
	80	800	960	
	100	1000	1200	
Type number	Voltage Code	$V_{RRM}$ , maximum repetitive peak reverse voltage V	$V_{RSM}$ , maximum non-repetitive peak rev. voltage V	$I_{RRM}$ max. $T_J = 175^\circ\text{C}$ mA
300U	5	50	100	40
	10	100	200	40
	20	200	300	40
	30	300	400	40
	40	400	500	40
	60	600	720	40
	80	800	960	35
	100	1000	1200	30

\* Also available as JEDEC series: 1N3735 through 1N3743; 1N2054 through 1N2068; 1N4044 through 1N4056.

## Forward Conduction

Parameter	70U	300U	Units	Conditions
$I_{F(AV)}$ Max. average forward current @ Case temperature	250	300	A	180° conduction, half sine wave
	150	130	°C	
$I_{FSM}$ Max. peak, one-cycle forward, non-repetitive surge current	6550	A	A	t = 10ms No voltage reappplied
	6850			t = 8.3ms reappplied
	5500			t = 10ms 100% $V_{RRM}$
	5750			t = 8.3ms reappplied
$I^2t$ Maximum $I^2t$ for fusing	214	KA <sup>2</sup> s	KA <sup>2</sup> s	t = 10ms No voltage reappplied
	195			t = 8.3ms reappplied
	151			t = 10ms 100% $V_{RRM}$
	138			t = 8.3ms reappplied
$I^2\sqrt{t}$ Maximum $I^2\sqrt{t}$ for fusing	2140		KA <sup>2</sup> √s	t = 0.1 to 10ms, no voltage reappplied
$V_{F(TO)}$ Max. value of threshold voltage	0.610		V	$T_J = 200^\circ\text{C}$
$r_f$ Max. value of forward slope resistance	0.751		mΩ	
$V_{FM}$ Max. peak forward voltage	1.30	--	V	$(I_{FM} \times \pi \times I_{F(AV)})$ (785A peak), $T_J = 25^\circ\text{C}$
	--	1.40	V	$(I_{FM} \times \pi \times I_{F(AV)})$ (942A peak), $T_J = 25^\circ\text{C}$

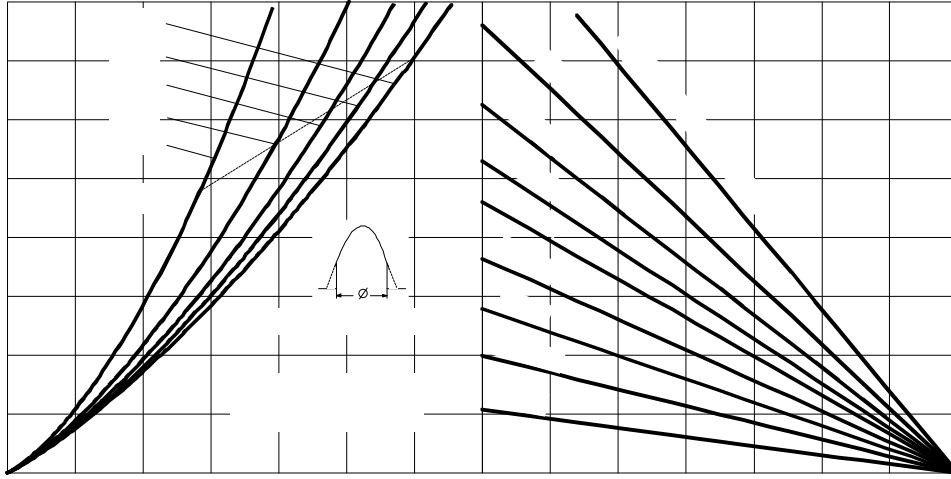

Fig. 3 - Forward Power Loss Characteristics

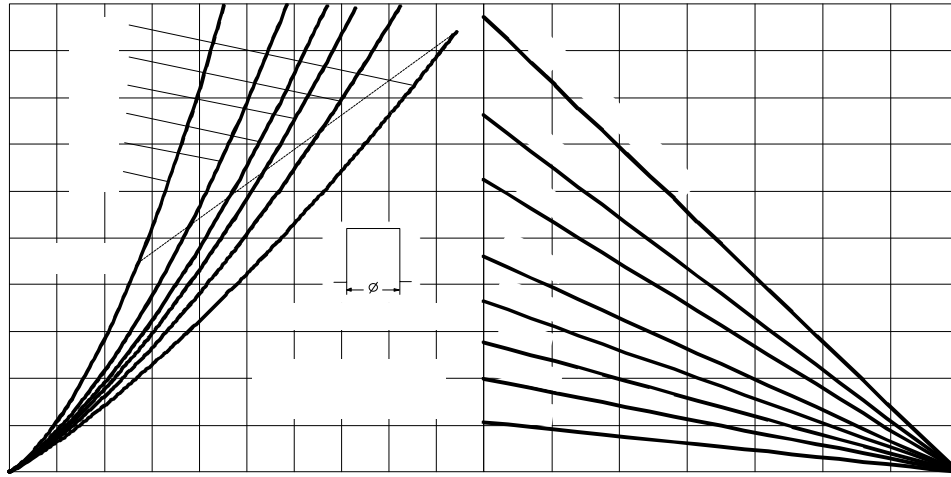
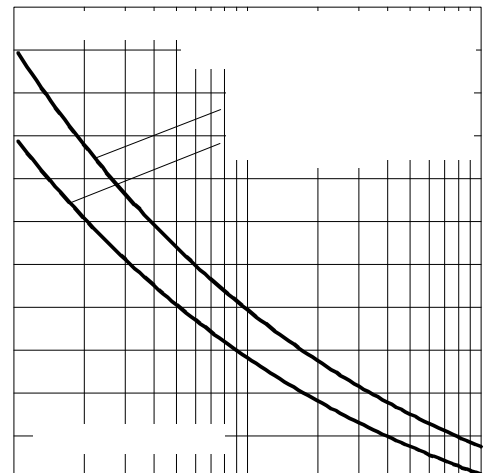
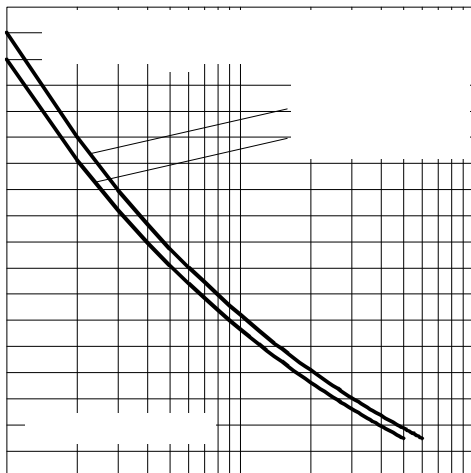

Fig. 4 - Forward Power Loss Characteristics



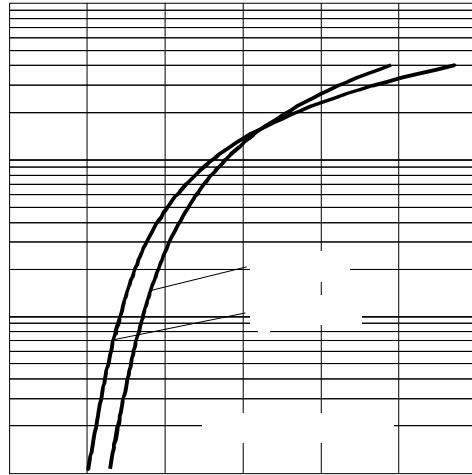
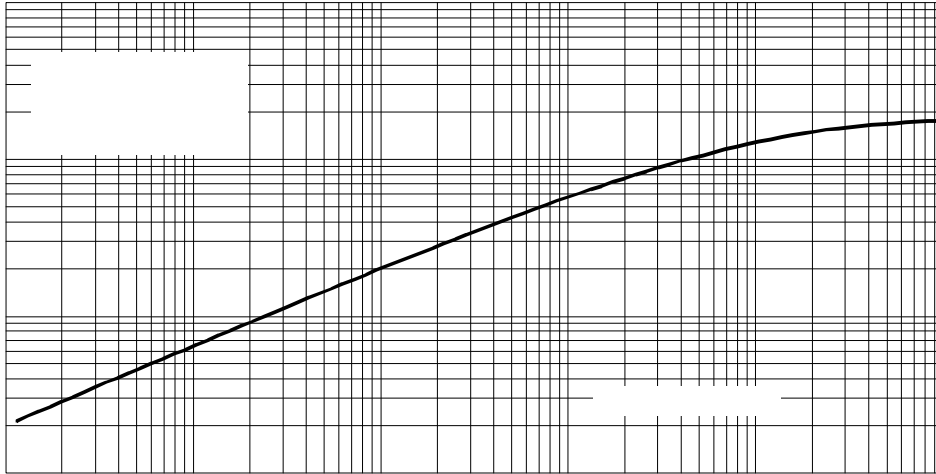

Fig. 7 - Forward Voltage Drop Characteristics

Fig. 8 - Thermal Impedance  $Z_{thJC}$  Characteristic

## Thermal and Mechanical Specifications

Parameter	70/300U(R)	Units	Conditions
$T_J$ Max. junction operating temperature range	-65 to 200	°C	
$T_{stg}$ Max. storage temperature range	-65 to 200		
$R_{thJC}$ Max. thermal resistance, junction to case	0.18	K/W	DC operation
$R_{thCS}$ Max. thermal resistance, case to heatsink	0.08		Mounting surface, smooth, flat and greased
$T$ Max. allowed mounting torque +0 -20%	37	Nm	Not lubricated threads
	28		Lubricated threads
wt Approximate weight	250	g	
Case style	DO-205AB (DO-9)**		JEDEC (See Outline Table)

\*\* 302U-A uses IR case style B-26

 $\Delta R_{thJC}$  Conduction

(The following table shows the increment of thermal resistance  $R_{thJC}$  when devices operate at different conduction angles than DC)

Conduction angle	Sinusoidal conduction	Rectangular conduction	Units	Conditions
180°	0.020	0.015	K/W	$T_J = T_J \text{ max.}$
120°	0.024	0.025		
90°	0.031	0.034		
60°	0.045	0.047		
30°	0.077	0.077		

## Ordering Information Table

## Device Code

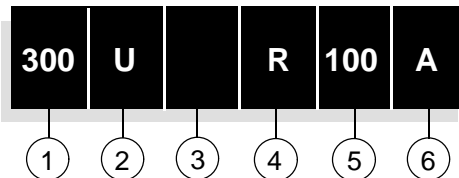

- 1** - 300 = Standard 300U device  
70 = Standard 70U device  
302 = 300U Top Threaded version  
72 = 70U with Pinch Bolt
- 2** - U = Essential Part Number
- 3** - F = Flat Base, available only on 72UF Series  
None = Normal Stud
- 4** - R = Stud Reverse Polarity (Anode to Stud)  
None = Stud Normal Polarity (Cathode to Stud)
- 5** - Voltage code: Code x 10 =  $V_{RRM}$  (See Voltage Ratings table)
- 6** - A = Essential Part Number only for 300U Series  
None = 70U Series

NOTE: For longer lead Contact Factory

# 70/300U(R) Series

## Outline Table

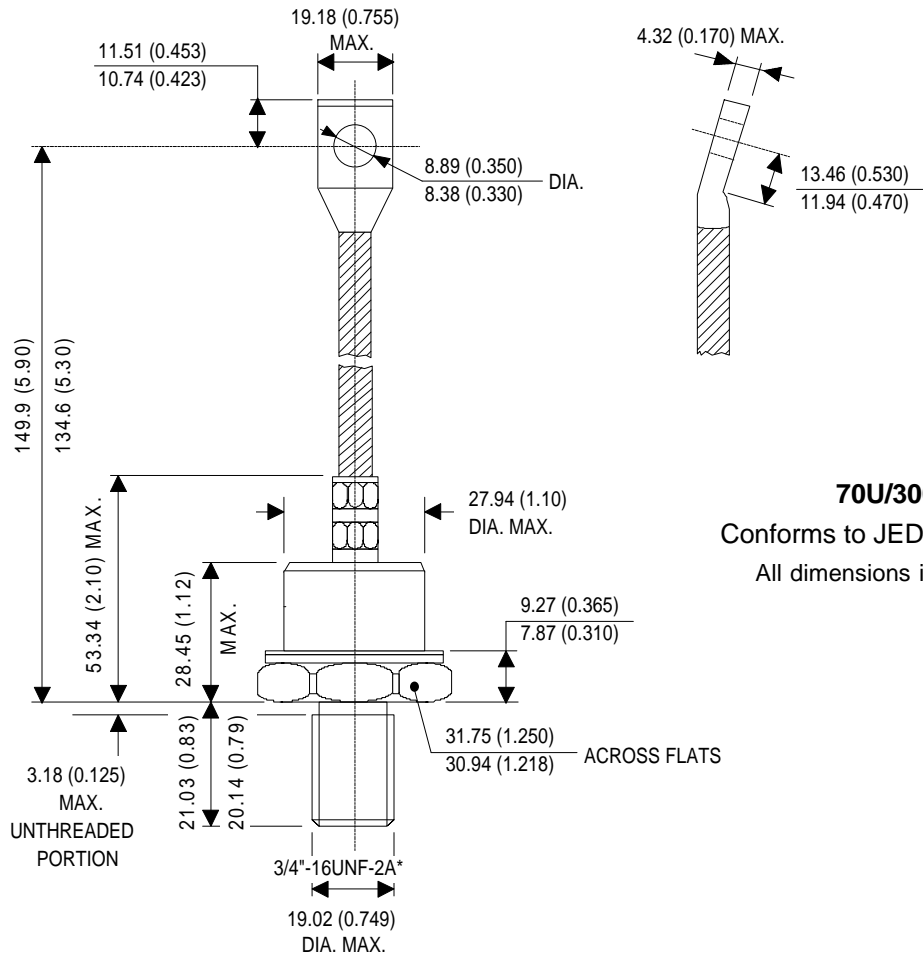

**70U/300U-A Series**  
 Conforms to JEDEC DO-205AB (DO-9)  
 All dimensions in millimeters (inches)

\* METRIC DEVICE. M16 X 1.5 FOR 300U..AM  
 METRIC DEVICE. M20 X 1.5 FOR 300U..AMA

**302U-A Series**  
 IR Case Style B26  
 All dimensions in millimeters (inches)

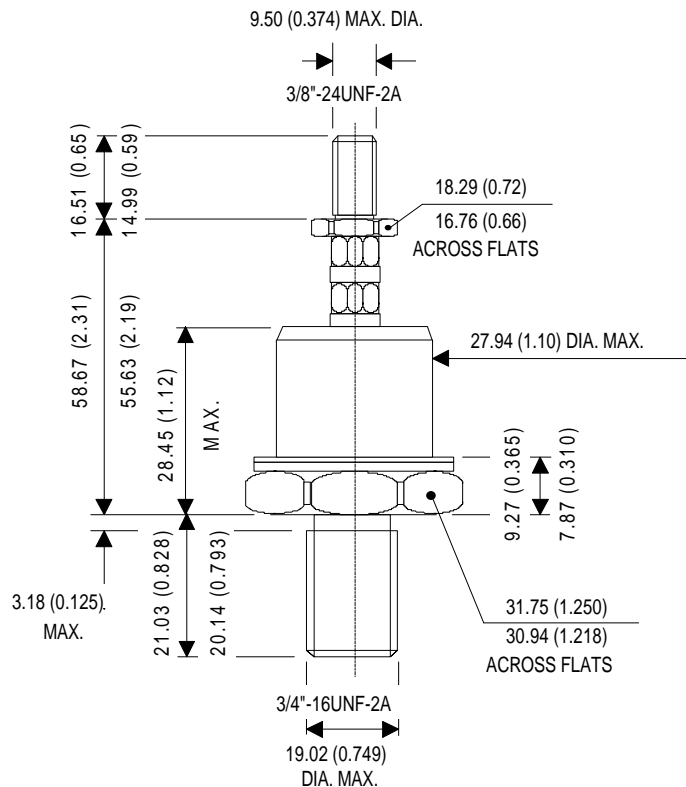

Outline Table

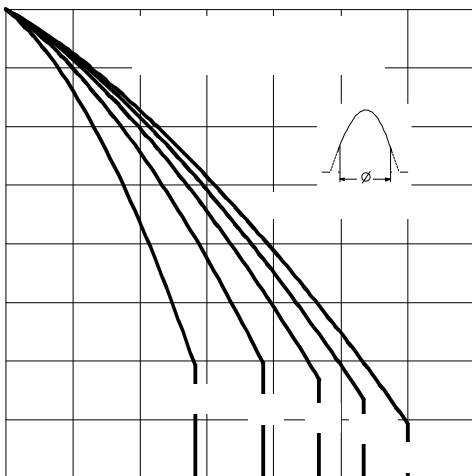
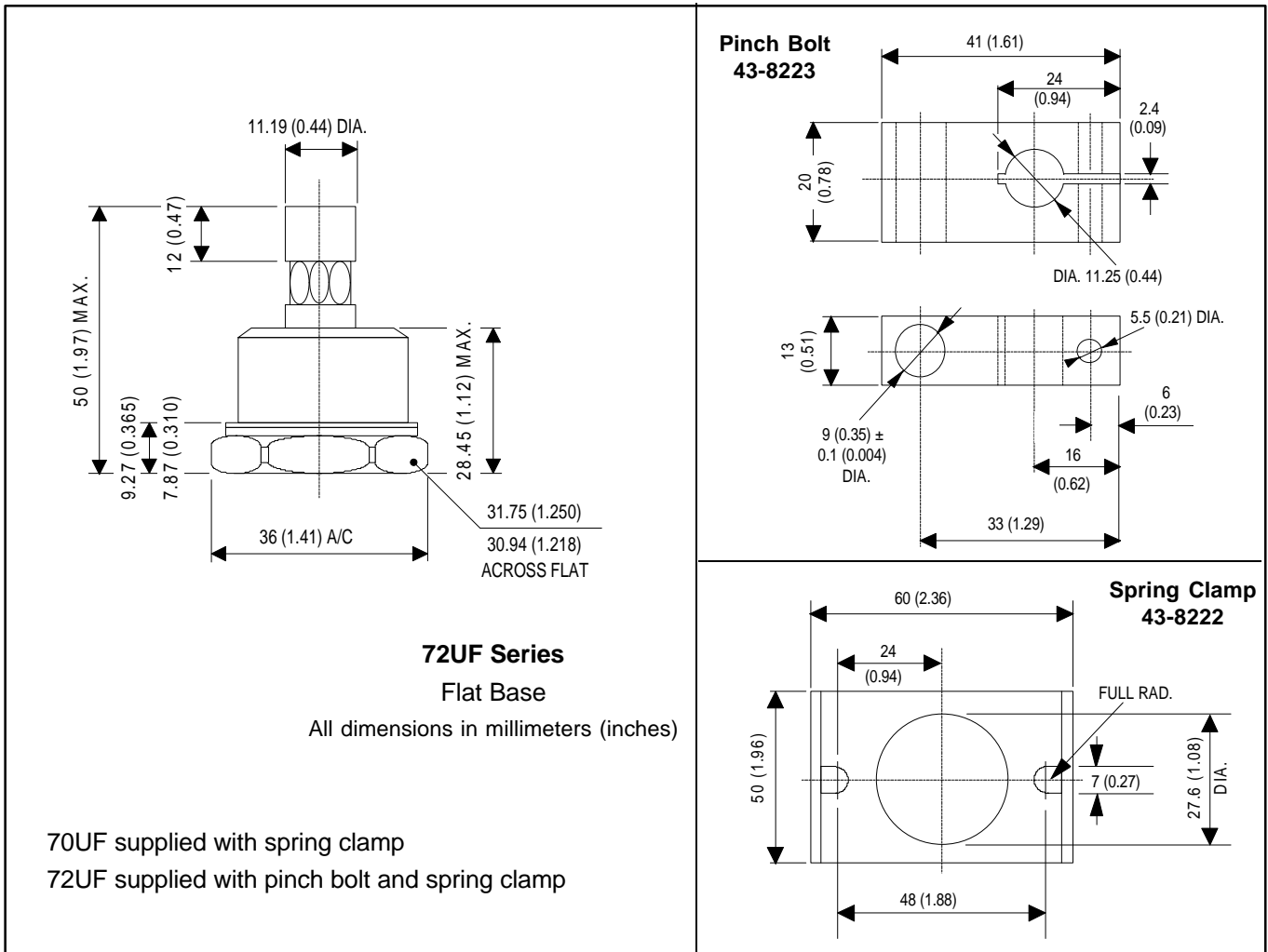

Fig. 1 - Current Ratings Characteristics

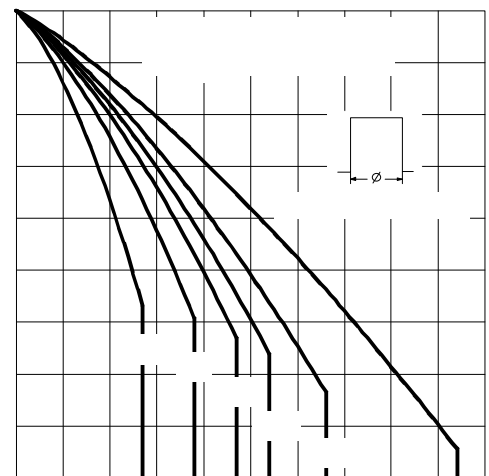

Fig. 2 - Current Ratings Characteristics