

2SC3353, 2SC3353A

Silicon NPN Triple-Diffused Junction Mesa Type

High Breakdown Voltage, High Speed Switching

■ Features

- High speed switching
- High collector-base voltage (V_{CB0})
- Low collector-emitter saturation voltage ($V_{CE(sat)}$)
- "Full Pack" package for simplified mounting on a heat sink with one screw

■ Absolute Maximum Ratings ($T_c=25^\circ\text{C}$)

Item	Symbol	Value	Unit
Collector-base voltage	2SC3353	800	V
	2SC3353A	900	
Collector-emitter voltage	V_{CEO}	500	V
Emitter-base voltage	V_{EBO}	8	V
Peak collector current	I_{CP}	10	A
Collector current	I_C	5	A
Base current	I_B	3	A
Collector power dissipation	$T_c=25^\circ\text{C}$	40	W
	$T_a=25^\circ\text{C}$	2	
Junction temperature	T_j	150	$^\circ\text{C}$
Storage temperature	T_{stg}	-55 ~ +150	$^\circ\text{C}$

■ Package Dimensions

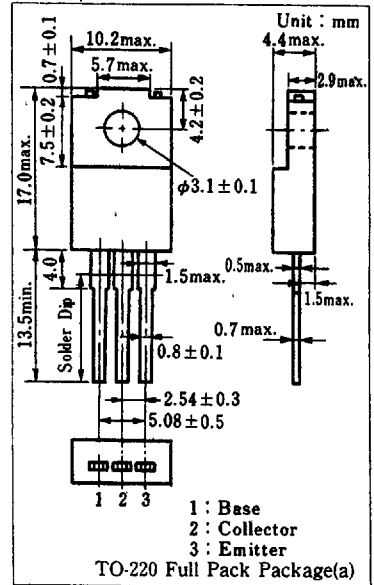

■ Electrical Characteristics ($T_c=25^\circ\text{C}$)

Item	Symbol	Condition	min.	typ.	max.	Unit
Collector cutoff current	2SC3353	$V_{CB}=800\text{ V}, I_E=0$			100	μA
	2SC3353A	$V_{CB}=900\text{ V}, I_E=0$			100	
Emitter cutoff current	I_{EBO}	$V_{EB}=5\text{ V}, I_C=0$			100	μA
Collector-emitter voltage	$V_{CEO(sus)}$	$I_C=0.2\text{ A}, L=25\text{ mH}$	500			V
DC current gain	h_{FE1}	$V_{CE}=5\text{ V}, I_C=0.1\text{ A}$	15			
	h_{FE2}	$V_{CE}=5\text{ V}, I_C=3\text{ A}$	8			
Collector-emitter saturation voltage	$V_{CE(sat)}$	$I_C=3\text{ A}, I_B=0.6\text{ A}$			1	V
Base-emitter saturation voltage	$V_{BE(sat)}$	$I_C=3\text{ A}, I_B=0.6\text{ A}$			1.5	V
Transition frequency	f_T	$V_{CE}=10\text{ V}, I_C=0.5\text{ A}, f=1\text{ MHz}$		3		MHz
Turn-on time	2SC3353	$I_C=3\text{ A}$			1	μs
	2SC3353A				1.2	
Storage time	t_{stg}	$I_{B1}=0.6\text{ A}, I_{B2}=-0.6\text{ A}$			3	μs
Fall time	2SC3353	$V_{CC}=200\text{ V}$			1	μs
	2SC3353A				1.2	

* $V_{CEO(sus)}$ Test method 50/60Hz Mercury relay

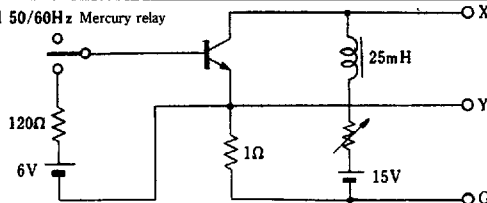

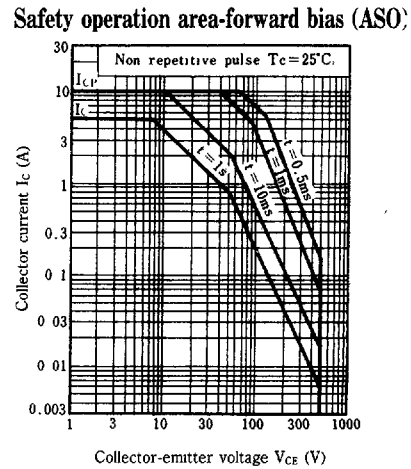
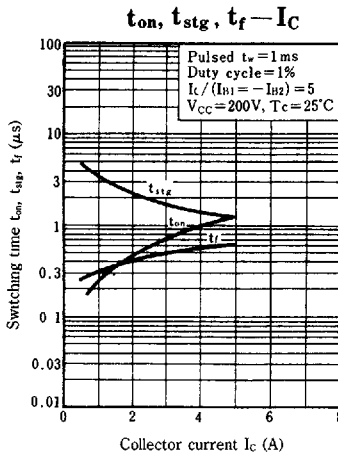
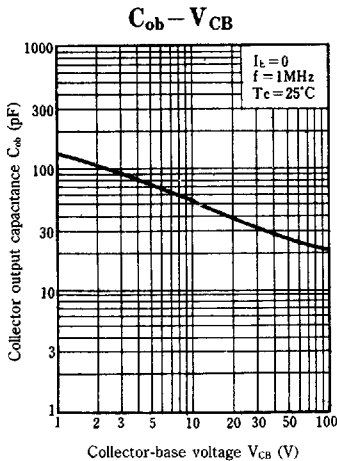
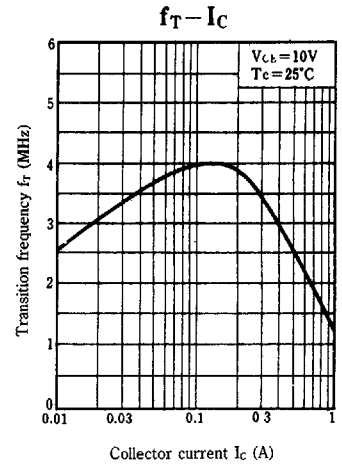
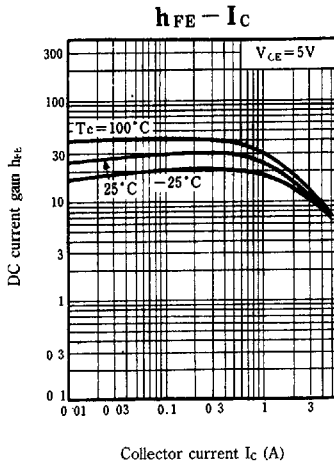
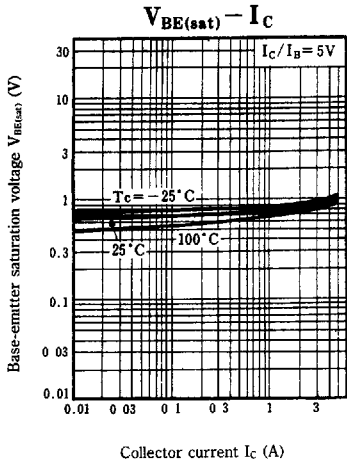
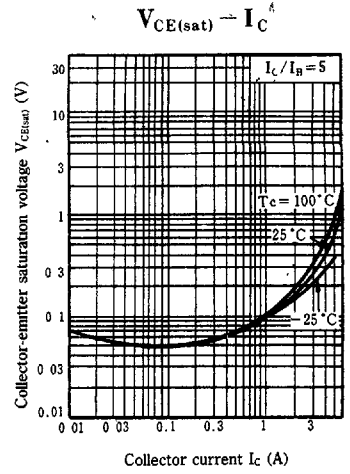
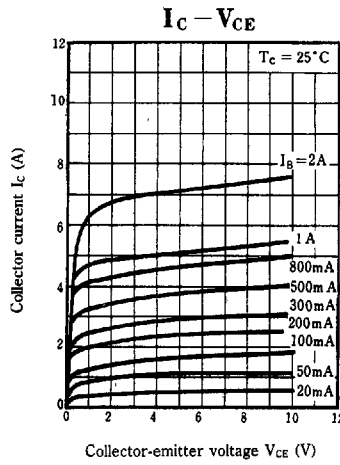
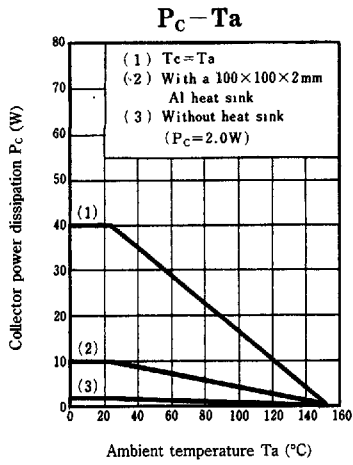

Safety operation area-reverse bias (ASO)

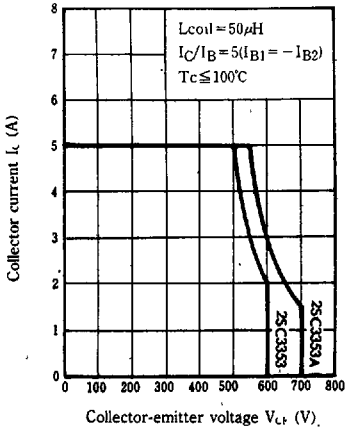

Measurement circuit of reverse bias ASO

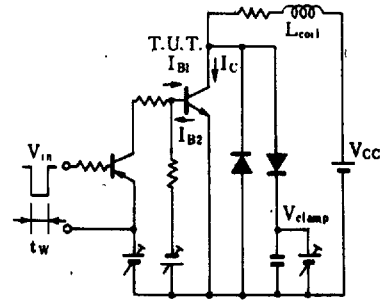

$R_{th(t)} - t$

