

**DISCRIPTION**

2SC3019 is silicon NPN epitaxial planar type transistor designed for RF power amplifiers in UHF band.

**FEATURES**

- High power gain:  $G_{pe} \geq 14\text{dB}$   
@  $P_o = 0.5\text{W}$ ,  $f = 520\text{MHz}$ ,  $V_{CC} = 12.5\text{V}$
- Emitter ballasted construction for high reliability and good performance
- Small-disc-mold type package
- Collector dissipation:  $P_C = 0.6\text{W}$ , (@  $T_a = 25^\circ\text{C}$ )
- Input/Output impedance:  
 $Z_{in} = 2.6 - j3.0\Omega$ ,  $Z_{out} = 16.5 - j56\Omega$   
@  $f = 520\text{MHz}$ ,  $V_{CC} = 12.5\text{V}$ ,  $P_o = 0.5\text{W}$

**APPLICATION**

Exciter stage in UHF band mobile radio application

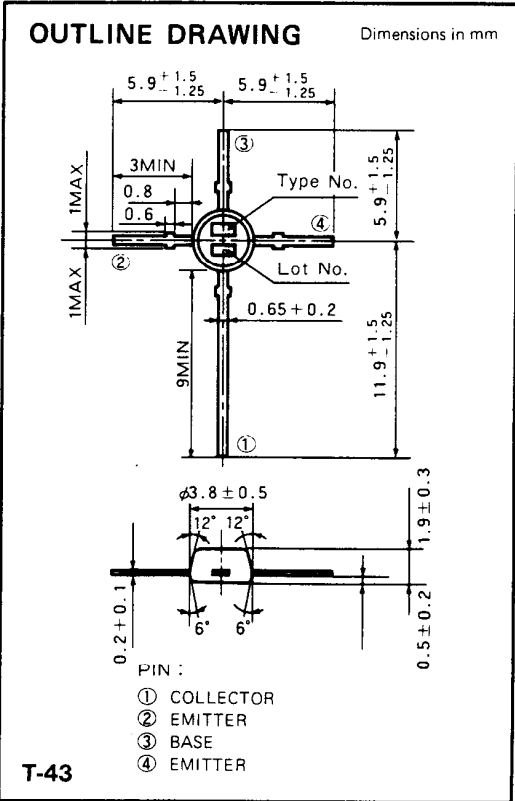

**ABSOLUTE MAXIMUM RATINGS** ( $T_C = 25^\circ\text{C}$  unless otherwise specified)

Symbol	Parameter	Conditions	Ratings	Unit
$V_{CBO}$	Collector to base voltage		35	V
$V_{EBO}$	Emitter to base voltage		4	V
$V_{CEO}$	Collector to emitter voltage	$R_{BE} = \infty$	17	V
$I_C$	Collector current		0.4	A
$P_C$	Collector dissipation	$T_a = 25^\circ\text{C}$	0.6	W
		$T_C = 25^\circ\text{C}$	0.9	W
$T_j$	Junction temperature		135	$^\circ\text{C}$
$T_{stg}$	Storage temperature		-55 to 135	$^\circ\text{C}$
$R_{th-a}$	Thermal resistance	Junction to ambient	250	$^\circ\text{C/W}$
$R_{th-c}$		Junction to case	166	$^\circ\text{C/W}$

Note. Above parameters are guaranteed independently.

**ELECTRICAL CHARACTERISTICS** ( $T_C = 25^\circ\text{C}$  unless otherwise specified)

Symbol	Parameter	Test conditions	Limits			Unit
			Min	Typ	Max	
$V_{(BR)EBO}$	Emitter to base breakdown voltage	$I_E = 1\text{mA}$ , $I_C = 0$	4.0			V
$V_{(BR)CBO}$	Collector to base breakdown voltage	$I_C = 1\text{mA}$ , $I_E = 0$	35			V
$V_{(BR)CEO}$	Collector to emitter breakdown voltage	$I_C = 10\text{mA}$ , $R_{BE} = \infty$	17			V
$I_{CBO}$	Collector cutoff current	$V_{CB} = 15\text{V}$ , $I_E = 0$			500	$\mu\text{A}$
$I_{EBO}$	Emitter cutoff current	$V_{EB} = 3\text{V}$ , $I_C = 0$			500	$\mu\text{A}$
$h_{FE}$	DC forward current gain*	$V_{CE} = 10\text{V}$ , $I_C = 50\text{mA}$	20	70	180	—
$P_o$	Output power	$V_{CC} = 12.5\text{V}$ , $f = 520\text{MHz}$ , $P_{in} = 20\text{mW}$	500	600		mW
$\eta_C$	Collector efficiency		40	50		%

Note. \* Pulse test,  $P_W = 150\mu\text{s}$ , duty = 5%.

Above parameters, ratings, limits and conditions are subject to change.

**NPN EPITAXIAL PLANAR TYPE**

**TEST CIRCUIT**

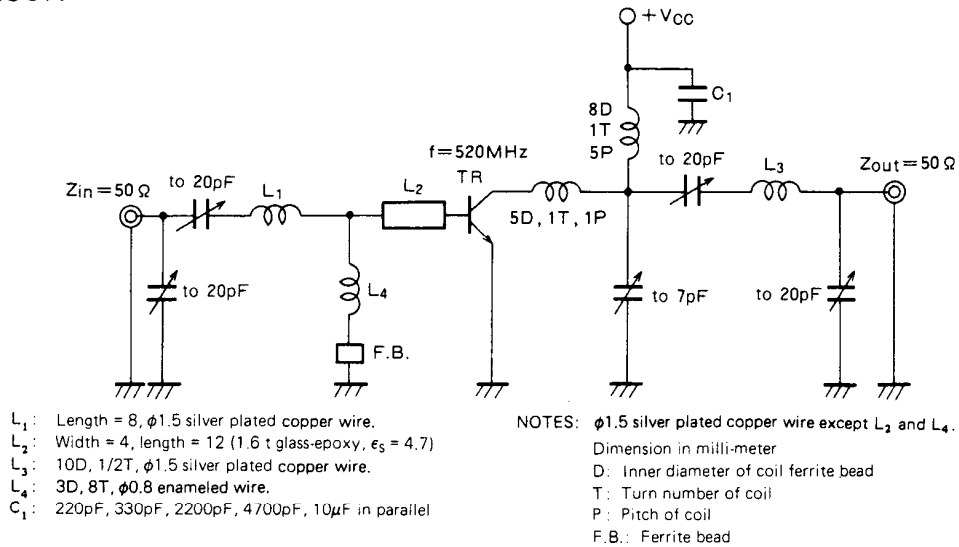

**TYPICAL PERFORMANCE DATE**

**COLLECTOR DISSIPATION VS. AMBIENT TEMPERATURE**

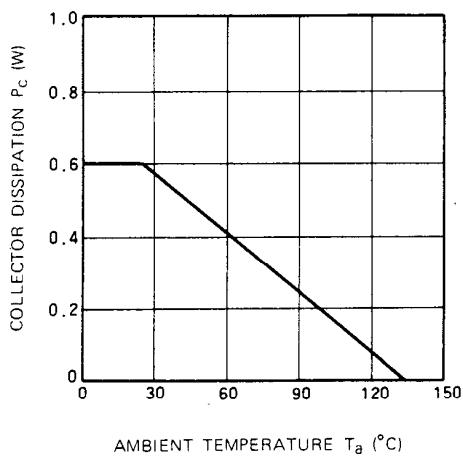

**DC CURRENT GAIN VS. COLLECTOR CURRENT**

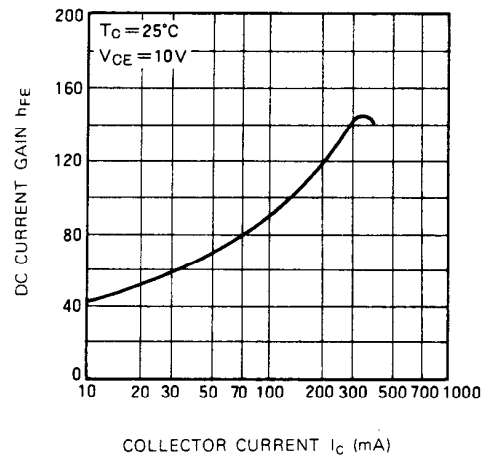

**COLLECTOR OUTPUT CAPACITANCE VS. COLLECTOR TO BASE VOLTAGE**

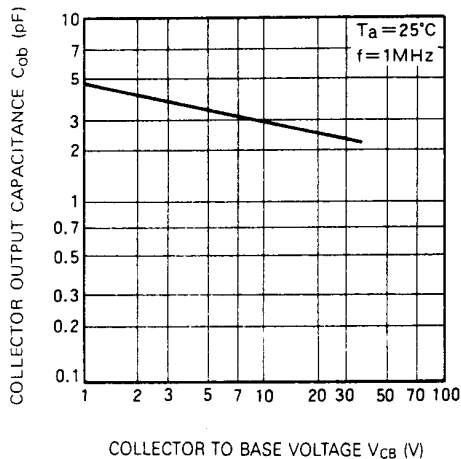

**OUTPUT POWER, COLLECTOR EFFICIENCY VS. INPUT POWER**

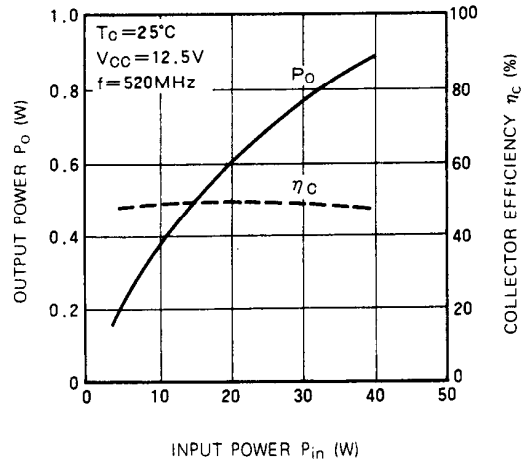

**OUTPUT POWER VS. COLLECTOR SUPPLY VOLTAGE CHARACTERISTICS**

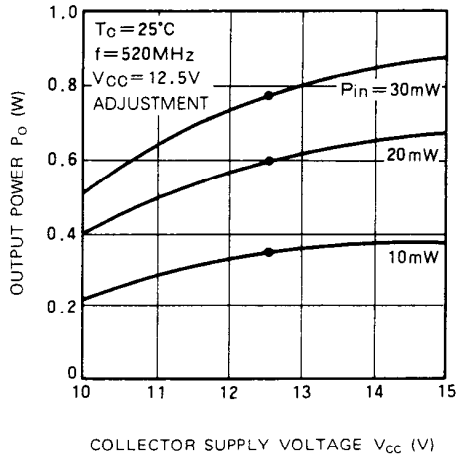

**INPUT/OUTPUT IMPEDANCE**

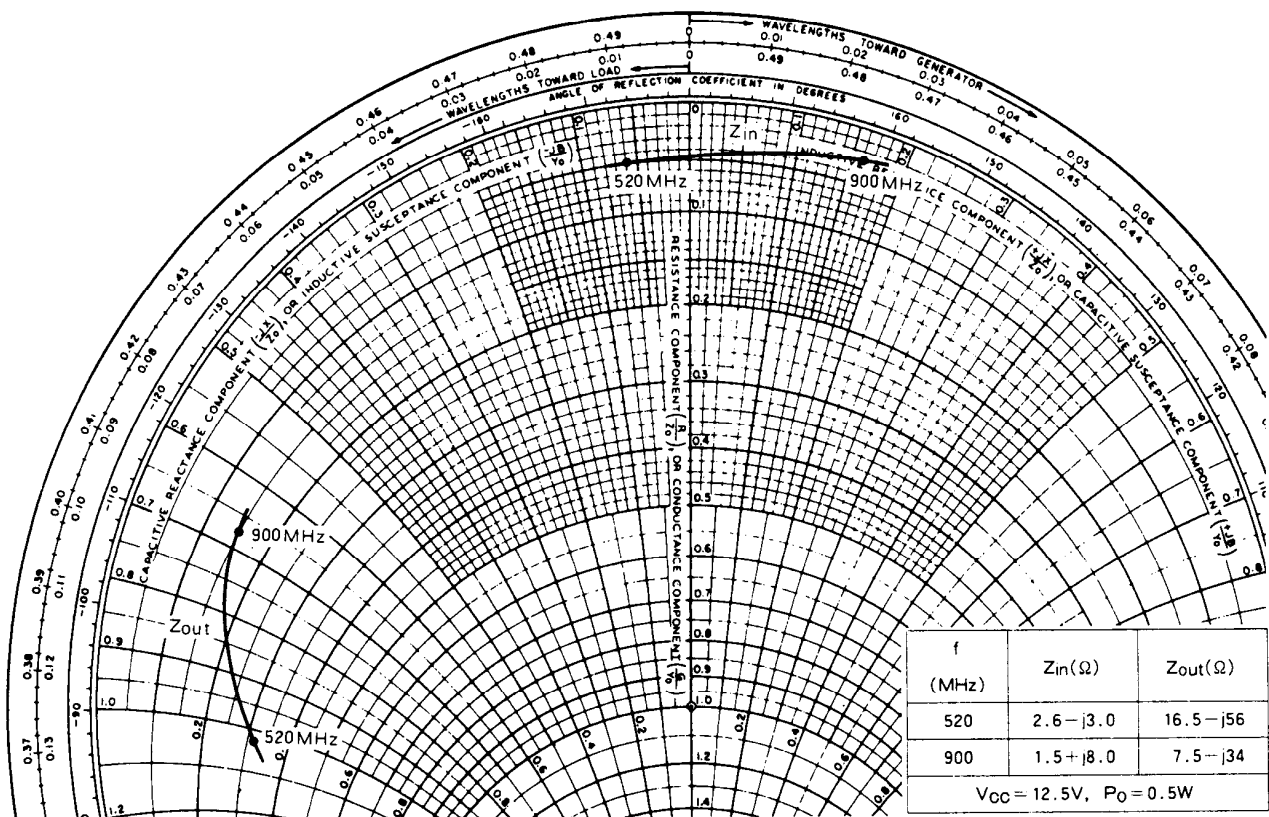

**NPN EPITAXIAL PLANAR TYPE**

**REFERENCE DATA (f = 900MHz)**

**OUTPUT POWER, COLLECTOR EFFICIENCY VS. INPUT POWER**

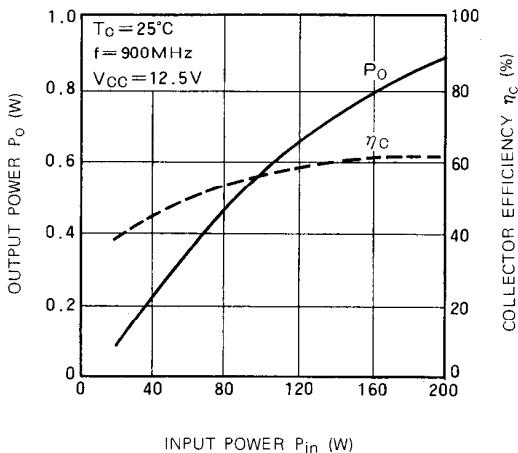

**OUTPUT POWER VS. COLLECTOR SUPPLY VOLTAGE**

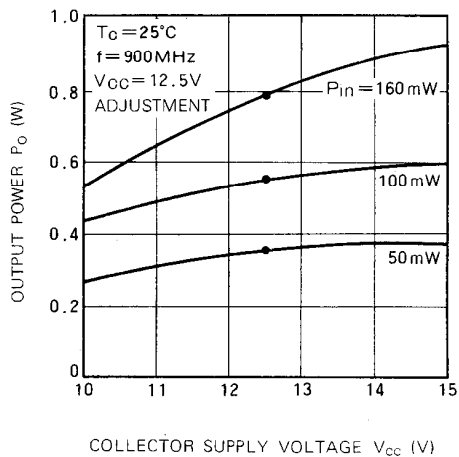

**TEST CIRCUIT**

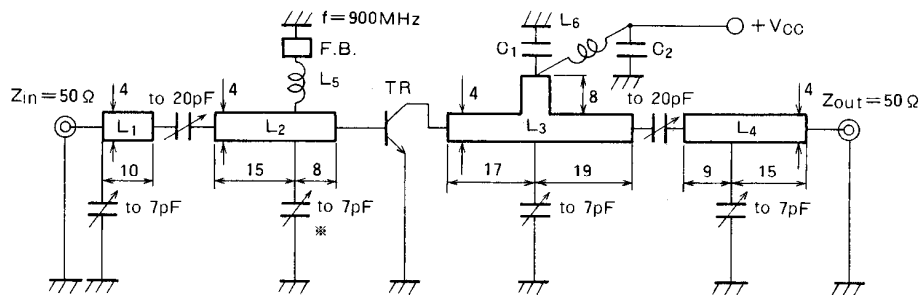

- L<sub>1</sub> to L<sub>4</sub>: Strip-line: 1.6 t glass-teflon  $\epsilon_r = 2.7$
  - L<sub>5</sub>: 4D, 6T, AWG #20 enameled wire ( $\phi 0.8\text{ mm}$ )
  - L<sub>6</sub>: 4D, 5T, AWG #20 enameled wire ( $\phi 0.8\text{ mm}$ )
  - F.B.: Ferrite bead
  - C<sub>1</sub>: 1000pF in parallel
  - C<sub>2</sub>: 100pF, 56pF, 560pF, 4.7 $\mu$ F in parallel
- Unit: mm

**MATCHING PATTERN**

