

9097250 TOSHIBA (DISCRETE/OPTO)

56L 07448 D7-33-13

SILICON NPN TRIPLE DIFFUSED TYPE

2SC1576

REGULATOR APPLICATIONS.
HIGH VOLTAGE SWITCHING APPLICATIONS.

FEATURES:

- High Voltage : $V_{CBO}=450V$
- Low Saturation Voltage :
: $V_{CE(sat)}=1.5V$ (Max.) ($I_C=5A$, $I_B=0.8A$)
- High Speed Switching Time : $t_{stg}=3.0\mu s$ (Typ.)

MAXIMUM RATINGS ($T_a=25^\circ C$)

CHARACTERISTIC	SYMBOL	RATING	UNIT
Collector-Base Voltage	V_{CBO}	450	V
Collector-Emitter Voltage	V_{CEO}	330	V
Emitter-Base Voltage	V_{EBO}	6	V
Collector Current	I_C	8	A
Base Current	I_B	2	A
Collector Power Dissipation ($T_c=25^\circ C$)	P_C	100	W
Junction Temperature	T_j	150	$^\circ C$
Storage Temperature Range	T_{stg}	$-65\sim 150$	$^\circ C$

INDUSTRIAL APPLICATIONS

Unit in mm

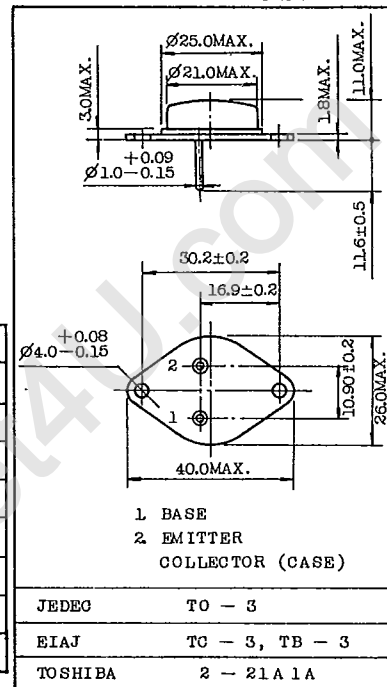

Mounting Kit No. AC73
Weight : 12.9g

ELECTRICAL CHARACTERISTICS ($T_a=25^\circ C$)

CHARACTERISTIC	SYMBOL	TEST CONDITION	MIN.	TYP.	MAX.	UNIT
Collector Cut-off Current	I_{CBO}	$V_{CB}=450V$, $I_E=0$	-	-	100	μA
Emitter Cut-off Current	I_{EBO}	$V_{EB}=6V$, $I_C=0$	-	-	1	mA
Collector-Emitter Breakdown Voltage	$V_{(BR)CEO}$	$I_C=5mA$, $I_B=0$	330	-	-	V
DC Current Gain	h_{FE}	$V_{CE}=5V$, $I_C=1A$	30	-	150	
Collector-Emitter Saturation Voltage	$V_{CE(sat)}$	$I_C=5A$, $I_B=0.8A$	-	-	1.5	V
Base-Emitter Saturation Voltage	$V_{BE(sat)}$	$I_C=5A$, $I_B=0.8A$	-	-	1.8	V
Switching Time	Turn-on Time	t_{on}	-	1.0	-	μs
	Storage Time	t_{stg}	-	3.0	-	
	Fall Time	t_f	-	0.8	-	

$I_{B1} = -I_{B2} = 0.3A$
 DUTY CYCLE $\leq 2\%$

TOSHIBA CORPORATION

9097250 TOSHIBA (DISCRETE/OPTO)

56C 07449

DT-33-13

2SC1576

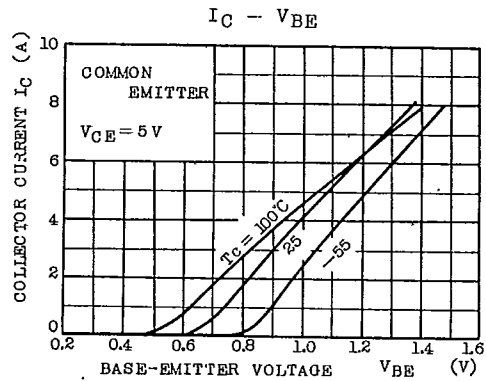
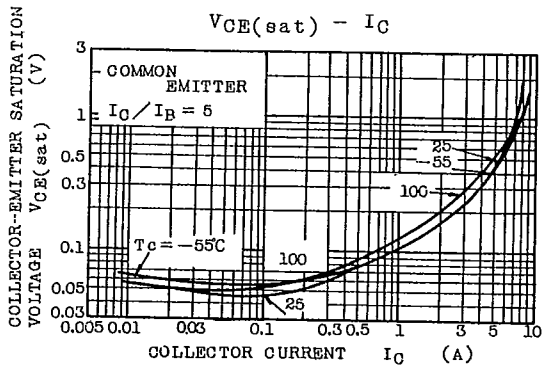
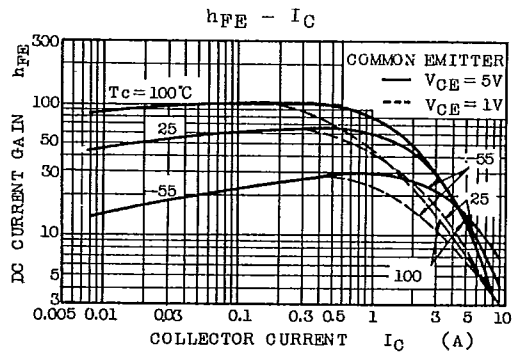
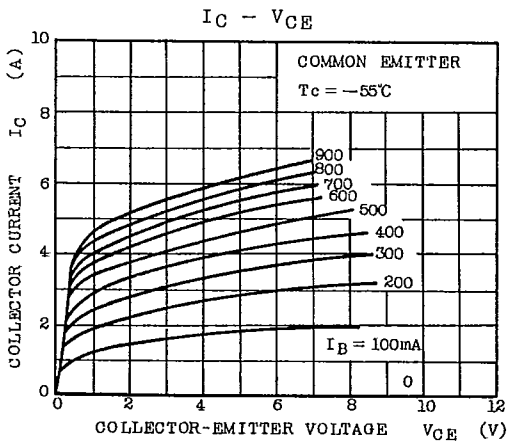
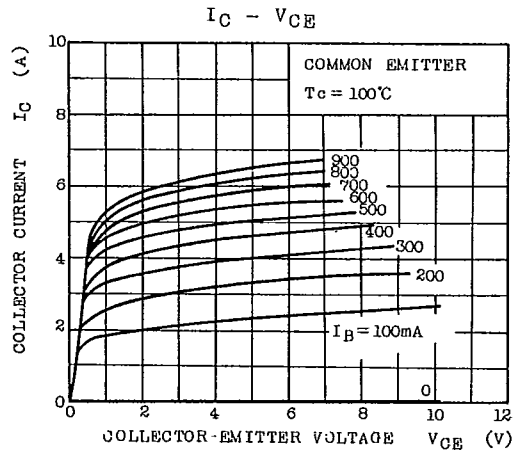
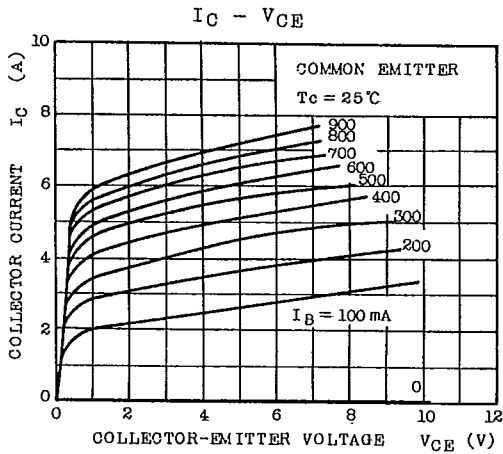

TOSHIBA CORPORATION

2SC1576

