

2N4918 - 2N4920* Series

Preferred Device

Medium-Power Plastic PNP Silicon Transistors

These medium-power, high-performance plastic devices are designed for driver circuits, switching, and amplifier applications.

Features

- Pb-Free Package is Available**
- Low Saturation Voltage – $V_{CE(sat)} = 0.6 \text{ Vdc (Max) @ } I_C = 1.0 \text{ A}$
- Excellent Power Dissipation Due to Thermopad Construction, $P_D = 30 \text{ W @ } T_C = 25^\circ\text{C}$
- Excellent Safe Operating Area
- Gain Specified to $I_C = 1.0 \text{ A}$
- Complement to NPN 2N4921, 2N4922, 2N4923

MAXIMUM RATINGS

Rating	Symbol	Value	Unit
Collector – Emitter Voltage 2N4918 2N4919 2N4920	V_{CEO}	40 60 80	Vdc
Collector – Base Voltage 2N4918 2N4919 2N4920	V_{CBO}	40 60 80	Vdc
Emitter – Base Voltage	V_{EBO}	5.0	Vdc
Collector Current – Continuous (Note 1)	I_C (Note 2)	1.0 3.0	Adc
Base Current	I_B	1.0	Adc
Total Power Dissipation @ $T_A = 25^\circ\text{C}$ Derate above 25°C	P_D	30 0.24	W W/ $^\circ\text{C}$
Operating and Storage Junction Temperature Range	T_J, T_{stg}	-65 to +150	$^\circ\text{C}$

Maximum ratings are those values beyond which device damage can occur. Maximum ratings applied to the device are individual stress limit values (not normal operating conditions) and are not valid simultaneously. If these limits are exceeded, device functional operation is not implied, damage may occur and reliability may be affected.

1. The 1.0 A max I_C value is based upon JEDEC current gain requirements. The 3.0 A max value is based upon actual current-handling capability of the device (See Figure 5).
2. Indicates JEDEC Registered Data for 2N4918 Series.

THERMAL CHARACTERISTICS (Note 3)

Characteristic	Symbol	Max	Unit
Thermal Resistance, Junction-to-Case	θ_{JC}	4.16	$^\circ\text{C/W}$

3. Recommend use of thermal compound for lowest thermal resistance.

**For additional information on our Pb-Free strategy and soldering details, please download the ON Semiconductor Soldering and Mounting Techniques Reference Manual, SOLDERRM/D.



ON Semiconductor®

<http://onsemi.com>

**3.0 A, 40–80 V, 30 W
GENERAL PURPOSE
POWER TRANSISTORS**

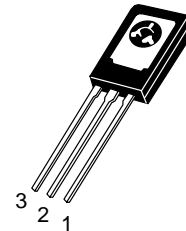

TO-225
CASE 077
STYLE 1

MARKING DIAGRAM

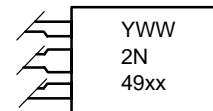

xx = 18, 19, 20
Y = Year
WW = Work Week

ORDERING INFORMATION

See detailed ordering and shipping information in the package dimensions section on page 2 of this data sheet.

*Preferred devices are recommended choices for future use and best overall value.

2N4918 – 2N4920* Series

ELECTRICAL CHARACTERISTICS ($T_C = 25^\circ\text{C}$ unless otherwise noted)

Characteristic		Symbol	Min	Max	Unit
OFF CHARACTERISTICS					
Collector–Emitter Sustaining Voltage (Note 4) ($I_C = 0.1\text{ Adc}$, $I_B = 0$)	2N4918 2N4919 2N4920	$V_{CEO(sus)}$	40 60 80	– – –	Vdc
Collector Cutoff Current ($V_{CE} = 20\text{ Vdc}$, $I_B = 0$) ($V_{CE} = 30\text{ Vdc}$, $I_B = 0$) ($V_{CE} = 40\text{ Vdc}$, $I_B = 0$)	2N4918 2N4919 2N4920	I_{CEO}	– – –	0.5 0.5 0.5	mAdc
Collector Cutoff Current ($V_{CE} = \text{Rated } V_{CEO}$, $V_{BE(off)} = 1.5\text{ Vdc}$) ($V_{CE} = \text{Rated } V_{CEO}$, $V_{BE(off)} = 1.5\text{ Vdc}$, $T_C = 125^\circ\text{C}$)		I_{CEX}	– –	0.1 0.5	mAdc
Collector Cutoff Current ($V_{CB} = \text{Rated } V_{CB}$, $I_E = 0$)		I_{CBO}	–	0.1	mAdc
Emitter Cutoff Current ($V_{BE} = 5.0\text{ Vdc}$, $I_C = 0$)		I_{EBO}	–	1.0	mAdc

ON CHARACTERISTICS

DC Current Gain (Note 4) ($I_C = 50\text{ mAdc}$, $V_{CE} = 1.0\text{ Vdc}$) ($I_C = 500\text{ mAdc}$, $V_{CE} = 1.0\text{ Vdc}$) ($I_C = 1.0\text{ Adc}$, $V_{CE} = 1.0\text{ Vdc}$)		h_{FE}	40 30 10	– 150 –	–
Collector–Emitter Saturation Voltage (Note 4) ($I_C = 1.0\text{ Adc}$, $I_B = 0.1\text{ Adc}$)		$V_{CE(sat)}$	–	0.6	Vdc
Base–Emitter Saturation Voltage (Note 4) ($I_C = 1.0\text{ Adc}$, $I_B = 0.1\text{ Adc}$)		$V_{BE(sat)}$	–	1.3	Vdc
Base–Emitter On Voltage (Note 4) ($I_C = 1.0\text{ Adc}$, $V_{CE} = 1.0\text{ Vdc}$)		$V_{BE(on)}$	–	1.3	Vdc

SMALL–SIGNAL CHARACTERISTICS

Current–Gain – Bandwidth Product ($I_C = 250\text{ mAdc}$, $V_{CE} = 10\text{ Vdc}$, $f = 1.0\text{ MHz}$)		f_T	3.0	–	MHz
Output Capacitance ($V_{CB} = 10\text{ Vdc}$, $I_E = 0$, $f = 100\text{ kHz}$)		C_{ob}	–	100	pF
Small–Signal Current Gain ($I_C = 250\text{ mAdc}$, $V_{CE} = 10\text{ Vdc}$, $f = 1.0\text{ kHz}$)		h_{fe}	25	–	–

4. Pulse Test: $PW \approx 300\ \mu\text{s}$, Duty Cycle $\approx 2.0\%$

ORDERING INFORMATION

Device	Package	Shipping†
2N4918	TO–225	500 Unit / Bulk
2N4919	TO–225	500 Unit / Bulk
2N4920	TO–225	500 Unit / Bulk
2N4920G	TO–225 (Pb–Free)	500 Unit / Bulk

†For information on tape and reel specifications, including part orientation and tape sizes, please refer to our Tape and Reel Packaging Specifications Brochure, BRD8011/D.

2N4918 – 2N4920* Series

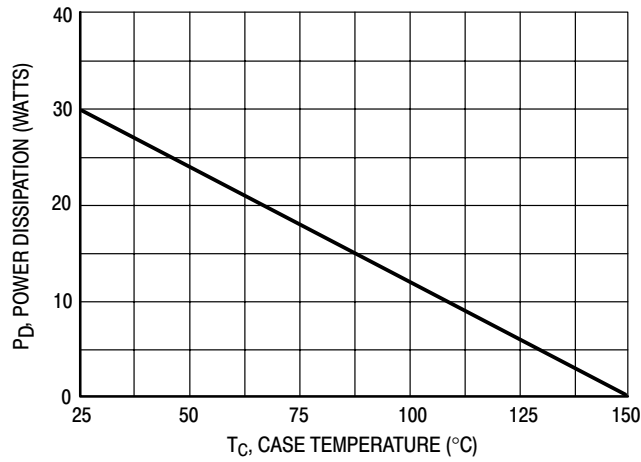

Figure 1. Power Derating

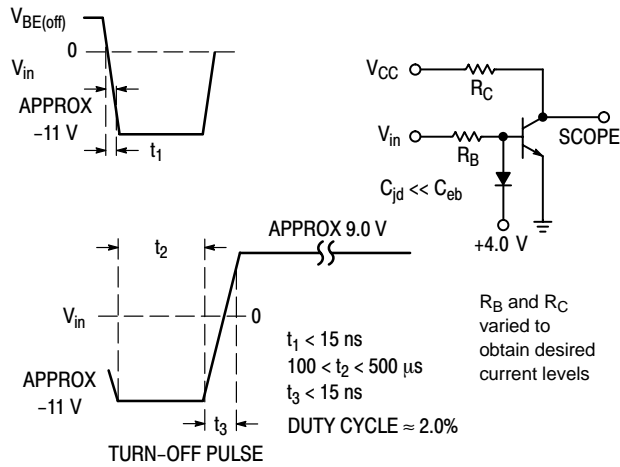

Figure 2. Switching Time Equivalent Test Circuit

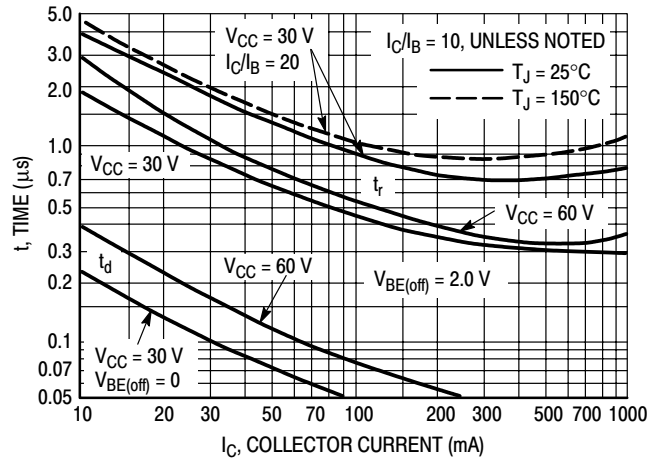

Figure 3. Turn-On Time

2N4918 – 2N4920* Series

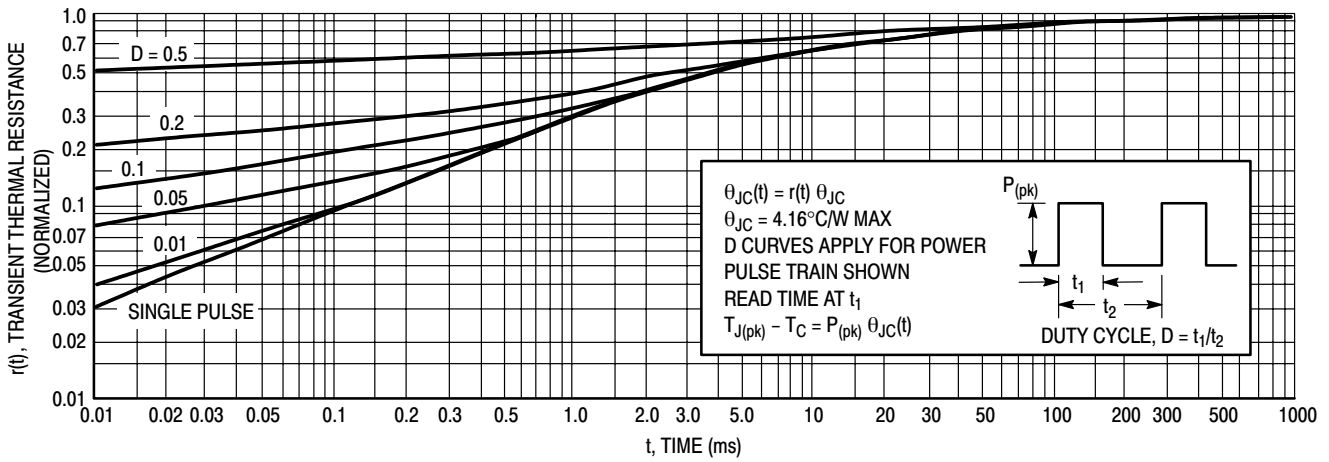

Figure 4. Thermal Response

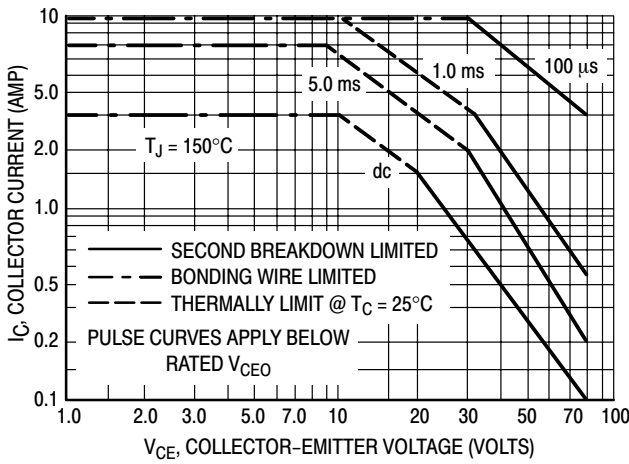

Figure 5. Active-Region Safe Operating Area

There are two limitations on the power handling ability of a transistor: average junction temperature and second breakdown. Safe operating area curves indicate $I_C - V_{CE}$ operation i.e., the transistor must not be subjected to greater dissipation than the curves indicate.

The data of Figure 5 is based on $T_{J(pk)} = 150^{\circ}\text{C}$; T_C is variable depending on conditions. Second breakdown pulse limits are valid for duty cycles to 10% provided $T_{J(pk)} \leq 150^{\circ}\text{C}$. At high case temperatures, thermal limitations will reduce the power that can be handled to values less than the limitations imposed by second breakdown.

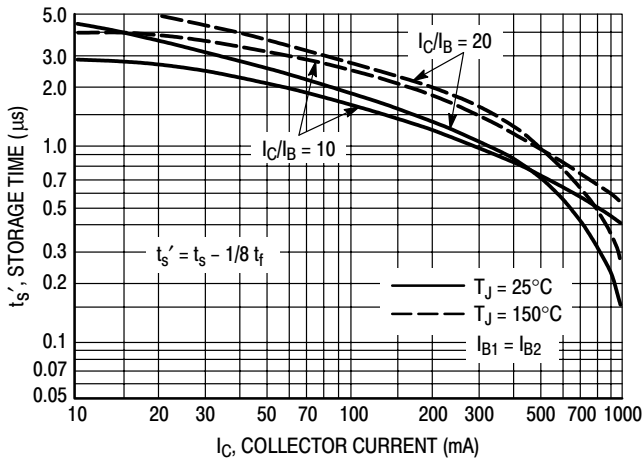

Figure 6. Storage Time

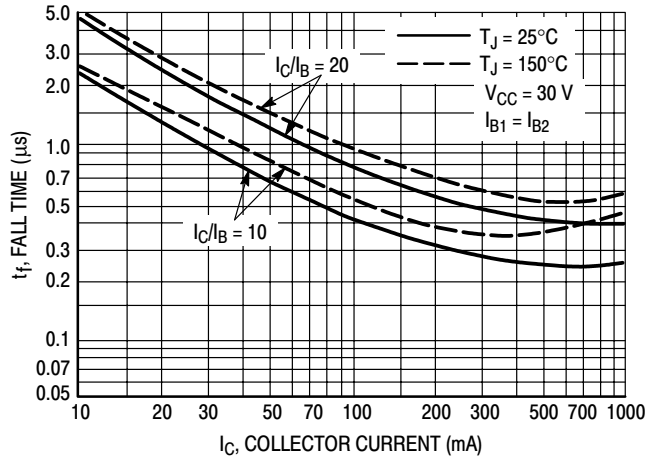

Figure 7. Fall Time

2N4918 – 2N4920* Series

TYPICAL DC CHARACTERISTICS

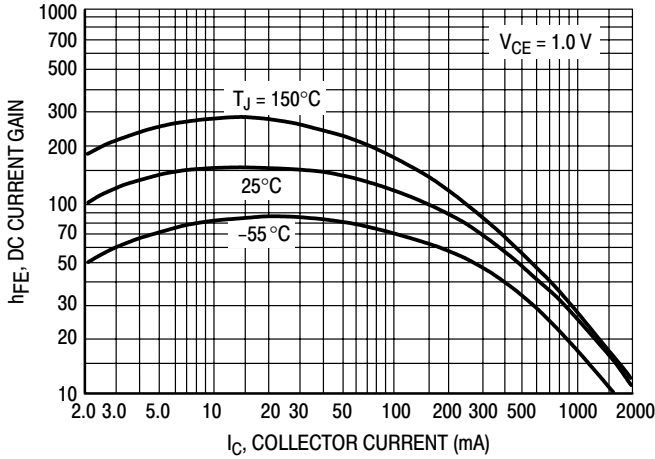

Figure 8. Current Gain

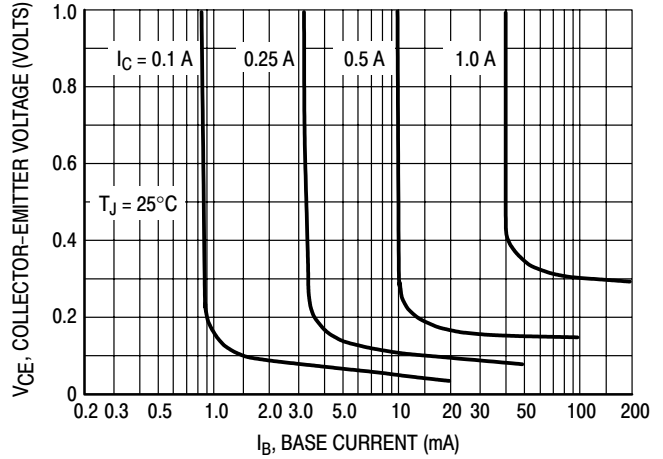

Figure 9. Collector Saturation Region

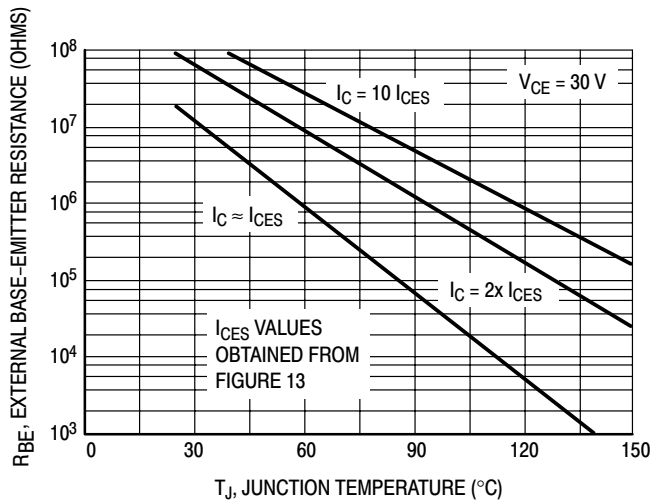

Figure 10. Effects of Base-Emitter Resistance

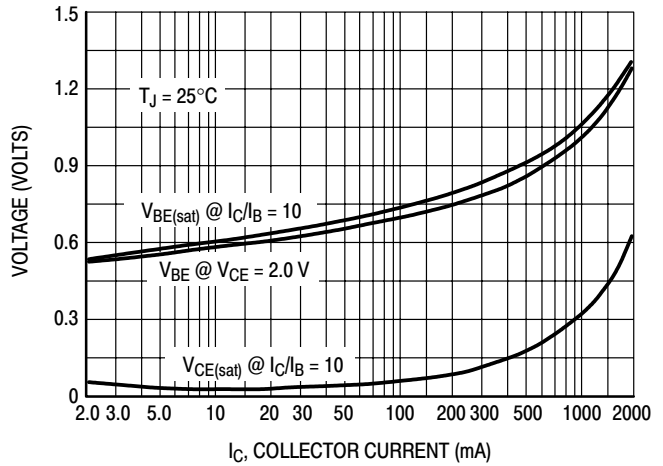

Figure 11. "On" Voltage

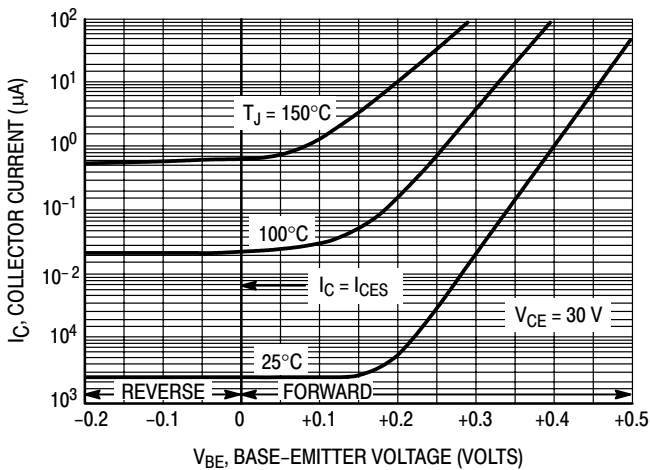

Figure 12. Collector Cut-Off Region

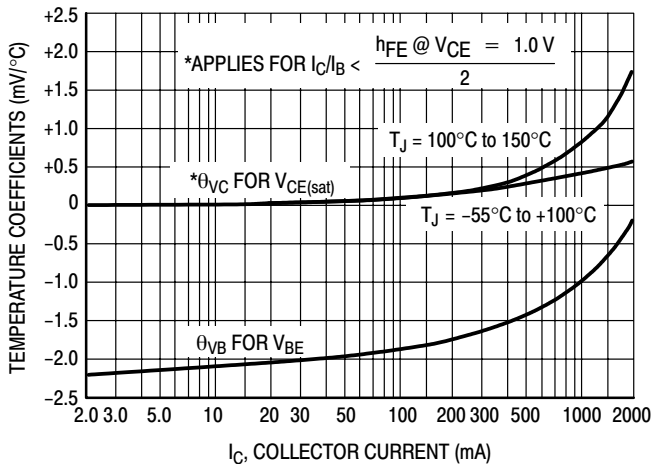
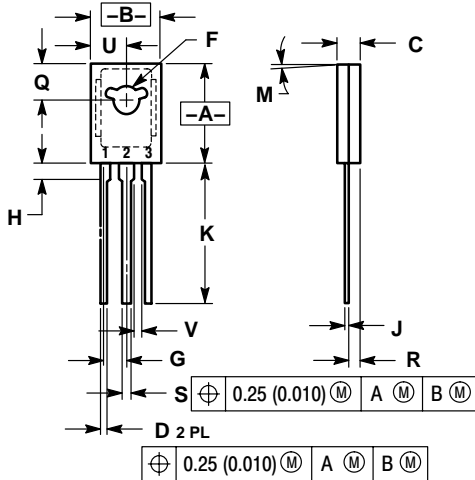

Figure 13. Temperature Coefficients

2N4918 – 2N4920* Series

PACKAGE DIMENSIONS

TO-225
CASE 77-09
ISSUE Z



NOTES:

1. DIMENSIONING AND TOLERANCING PER ANSI Y14.5M, 1982.
2. CONTROLLING DIMENSION: INCH.
3. 077-01 THRU -08 OBSOLETE, NEW STANDARD 077-09.

DIM	INCHES		MILLIMETERS	
	MIN	MAX	MIN	MAX
A	0.425	0.435	10.80	11.04
B	0.295	0.305	7.50	7.74
C	0.095	0.105	2.42	2.66
D	0.020	0.026	0.51	0.66
F	0.115	0.130	2.93	3.30
G	0.094 BSC		2.39 BSC	
H	0.050	0.095	1.27	2.41
J	0.015	0.025	0.39	0.63
K	0.575	0.655	14.61	16.63
M	5° TYP		5° TYP	
Q	0.148	0.158	3.76	4.01
R	0.045	0.065	1.15	1.65
S	0.025	0.035	0.64	0.88
U	0.145	0.155	3.69	3.93
V	0.040	---	1.02	---

STYLE 1:

- PIN 1. EMITTER
- COLLECTOR
- BASE

ON Semiconductor and are registered trademarks of Semiconductor Components Industries, LLC (SCILLC). SCILLC reserves the right to make changes without further notice to any products herein. SCILLC makes no warranty, representation or guarantee regarding the suitability of its products for any particular purpose, nor does SCILLC assume any liability arising out of the application or use of any product or circuit, and specifically disclaims any and all liability, including without limitation special, consequential or incidental damages. "Typical" parameters which may be provided in SCILLC data sheets and/or specifications can and do vary in different applications and actual performance may vary over time. All operating parameters, including "Typicals" must be validated for each customer application by customer's technical experts. SCILLC does not convey any license under its patent rights nor the rights of others. SCILLC products are not designed, intended, or authorized for use as components in systems intended for surgical implant into the body, or other applications intended to support or sustain life, or for any other application in which the failure of the SCILLC product could create a situation where personal injury or death may occur. Should Buyer purchase or use SCILLC products for any such unintended or unauthorized application, Buyer shall indemnify and hold SCILLC and its officers, employees, subsidiaries, affiliates, and distributors harmless against all claims, costs, damages, and expenses, and reasonable attorney fees arising out of, directly or indirectly, any claim of personal injury or death associated with such unintended or unauthorized use, even if such claim alleges that SCILLC was negligent regarding the design or manufacture of the part. SCILLC is an Equal Opportunity/Affirmative Action Employer. This literature is subject to all applicable copyright laws and is not for resale in any manner.

PUBLICATION ORDERING INFORMATION

LITERATURE FULFILLMENT:

Literature Distribution Center for ON Semiconductor
P.O. Box 61312, Phoenix, Arizona 85082-1312 USA
Phone: 480-829-7710 or 800-344-3860 Toll Free USA/Canada
Fax: 480-829-7709 or 800-344-3867 Toll Free USA/Canada
Email: orderlit@onsemi.com

N. American Technical Support: 800-282-9855 Toll Free
USA/Canada

Japan: ON Semiconductor, Japan Customer Focus Center
2-9-1 Kamimeguro, Meguro-ku, Tokyo, Japan 153-0051
Phone: 81-3-5773-3850

ON Semiconductor Website: <http://onsemi.com>

Order Literature: <http://www.onsemi.com/litorder>

For additional information, please contact your local Sales Representative.