

Technical data sheet

Interface Technology · LCIS analogue/analogue converter

Input: 4–20 mA

Output: 0–20 mA

Insulation: 2.5 kV, 3-way isolation



Identification

Type	LCIS-WAA-1537-62-PI
Part No.	751537.0000

Product version

Hardware revision	1.0
Software version	1.1
Datasheet version	02

Input

Input signal	4–20 mA
Galvanic isolation I/O	3-way isolation
Zero /Span	Production comparison
Input resistance	100 Ω

Output

Output signal	0–20 mA
Output current limit	min. 0 mA for all output ranges with nominal lower limit 0 mA max. 21.6 mA for all output ranges with nominal upper limit 20 mA
Max. load impedance at I-output	500 Ω
Output voltage	<16 V
Residual ripple	<20 mV _{eff}

Operating data

Accuracy	0.1 % FSR @ 23 °C
----------	-------------------

United Kingdom: LÜTZE Ltd.

Unit 3, Sandy Hill Park
Sandy Way, Amington • GB-Tamworth, Staffs B77 4DU
Tel. +44 (0)1827 31333-0 • Fax +44 (0)1827 31333-2
www.lutze.com • sales.gb@lutze.co.uk

Germany: Friedrich Lütze GmbH

Postfach 12 24 (PLZ 71366) • Bruckwiesenstraße 17-19 • D-71384 Weinstadt
Tel. +49 (0)7151 6053-0 • Fax +49 (0)7151 6053-277(-288)
www.luetze.de • info@luetze.de

12.12.2023 • Subject to technical modification
Part No. [751537.0000](#) • Datasheet version: 02

Technical data sheet

Interface Technology · LCIS analogue/analogue converter

Linearity error	0.05 % FSR
Rise time (10-90%)	6 ms
Build-up time (Accuracy 1%)	17 ms
Temperature coefficient	<150 ppm / K FSR
Critical frequency	30 Hz @ 3 dB

General

Rated voltage U_N	AC/DC 24 V
Current Consumption	22 mA
Status indication	LED green
Input/output protection	Overvoltage, current input with PTC fuse, short circuit-proof output
Insulation voltage input / output	2.5 kV _{eff}
Housing material	PA 6.6 (UL 94 V-0, NFF I2, F2)
Color of the housing	RAL 7012 basalt grey
Mounting	DIN rail mountable TS35 (EN 60715)
Degree of protection	IP20
Installation position	Any
Connection type	Push-In single wire 0.25 mm ² – 2.5 mm ² / AWG 24–14 fine stranded wire with ferrule 0.25 mm ² – 1.5 mm ² / AWG 24–16
Strip length	8 mm
Dimensions (w × h × d)	6.2 mm × 93.0 mm × 73.0 mm
Weight/unit	0.029 kg
PU (units)	1

General ambient conditions

Operation temperature range	-25 °C ... +60 °C
Storage temperature range	-40 °C ... +80 °C
Relative air humidity	20 – 90 % RH, not condensing
Vibration resistance	0.7 g acc. to EN 60068-2-6

Failure Rate Prediction (MTBF)

Standards	Electronic components – Reliability – Reference conditions for failure rates and stress models for conversion: EN/IEC 61709 Failure Rates of Components – Expected values: SN 29500
Failure rate at +45 °C	504 fit
Failure rate at +45 °C	1983891 h 1 fit equals one failure per 10 ⁹ component hours
Comments	The indicated temperature is the mean component ambient temperature. The results are valid under following conditions: Automotive environment or industrial areas without extreme dust levels and harmful substances Continuous operation 8760 h per year

Technical data sheet

Interface Technology · LCIS analogue/analogue converter

Certifications/Standards

Conformity	CE UKCA
Certifications	cULus (E135145) DNV (TAA000024Y)
Standards	EN 60947-1 EN 60947-5-1 EN 61000-6-2 EN 61000-6-4 UL 508 DNV-CG-0339

Dimensions

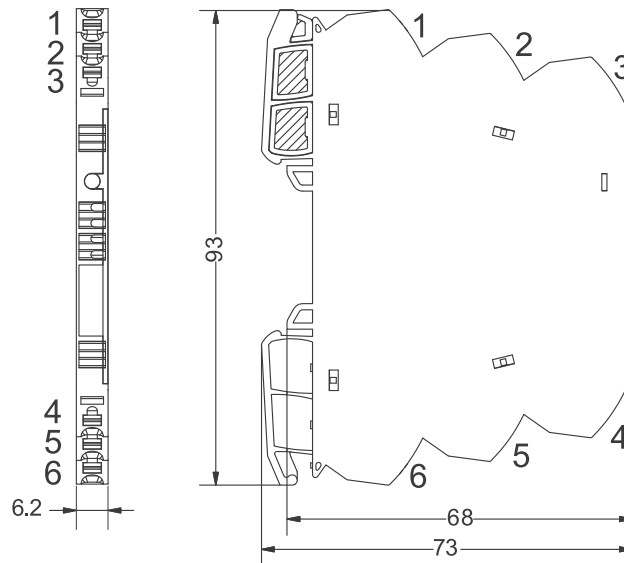

PIN assignment

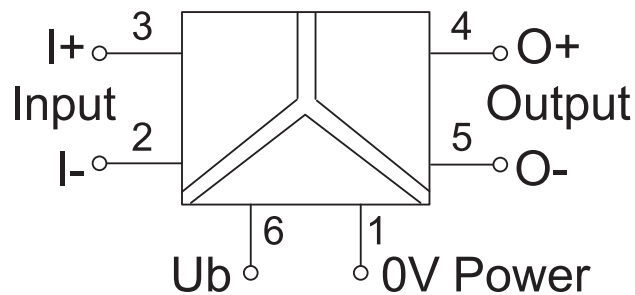

Technical data sheet

Interface Technology · LCIS analogue/analogue converter

Use

