

## Technical data sheet

Interface Technology · LCIS analogue/analogue converter

---

**Input: 0–10 V / 0–20 mA / 4–20 mA, manual off automatic**

**Output: 0–10 V / 0–20 mA / 4–20 mA**

**Insulation: 4 kV, 3-way isolation, Wide range input**



---

### Identification

Type	LCIS-WP-WAA-MA-1519-PI
Part No.	<a href="#">751519.0000</a>

---

### Product version

Hardware revision	1.0
Software version	1.2
Datasheet version	01

---

### Input

Input signal	0–10 V, 0–20 mA, 4–20 mA, adjustable via DIP switch S1
Galvanic isolation I/O	3-way isolation
Zero /Span	Production comparison
Input resistance	>330 k $\Omega$ @ 0–10 V, <100 $\Omega$ @ 0–20 mA, 4–20 mA

---

### Output

Output signal	0–10 V, 0–20 mA, 4–20 mA adjustable via switch
Output voltage limit	min 0 V max 10.8 V for all output ranges with nominal upper limit 10 V
Output current limit	min. 0 mA for all output ranges with nominal lower limit 0 mA min. 3.6 mA or all output ranges 4 – 20 mA max. 21.6 mA for all output ranges with nominal upper limit 20 mA
Max. load impedance at I-output	500 $\Omega$ @ 0–20 mA, 4–20 mA
Min. load impedance at U-output	2 k $\Omega$ @ 0–10 V
Load deviation	at U-output max. 5 mV @ 2 k $\Omega$
Output voltage	<18 V @ 0–20 mA, 4–20 mA

---

#### United Kingdom: LÜTZE Ltd.

Unit 3, Sandy Hill Park  
Sandy Way, Amington • GB-Tamworth, Staffs B77 4DU  
Tel. +44 (0)1827 31333-0 • Fax +44 (0)1827 31333-2  
[www.lutze.com](http://www.lutze.com) • [sales.gb@lutze.co.uk](mailto:sales.gb@lutze.co.uk)

#### Germany: Friedrich Lütze GmbH

Postfach 12 24 (PLZ 71366) • Bruckwiesenstraße 17-19 • D-71384 Weinstadt  
Tel. +49 (0)7151 6053-0 • Fax +49 (0)7151 6053-277(-288)  
[www.luetze.de](http://www.luetze.de) • [info@luetze.de](mailto:info@luetze.de)

## Technical data sheet

### Interface Technology · LCIS analogue/analogue converter

---

Output current	max. 5 mA @ 0–10 V
Residual ripple	<20 mV <sub>eff</sub>

---

#### Operating data

---

Accuracy	0.1 % FSR @ 23 °C
Linearity error	0.05 % FSR
Rise time (10-90%)	6 ms
Build-up time (Accuracy 1%)	17 ms
Temperature coefficient	<150 ppm / K FSR
Critical frequency	30 Hz @ 3 dB

---

#### General

---

Rated voltage U <sub>N</sub>	AC/DC 24–240 V
Current Consumption	19 mA
Status indication	LED green
Input/output protection	Overvoltage, current input with PTC fuse, short circuit-proof output
Insulation voltage input / output	4.0 kV <sub>eff</sub>
Housing material	PA 6.6 (UL 94 V-0, NFF I2, F2)
Color of the housing	RAL 7012 basalt grey
Mounting	DIN rail mountable TS35 (EN 60715)
Degree of protection	IP20
Installation position	Any
Connection type	Push-In single wire 0.25 mm <sup>2</sup> – 2.5 mm <sup>2</sup> / AWG 24–14 fine stranded wire with ferrule 0.25 mm <sup>2</sup> – 1.5 mm <sup>2</sup> / AWG 24–16
Strip length	8 mm
Dimensions (w × h × d)	17.5 mm × 93.0 mm × 75.0 mm
Weight/unit	0.059 kg
PU (units)	1

---

#### General ambient conditions

---

Operation temperature range	-25 °C ... +60 °C
Storage temperature range	-40 °C ... +80 °C
Relative air humidity	20 – 90 % RH, not condensing
Vibration resistance	0.7 g acc. to EN 60068-2-6

---

#### Failure Rate Prediction (MTBF)

---

Standards	Electronic components – Reliability – Reference conditions for failure rates and stress models for conversion: EN/IEC 61709 Failure Rates of Components – Expected values: SN 29500
Failure rate at +45 °C	724 fit
Failure rate at +45 °C	1381278 h

---

## Technical data sheet

### Interface Technology · LCIS analogue/analogue converter

Comments	1 fit equals one failure per $10^9$ component hours
	The indicated temperature is the mean component ambient temperature.
	The results are valid under following conditions: Automotive environment or industrial areas without extreme dust levels and harmful substances
	Continuous operation 8760 h per year

### Certifications/Standards

Conformity	CE UKCA
Certifications	cULus (E135145) DNV (TAA000024Y)
Standards	EN 60947-1 EN 60947-5-1 EN 61000-6-2 EN 61000-6-4 UL 508 DNV-CG-0339

### Dimensions

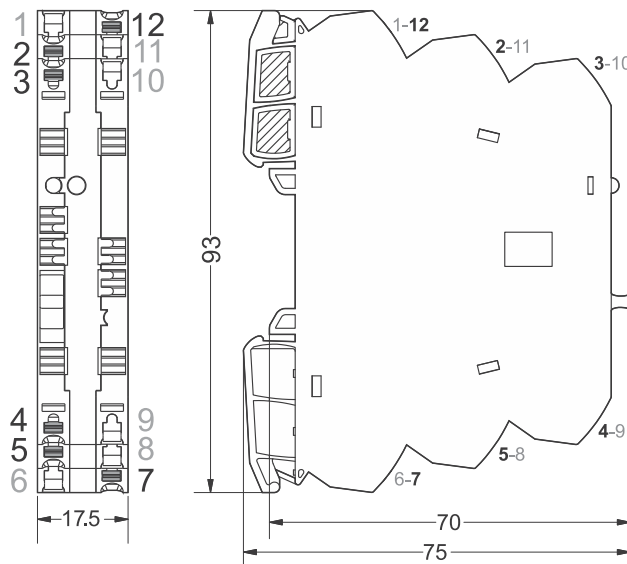

### PIN assignment

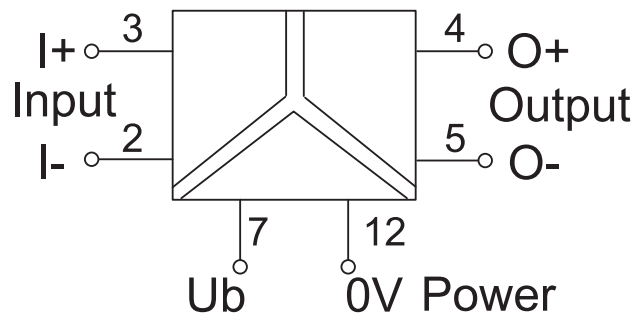

# Technical data sheet

## Interface Technology · LCIS analogue/analogue converter

### Use

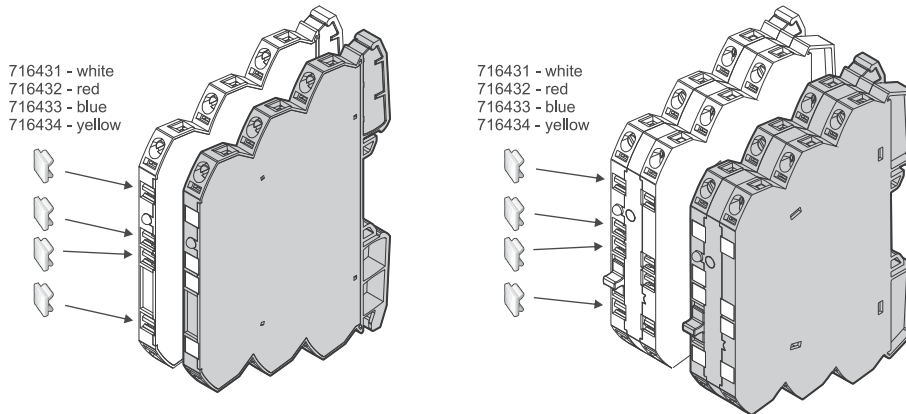

### Use

#### DE DIP-Schalterstellungen EN DIP switch positions FR Positions des interrupteurs DIP

**DE HINWEIS:** Die Schalter dürfen während des Betriebs nicht umgeschaltet werden. Der Wandler benötigt einen Neustart.  
**EN NOTICE:** The switches must not be switched during operation. The converter requires a restart.  
**FR AVIS:** Les interrupteurs ne doivent pas être actionnés pendant le fonctionnement. Le convertisseur nécessite un redémarrage.

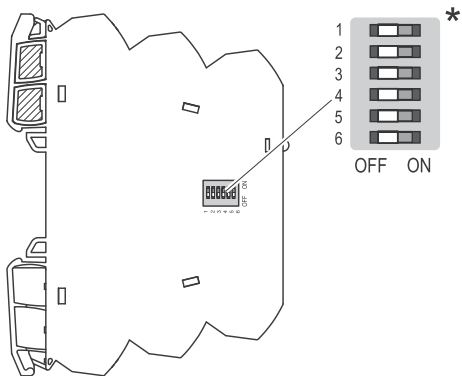

\* DE: Auslieferungszustand (Werkseinstellung): 0-Einstellung/ alle Schalter sind auf OFF gestellt.  
**Je nach Art des Wandlers ist dann bereits ein bestimmter Bereich voreingestellt.**

\* EN: Delivery state (factory setting): 0 setting/ all switches are set to OFF.  
**Depending on the type of transducer, a certain range is then already preset.**

\* FR: État à la livraison (réglage d'usine) : réglage 0/ tous les interrupteurs sont sur OFF.  
**Selon le type de transducteur, une certaine plage est alors déjà prédéfinie.**

750510.0000  
 751510.0000  
 751518.0000  
 751519.0000  
 750518.0000  
 750519.0000

S1	Input	1	2	3	4
●→Switch On					
0- 10V*		●			
0-20mA		●			
4-20mA		●	●		

S1	Output	5	6
●→Switch On			
0- 10V*		●	
0-20mA		●	
4-20mA		●	●

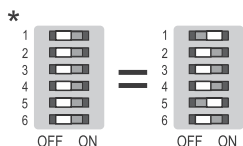

750516.0000  
 750517.0000  
 751516.0000  
 751517.0000

S1	Input	1	2	3	4
●→Switch On					
0- 60 mV		●			
0- 100 mV		●			
0- 300 mV		●			
0- 500 mV		●	●		
0- 1 V		●	●		
0- 2 V		●	●		
0- 5 V		●	●	●	
0- 10 V*		●	●	●	
2- 10 V		●	●	●	●
0- 20 V		●	●	●	●
0- 5 mA		●	●	●	●
0- 10 mA		●	●	●	●
± 5 mA		●	●	●	●
± 20 mA		●	●	●	●
0- 20 mA		●	●	●	●
4- 20 mA		●	●	●	●

S1	Output	5	6
●→Switch On			
0- 10 V*		●	
0- 20 mA		●	
4- 20 mA		●	●

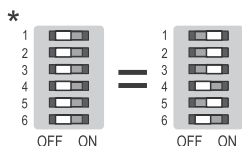

750512.0000  
 751512.0000

S1	Input	1	2	3	4
●→Switch On					
0- 10 V*		●			
0- 20 mA		●			
4- 20 mA		●	●		

S1	Output	5	6
●→Switch On			
0- 50 Hz*		●	
0- 100 Hz		●	
0- 1000 Hz		●	●
0- 10000 Hz		●	●

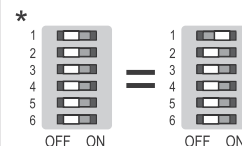

Use

**DE** Schalterstellungen M-0-A **EN** Switch Positions M-0-A **FR** Positions des interrupteurs M-0-A

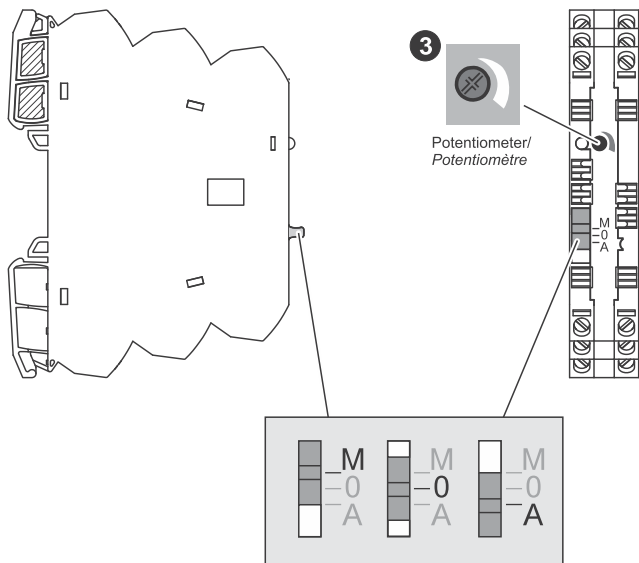

**M - manuell/ manually/ manuellement:**

- DE** Mit dem Potentiometer (3) kann der Ausgangswert eingestellt werden: (0-10V oder 0-20mA oder 4-20mA)
- EN** With the potentiometer (3) the output value can be set: (0-10V or 0-20mA or 4-20mA)
- FR** Le potentiomètre (3) permet de régler la valeur de sortie: (0-10V ou 0-20mA ou 4-20mA)

**0 - ausgeschaltet/ switched off/ désactivé:**

- DE** Der Wandler ist am Ausgang ausgeschaltet, das heißt: 0V oder 0mA oder 4mA.
- EN** The converter is switched off at the output, that means: 0V or 0mA or 4mA.
- FR** Le convertisseur est désactivé à la sortie, c'est-à-dire: 0V ou 0mA ou 4mA.

**A - Automatik/ Automatic/ Automatique:**

- DE** Hier wird der Eingangswert automatisch in den Ausgangswert umgewandelt.
- EN** Here the input value is automatically converted to the output value.
- FR** Ici, la valeur d'entrée est automatiquement convertie en valeur de sortie.

Range adjustment

S1	Input
● → Switch On	1 2 3 4
0-10V*	●
0-20mA	●
4-20mA	● ●

S1	Output
● → Switch On	5 6
0-10V*	●
0-20mA	●
4-20mA	● ●

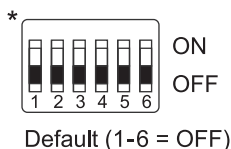

Switch position

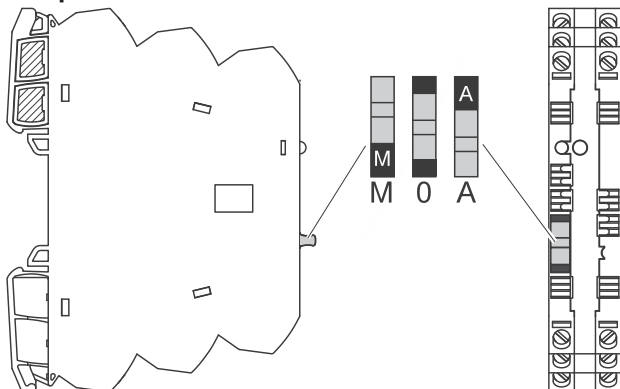

- M:** **DE** Ausgangssignal wird durch Potentiometer bestimmt  
**EN** Output signal determined by potentiometer  
**FR** Signal de sortie déterminé par potentiomètre
- 0:** **DE** Ausgangssignal auf Minimum  
**EN** Output signal at low level  
**FR** Signal de sortie à bas niveau
- A:** **DE** Ausgangssignal wird durch Eingangssignal bestimmt  
**EN** Output signal is determined by the input signal  
**FR** Le signal de sortie est déterminé par le signal d'entrée